

ISSUE 5 REVISION 2
OCTOBER 2016

ARIANE 5

USER'S MANUAL

Ariane 5

User's Manual Issue 5 Revision 2

Issued and approved by Arianespace

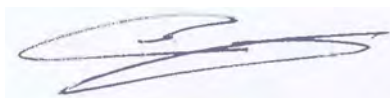

Roland LAGIER
Senior Vice president Chief technical officer



Preface

This User's Manual provides essential data on the Ariane 5 launch System, which together with the Soyuz and Vega launch vehicles, constitutes the European space transportation union.

These three launch systems are operated by Arianespace from the Guiana Space Centre (CSG).

This document contains the essential data which is necessary:

- to assess compatibility of a spacecraft and spacecraft mission with launch system,
- to constitute the general launch service provisions and specifications, and
- to initiate the preparation of all technical and operational documentation related to a launch of any spacecraft on the launch vehicle.

Inquiries concerning clarification or interpretation of this manual should be directed to the addresses listed below. Comments and suggestions on all aspects of this manual are encouraged and appreciated.

France Headquarters

Arianespace
Boulevard de l'Europe
BP 177 91006 Evry-Courcouronnes Cedex -France
Tel: +(33) 1 60 87 60 00

USA - U.S. Subsidiary

ARIANESPACE Inc.
5335 Wisconsin Avenue NW, Suite 520
DC20015 WASHINGTON, USA
Tel: +(1) 202 628-3936

Singapore – Asian Subsidiary

Arianespace
Shenton House # 25-06
3 Shenton Way
Singapore 068805

Japan - Tokyo Office

Arianespace
Kasumigaseki Building, 31Fl.
3-2-5 Kasumigaseki Chiyoda-ku
Tokyo 100-6031 - Japan

Website

www.arianespace.com

French Guiana - Launch Facilities

Arianespace
BP 809
97388 Kourou Cedex - French Guiana

This document will be revised periodically. In case of modification introduced after the present issue, the updated pages of the document will be provided on the Arianespace website www.arianespace.com before the next publication.

Foreword

Arianespace: the launch Service & Solutions Company.

Focused on customer needs

Arianespace is a commercial and engineering driven company providing complete, personalized launch services.

Through a family of powerful, reliable and flexible launch vehicles operated from the spaceport in French Guiana, Arianespace provides a complete range of lift capabilities with:

- Ariane 5, the heavy lift workhorse for missions to geostationary transfer orbit (GTO), providing through our dual launch policy the best value for money,
- Soyuz, the Ariane 5 complement for GTO missions with satellites in the three metric ton-class, also perfectly suited for medium mass missions to low earth and earth escape orbits, and
- Vega offering an affordable launch solution for small to medium missions to a range of orbits.

Arianespace combines low risk and flight proven launch systems with financing, insurance and back-up services to craft tailor-made solutions for start-ups and established players.

With offices in the United States, Japan, Singapore and Europe, and our state-of-the-art launch facilities in French Guiana, Arianespace is committed to forging service packages that meet Customer's requirements.

An experienced and reliable company

Arianespace was established in 1980 as the world's first commercial space transportation company. With over 35 years' experience, Arianespace is the most trusted commercial launch services provider chosen by more than 270 customers. Arianespace competitiveness is demonstrated by the market's largest order book that confirms the confidence of Arianespace worldwide customers. Arianespace has processing and launch experience with all commercial satellite platforms as well as with highly demanding scientific missions.

A dependable long term partner

Backed by the European Space Agency (ESA) and the resources of its 21 corporate shareholders, France's Space Agency (CNES) and Europe's major aerospace companies, Arianespace combines the scientific and technical expertise of its European industrial partners to provide world-class launch services. Continued political support for European access to space and international cooperation agreements with Russia at state level ensure the long term stability and reliability of the Arianespace family of launch vehicles.

With its family of launch vehicles, Arianespace is the reference service providing: launches of any mass, to any orbit, at any time.

Configuration Control Sheet

Issue/Rev.	Date	New Sheets	Approval
1	March 91	All	J. Breton
2	May 94	All	J. Breton
2/1	March 96	0.11, 2.2, 2.3, 2.4, 2.5, 3.10, 3.15, 4.3, 4.5, 4.7, 4.9, 4.10, 5.2., 5.3, 5.4, 5.5, 5.6, 5.7, 5.8, 6.1, 6.2, 6.3, 6.4, 6.5, 6.6, 8.12, 8.15, 8.16, 8.17, A3.1.1, A3.1.3, A3.1.4, A3.1.5, A3.1.6, A3.1.7, A3.2.4, A4.1.2, A4.1.4, A4.1.5, A4.1.6, A4.1.7, A4.1.9, A4.1.12, A4.1.13, A4.1.14, A4.1.15, A4.2.2, A4.2.4, A2.5, A4.2.6, A4.2.7, A4.2.9, A4.2.10, A4.2.11, A4.2.12, A4.2.13, A4.3.2, A4.3.4, A4.3.6, A4.3.7, A4.3.8, A4.3.10, A4.3.11, A4.3.12, A4.3.13, A4.4.2, A4.4.4, A4.4.5, A4.4.6, A4.4.7, A4.4.8, A4.4.9, A4.4.10, A4.4.11, A4.4.12, A4.4.13, A4.5.2, A4.5.4, A4.5.5, A4.5.6, A4.5.7, A4.5.8, A4.5.9, A4.5.10, A4.5.11	J. Breton
2/2	February 98	0.1, 0.4, 3.2, 4.4, 4.5, 4.6, 4.7 (a), 4.7 (b), 4.7 (c), 5.8, 8.30	J. Breton
3/0	March 00	All	J. Breton
4/0	November 04	All	J. Breton
5/0	July 08	All PMs: 51002/PP; 51114/PP; 51115/PP; 51131/PP; 51132/PP; 51175/PP; 51176/PP; 51195/PP; 51202/PP; 51216/PP; 51220/PP; 51233/PP; 51313/PP; 51334/PP; 51335/PP; 51337/PP; 51341/PP; 51344/PP; 51352/PP; 51353/PP; 51358/PP; 51362/PP; 51363/PP; 51364/PP; 51368/PP; 51374/PP; 51375/PP; 51382/PP; 51383/PP; 51408/PP; 51410/PP; 51414/PP; 51426/PP; 51427/PP	J. Breton
5/1	July 11	PMs: 51683/PP; 51804/PP; 51807/PP; 51809/PP; 51464/PP; 51853/PP; 51905/PP; 51904/PP; 51913/PP; 51917/PP; 51916/PP; 51915/PP; 51914/PP; 51926/PP; 51940/PP.	J. Thiéry

Issue/Rev.	Date	New Sheets	Approval
5/2	October 16	PMs: 52284/PP; 52289/PP; 52367/PP; 52535/PP; 52536/PP; 52537/PP; 52538/PP; 52546/PP; 52547/PP; 52539/PP; 52540/PP; 52541/PP; 52542/PP; 52543/PP; 52544/PP; 52545/PP; 52599/PP; 52600/PP; 52601/PP; 52637/PP; 52638/PP; 52660/PP.	V. Gorel J. Thiéry

Table of contents

Preface
Foreword
Configuration control sheet
Table of contents
Acronyms, abbreviations and definitions

CHAPTER 1. INTRODUCTION

1.1. Purpose of the User's Manual
1.2. European Space Transportation System
1.3. Arianespace launch services
1.4. Ariane launch vehicle family - History
1.5. Launch system description
 1.5.1. Launch vehicle general data
 1.5.2. European spaceport and CSG facilities
 1.5.3. Launch service organisation
1.6. Corporate organization
 1.6.1. Arianespace
 1.6.2. Partners
 1.6.3. European space transportation system organization
 1.6.4. Main suppliers
 1.6.4.1. Airbus Safran Launchers (ASL)
 1.6.4.2. RUAG Space

CHAPTER 2. PERFORMANCE AND LAUNCH MISSION

2.1. Introduction
2.2. Performance definition
2.3. Typical mission profile
2.4. General performance data
 2.4.1. Geosynchronous transfer orbit missions
 2.4.2. SSO and polar circular orbits
 2.4.3. Elliptical orbit missions
 2.4.4. Earth escape missions
 2.4.5. International Space Station orbit
2.5. Injections accuracy
2.6. Mission duration
2.7. Launch windows
 2.7.1. Definitions
 2.7.2. Process for launch window definition

- 2.7.3. Launch window for GTO dual launches**
- 2.7.4. Launch window for GTO single launches**
- 2.7.5. Launch window for non GTO launches**
- 2.7.6. Launch postponement**
- 2.7.7. Engine shutdown before lift-off**
- 2.8. Spacecraft orientation during the ascent phase**
- 2.9. Separation conditions**
 - 2.9.1. Orientation performance**
 - 2.9.2. Separation mode and pointing accuracy**
 - 2.9.2.1. Three axis stabilized mode
 - 2.9.2.2. Spin stabilized mode
 - 2.9.3. Separation linear velocities and collision risk avoidance**
 - 2.9.4. Multi-separation capabilities**

CHAPTER 3. ENVIRONMENTAL CONDITIONS

3.1. General

3.2. Mechanical environment

- 3.2.1. Static acceleration**
 - 3.2.1.1. On ground
 - 3.2.1.2. In flight
- 3.2.2. Steady state angular motion**
- 3.2.3. Sine-equivalent dynamics**
- 3.2.4. Random vibration**
- 3.2.5. Acoustic vibration**
 - 3.2.5.1. On ground
 - 3.2.5.2. In flight
- 3.2.6. Shocks**
- 3.2.7. Static pressure under the fairing**
 - 3.2.7.1. On ground
 - 3.2.7.2. In flight

3.3. Thermal environment

- 3.3.1. Introduction**
- 3.3.2. Ground operations**
 - 3.3.2.1. CSG facility environments
 - 3.3.2.2. Thermal condition under the fairing or the SYLDA 5
- 3.3.3. Flight environment**
 - 3.3.3.1. Thermal conditions before fairing jettisoning
 - 3.3.3.2. Aerothermal flux and thermal conditions after fairing jettisoning
 - 3.3.3.3. Other fluxes

3.4. Cleanliness and contamination

- 3.4.1. Cleanliness level in environment**
- 3.4.2. Deposited contamination**
 - 3.4.2.1. Particulate contamination
 - 3.4.2.2. Organic contamination

3.5. Electromagnetic environment

- 3.5.1. L/V and range RF systems**
- 3.5.2. The electromagnetic field**

3.6. Environment verification

CHAPTER 4. SPACECRAFT DESIGN AND VERIFICATION REQUIREMENTS

4.1. Introduction

4.2. Design requirements

4.2.1. Safety requirements

4.2.2. Selection of spacecraft materials

4.2.3. Spacecraft properties

4.2.3.1. Payload mass and CoG limits

4.2.3.2. Static unbalance

4.2.3.3. Dynamic unbalance

4.2.3.4. Frequency requirements

4.2.4. Dimensioning loads

4.2.4.1. The design load factors

4.2.4.2. Line loads peaking

4.2.4.3. Handling loads during ground operations

4.2.4.4. Dynamic loads

4.2.5. Spacecraft RF emission

4.3. Spacecraft compatibility verification requirements

4.3.1. Verification logic

4.3.2. Safety factors

4.3.3. Spacecraft compatibility tests

4.3.3.1. Static tests

4.3.3.2. Sinusoidal vibration tests

4.3.3.3. Acoustic vibration tests

4.3.3.4. Shock qualification

CHAPTER 5. SPACECRAFT INTERFACES

5.1. Introduction

5.2. The reference axes

5.3. Encapsulated spacecraft interfaces

5.3.1. Payload usable volume definition

5.3.2. Spacecraft accessibility

5.3.3. Special on-fairing insignia

5.3.4. Payload compartment description

5.4. Mechanical interfaces

5.5. Electrical and radio electrical interfaces

5.5.1. Spacecraft to EGSE umbilical lines

5.5.2. The L/V to spacecraft electrical functions

5.5.2.1. Dry loop command

5.5.2.2. Electrical command

5.5.2.3. Spacecraft telemetry transmission

5.5.2.4. Power supply to spacecraft

5.5.2.5. Pyrotechnic command

5.5.3. Electrical continuity interfaces (bonding and shielding)

5.5.4. RF communication link between spacecraft and the EGSE

5.6. Interface verifications

5.6.1. Prior to the launch campaign

5.6.2. Pre-launch validation of the electrical interface

5.6.2.1. Definition

5.6.2.2. Spacecraft EGSE

CHAPTER 6. GUIANA SPACE CENTRE

6.1. Introduction

6.1.1. French Guiana

6.1.2. The European spaceport

6.2. CSG general presentation

6.2.1. Arrival areas

6.2.1.1. Félix Eboué international airport

6.2.1.2. Cayenne harbor

6.2.1.3. The Pariacabo docking area

6.2.2. Payload preparation complex (EPCU)

6.2.2.1. S1 Payload Processing Facility

6.2.2.2. S3 Hazardous Processing Facility

6.2.2.3. S5 Payload Processing & Hazardous Facility

6.2.3. Facilities for combined and launch operations

6.2.3.1. Ariane launch site (ELA3 "Ensemble de Lancement Ariane n° 3")

6.2.3.1.1. Final Assembly building (BAF "Bâtiment d'Assemblage Final")

6.2.3.1.2. Launch Table

6.2.3.1.3. Ariane Launch Pad (ZL3 "Zone de lancement n° 3")

6.2.3.1.4. Launch Control Centre (CDL3 "Centre de lancement n° 3")

6.2.3.2. Mission Control Centre – Technical Centre

6.3. CSG General Characteristics

6.3.1. Environmental conditions

6.3.1.1. Climatic conditions

6.3.1.2. Temperature, humidity and cleanliness in the facilities

6.3.1.3. Mechanical environment

6.3.2. Power supply

6.3.3. Communications network

6.3.3.1. Operational data network

6.3.3.2. Range communication network

6.3.3.3. Range information systems

6.3.4. Transportation and handling

6.3.5. Fluids and gases

6.4. CSG Operations policy

6.4.1. CSG planning constraints

6.4.2. Security

6.4.3. Safety

6.4.4. Training course

6.4.5. Customer assistance

6.4.5.1. Visas and access authorization

6.4.5.2. Customs clearance

6.4.5.3. Personnel transportation

6.4.5.4. Medical care

6.4.5.5. VIP accommodation

6.4.5.6. Other assistance

CHAPTER 7. MISSION INTEGRATION AND MANAGEMENT

7.1. Introduction

7.2. Mission management

7.2.1. Contract organization

7.2.2. Mission integration schedule

7.3. Launch vehicle procurement and adaptation

7.3.1. Procurement/Adaptation process

7.3.2. L/V flight readiness review (RAV "Revue d'Aptitude au Vol ")

7.4. System engineering support

7.4.1. Interface management

7.4.2. Mission analysis

7.4.2.1. Introduction

7.4.2.2. Preliminary mission analysis

7.4.2.2.1. Preliminary trajectory, performance and injection accuracy analysis

7.4.2.2.2. Preliminary spacecraft separation and collision avoidance analysis

7.4.2.2.3. Preliminary dynamic coupled load analysis

7.4.2.2.4. Preliminary electromagnetic and RF compatibility analysis

7.4.2.3. Final mission analysis

7.4.2.3.1. Final trajectory, performance and injection accuracy analysis

7.4.2.3.2. Final spacecraft separation and collision avoidance analysis

7.4.2.3.3. Final dynamic coupled load analysis

7.4.2.3.4. Final electromagnetic and RF compatibility analysis

7.4.2.3.5. Thermal analysis

7.4.3. Spacecraft design compatibility verification

7.4.4. Post-launch analysis

7.4.4.1. Injection parameters

7.4.4.2. Flight synthesis report (DEL " Dossier d'Evaluation du Lancement ")

7.5. Launch campaign

7.5.1. Introduction

7.5.2. Spacecraft launch campaign preparation phase

7.5.2.1. Operational documentation

7.5.2.1.1. Application to use Arianespace's launch vehicles (DUA " Demande d'Utilisation Arianespace ")

7.5.2.1.2. Spacecraft operations plan (POS)

7.5.2.1.3. Interleaved operations plan (POI)

7.5.2.1.4. Combined operations plan (POC)

7.5.2.1.5. Detailed procedures for combined operations

7.5.2.1.6. Countdown Manual

7.5.3. Launch campaign organization

7.5.3.1. Spacecraft launch campaign management

7.5.3.2. Launch countdown organization

7.5.4. Launch campaign meetings and reviews

7.5.4.1. Introduction

7.5.4.2. Spacecraft preshipment review

7.5.4.3. Spacecraft transport meeting

7.5.4.4. EPCU acceptance review

7.5.4.5. Combined operations readiness review (BT POC " Bilan Technique POC ")

7.5.4.6. Preliminary launch readiness review

7.5.4.7. Launch readiness review (RAL "Revue d'Aptitude au Lancement")

7.5.4.8. Post flight debriefing (CRAL " Compte-Rendu Après le Lancement ")

7.5.4.9. Launch service wash-up meeting

7.5.5. Summary of a typical launch campaign

7.5.5.1. Launch campaign time line and scenario

7.5.5.2. Spacecraft autonomous preparation

7.5.5.2.1. Phase 1: Spacecraft arrival preparation and check-out

7.5.5.2.2. Phase 2: Spacecraft hazardous operations

7.5.5.3. Launch vehicle processing

7.5.5.4. Combined operations

7.6. Safety assurance

7.6.1. General

7.6.2. Safety submission

7.6.3. Safety training

7.6.4. Safety measures during hazardous operations

7.7. Quality assurance

7.7.1. Arianespace's Quality Assurance system

7.7.2. Customized quality reporting (optional)

7.8. Environmental footprint management

Annex 1	Application to use Arianespace's launch vehicle (DUA)
Annex 2	Reviews and documentation checklist
Annex 3	Items and services for an Arianespace launch
Annex 4	Ariane 5ECA description
Annex 5	Usable volume under fairing and SYLDA5
Annex 6	Spacecraft accessibility and radio communications
Annex 7	Adapter Ø937 mm
Annex 8	Adapter Ø1194 mm
Annex 9	Payload Adapter System 1663
Annex 10	Payload Adapter System 1666MVS
Annex 11	Payload Adapter System 1666S
Annex 12	Payload Adapter System 2624VS

Acronyms, abbreviations and definitions

ω_p	Argument of perigee
Ω	Ascending node
Ω_D	Descending node
a	Semi-major axis
e	Eccentricity
g	Gravity (9.81 m/s ²)
i	Inclination
V_∞	Infinite velocity
Z_a, h_a	Apogee altitude
Z_p, h_p	Perigee altitude

A

ACS	A ttitude C ontrol S ystem	
ACU	Payload adaptor	A daptateur C harge U tile
	Payload deputy	A ssistant C harge U tile
ACY	Raising Cylinder	A daptateur C ylindrique
AE	A rianespace	
AMF	A pogee M otor F iring	
ARS	Satellite ground stations network Assistant	A djoint R éseau S tations sol Satellite
ASAP	A riane S tructure for A uxiliary P ayload	
ASL	A irbus S afran L aunchers	
ATV	A utomated T ransfer V ehicle	

B

BAF	Final Assembly Building	B âtiment d' A ssemblage F inal
BAF/HE	Encapsulation Hall of BAF	H all d' E ncapsulation du B AF
BB	B ase B and	
BIL	L/V integration building	B âtiment d' I ntégration L anceur
BIP	Boosters integration building	B âtiment d' I ntégration P ropulseurs
BT POC	Combined operations readiness review	B ilan T echnique P lan d' O érations C ombinées

C

CAD	C omputer A ided D esign	
CCTV	C losed C ircuit T elevision network	
CCU	Payload Container	C ontainer C harge U tile
CDC	Mission control centre	C entre d e C ontrôle
CDL	Launch Centre	C entre d e L ancement
CFRP	C arbon F ibre R einforced P lastic	
CG/D	Range director	
CLA	C oupled L oads A nalysis	
CM	Mission Director	C hef de M ission
CNES	French National Space Agency	C entre N ational d' E tudes S patiales

COEL	Launch Site Operations Manager	C hef des O pérations E nsemble de L ancement
CoG	C enter of G ravity	
COTE	C heck- O ut T erminal E quipment	
CP	Program Director	C hef de P rojet
CPAP	Ariane Production Project Manager	C hef de P rojet A rianespace P roduction
CPS	Spacecraft project manager	C hef de P rojet S atellite
CQCL	AE Launch Campaign Quality Manager	C hef Q ualité C ampagne de L ancement
CRAL	Post flight debriefing	C ompte R endu A près L ancement
CSG	Guiana Space Centre	C entre S patial G uyanais
CTS	C SG T elephone S ystem	
CU	Payload	C harge U tile
CVCM	C ollected V olatile C ondensed M ass	
D		
DCI	Interface control document	D ocument de C ontrôle d' I nterface
DDO	Range operations manager	D irecteur des O pérations
DEL	Flight synthesis report	D ossier d' E valuation du L ancement
DMS	Spacecraft mission director	D irecteur de la M ission S atellite
DOM	French overseas department	D épartement d' O utre- M er
DUA	Application to use Arianespace's L/V	D emande d' U tilisation A rianespace
E		
EAP	Solid rocket booster	E tage d' A ccélération à P oudre
ECSS	E uropean C ooperation for S pace S tandardization	
EGSE	E lectrical G round S upport E quipment	
ELA	Ariane launch site	E nsemble de L ancement A riane
ELS	Soyuz launch site	E nsemble de L ancement S oyuz
ELV	ELV S.p.A. (E uropean L aunch V ehicle)	
EM	E lectro M agnetic	
EMC	E lectro M agnetic C ompatibility	
EPC	Cryogenic main core stage	E tage P rincipal C ryotechnique
EPCU	Payload preparation complex	E nsemble de P réparation C harge U tile
EPS	Storable propellant stage	E tage à P ropergols S tockables
ESA	E uropean S pace A gency	
ESC	Cryogenic upper stage	E tage S upérieur C ryotechnique
F		
FM	F light M odel	
G		
GEO	G eosynchronous E quatorial O rbital	
GH ₂	G aseous hydrogen	
GN ₂	G aseous nitrogen	
GO ₂	G aseous oxygen	
GRS	G eneral R ange S upport	
GSE	G round S upport E quipment	

	GTO	Geostationary Transfer Orbit	
H			
	HEPA	High Efficiency Particulate Air	
	HEO	High Elliptical Orbit	
	HPF	Hazardous Processing Facility	
	HSS	Horizontal Separation Subsystem	
I			
	ISCU	Payload safety officer	Ingénieur Sauvegarde Charge Utile
	ISLA	Launch area safety officer	Ingénieur Sauvegarde Lancement Arianespace
	ISS	International Space Station	
		InterStage Structure	
K			
	KRU	Kourou	
L			
	LAN	Local Area Network	
	LBC	Check out equipment room	Local Banc de Contrôle
	LEO	Low-Earth Orbit	
	LH ₂	Liquid Hydrogen	
	LIA	Automatic inter link	Liaison Inter Automatique
	LOX	Liquid oxygen	
	LSA	Launch Service Agreement	
	L/V	Launch Vehicle	
	LVA	Launch Vehicle Adapter	
	LW	Launch Window	
M			
	MCC	Mission Control Centre	
	MCI	Mass, Center of Gravity, Inertia	
	MEO	Medium-Earth Orbit	
	MEOP	Maximum Expected Operating Pressure	
	MGSE	Mechanical Ground Support Equipment	
	MUA	Ariane user's manual	Manuel Utilisateur Ariane
	MULTIFOS		MULTIplex Fibres Optiques Satellites
N			
	NA	Not Applicable	
O			
	OASPL	Overall Acoustic Sound Pressure Level	
	OBC	On Board Computer	
	OCOE	Overall Check Out Equipment	
P			
	PABX	Private Automatic Branch eXchange	
	PAF	Payload Attachment Fitting	
	PAS	Payload Adapter System	
	PDG	Chairman & Chief Executive Officer	Président Directeur Général
	PFCU	Payload access platform	Plate-Forme Charge Utile

PFM	Proto-Flight Model	
PLANET	Payload Local Area Network	
POC	Combined operations plan	Plan d'Opérations Combinées
POE	Electrical umbilical plug	Prise Ombilicale Electrique
POI	Interleaved spacecraft operations plan	Plan d'Opérations Imbriquées
POP	Pneumatic umbilical plug	Prise Ombilicale Pneumatique
POS	Spacecraft operations plan	Plan d'Opérations Satellite
PPF	Payload Preparation Facility	
PRS	Passive Repeater System	
Q		
QA	Quality Assurance	
QSL	Quasi-Static Load	
QSM	Quality Status Meeting	
QSP	Quality System Presentation	
QSR	Quality Status Report	
R		
RAAN	Right Ascension of the Ascending Node	
RAL	Launch readiness review	Revue d'Aptitude au Lancement
RAMF	Final mission analysis review	Revue d'Analyse de Mission Finale
RAMP	Preliminary mission analysis review	Revue d'Analyse de Mission Préliminaire
RAV	Launch vehicle flight readiness review	Revue d'Aptitude au Vol
RF	Radio Frequency	
RMCU	Payload facilities manager	Responsable des Moyens Charge Utile
ROMULUS	Multiservices operational network	Réseau Opérationnel MULTiservice à Usage Spatial
RPS	Spacecraft preparation manager	Responsable de la Préparation Satellite
RQLP	AE L/V Production Quality Manager	Responsable Qualité Lanceur en Production
RSG	Ground safety officer	Responsable Sauvegarde Sol
RSV	Flight safety officer	Responsable Sauvegarde Vol
RTW	Radio Transparent Window	
S		
S/C	Spacecraft	
SCA	Attitude control system	Système de Contrôle d'Attitude
SHOGUN	SHOCK Generation UNit	
SIW	Satellite Injection Window	
SLV	Vega launch site	Site de Lancement Vega
SOW	Statement of Work	
SRB	Solid Rocket Booster	Etage d'Accélération à Poudre (EAP)
SRP	Passive repeater system	Système Répéteur Passif
SSO	Sun-Synchronous Orbit	
STFO	Optic fibre transmission system	Système de Transmission par Fibre Optique
STM	Structural Test Model	
SYLDA5	Payload internal carrying structure	SYstème de Lancement Double Ariane 5

T

TBC	To Be Confirmed	
TBD	To Be Defined	
TC	Telecommand	
TD	Countdown time	Temps Décompte
TM	Telemetry	
TS	Telephone System	
TV	Television	

U

USR	Upper Stiffening Rib	
UTC	Universal Time Coordinated	

V

VEB	Vehicle Equipment Bay	
VSS	Vertical Separation Subsystem	
VLAN	Virtual Local Area Network	

Z

ZL	Launch pad	Zone de Lancement
ZLV	VEGA Launch pad	Zone de Lancement VEGA
ZLS	Soyuz Launch pad	Zone de Lancement SOYUZ
ZSE	Propellant storage area	Zone de Stockage d'Ergols
ZSP	Pyrotechnic storage area	Zone de Stockage Pyrotechnique

Introduction

Chapter 1

1.1. Purpose of the User's Manual

This User's Manual is intended to provide basic information on the Arianespace's launch services solution using the Ariane 5 launch system operated from the Guiana Space Centre along with Soyuz and Vega launch systems.

The content encompasses:

- the Ariane 5 launch vehicle description,
- performance and launch vehicle mission,
- environmental conditions imposed by the L/V, and corresponding requirements for spacecraft design and verification,
- description of interfaces between spacecraft and launch vehicle,
- payload processing and ground operations performed at the launch site,
- mission integration and management, including support carried out throughout the duration of the launch contract.

Together with the Payload Preparation Complex Manual (EPCU User's Manual) and the CSG Safety Regulations it gives readers sufficient information to assess the suitability of the Ariane 5 L/V and its associated launch services to perform their mission and to assess the compatibility with the proposed launch vehicle. On completion of the feasibility phase, formal documentation will be established in accordance with the procedures outlined in chapter 7 of this Manual.

For more detailed information, the reader is encouraged to contact Arianespace.

1.2. European Space Transportation System

To meet all customers' requirements and to provide the highest quality of services, Arianespace proposes to customer a fleet of launch vehicles: Ariane, Soyuz and Vega. Thanks to their complementarities, they cover all commercial and governmental missions' requirements, providing access to the different types of orbit from Low Earth Orbit to Geostationary Transfer Orbit, and even to interplanetary one. This family approach provides customers with a real flexibility to launch their spacecraft, and insure in a timely manner their planning for in-orbit delivery.

The Ariane 5 market is mainly focused on large-weight spacecraft class for low earth orbit and geostationary transfer orbit. It is completed by the Soyuz and Vega offers for medium and low-weight spacecraft classes.

The exclusive exploitation of this launch vehicle family was entrusted to Arianespace – a unique launch services operator relying on the European and Russian space industry.

The customer will appreciate the advantages and possibilities brought by the present synergy, using a unique high quality rated launch site, a common approach to the L/V-spacecraft suitability and launch preparation, and the same quality standards for mission integration and management.

1.3. Arianespace launch services

Arianespace offers to its customers reliable and proven launch services that include:

- Exclusive marketing, sales and management of Ariane 5, Ariane 6, Soyuz, Vega and Vega C,
- Mission management and support that cover all aspects of launch activities and preparation from contract signature to launch,
- Systems engineering support and analysis,
- Procurement and verification of the launch vehicle and all associated hardware and equipment, including all adaptations required to meet customer requirements,
- Ground facilities and support (GRS) for customer activities at launch site,
- Combined operations at launch site, including launch vehicle and spacecraft integration and launch,
- Telemetry and tracking ground station support and post-launch activities,
- Assistance and logistics support, which may include transportation and assistance with insurance, customs, and export licenses,
- Quality and safety assurance activities,
- Insurance and financing services on a case by case basis.



Arianespace provides the customer with a project oriented management system, based on a single point of contact (the Program Director) for all launch service activities, in order to simplify and streamline the process, adequate configuration control for the interface documents and hardware, and transparency of the launch system to assess the mission progress and schedule control.

1.4. Ariane launch vehicle family – History

Ariane 1, 2, 3

The Ariane launch system is an example of European political, economic and technical cooperation at its best.

In a world where instant communication and the use of satellites in mobile communication, television broadcasting, meteorology, earth observation and countless other fields are almost taken for granted, the story of Ariane is worth telling. From its beginning in 1973 up to the first decades of the 21st century, Ariane is continuously suited to the market.

More than three decades ago, European politicians, scientists and industrialists felt the need of Europe to secure its own unrestricted access to space. They wanted a cost-effective, reliable, unmanned workhorse that would provide affordable access to space. In 1973, European Ministers made a bold decision to develop the Ariane launch system.

The development program was placed under the overall management of the European Space Agency (ESA) working with the French National Space Agency (CNES) as prime contractor.

The maiden flight of Ariane 1 took place on 24 December 1979. Ariane 1 successfully launched several European and non-European spacecraft, including Spacenet 1 for the first US customer. Ariane 1's payload capacity of 1,800 kg to GTO was soon proven insufficient for the growing telecommunication satellites.

In the early 1980s, Ariane 1 was followed by its more powerful derivatives, Ariane 2 with a payload of 2,200 kg to GTO, and Ariane 3, which made its first flight in 1984 and could carry a payload of 2,700 kg. Ariane 3 could launch two spacecraft at a time allowing the optimization of the launch configurations.

Ariane 4

Development of the more powerful Ariane 4 received the go-ahead in April 1982. The first Ariane 4 was launched in 1988.

Ariane 4 came in six variants with various combinations of solid or liquid strap-on boosters. Thus Ariane 4 was easily adaptable to different missions and payloads. Its maximum lift capacity was of 4,800 kg to GTO.

Ariane 4 has proven its reliability with 74 consecutive successful flights from January 1995 to February 2003 and consolidated Europe's position in the market despite stiff international competition.

Ariane 5

In 1987, European Ministers agreed to develop Ariane 5, an even more powerful launcher based on a rather different architecture.

Initially man rated, Ariane 5 incorporates a high level of redundancy in its electrical and computer systems for greater reliability.

It also uses more standardized components than its predecessors. Ariane 5 represents a qualitative leap in launch technology. Two solid rocket boosters provide 90 percent of Ariane 5's thrust at lift-off. A cryogenic core stage, ignited and checked on ground, provides the remaining thrust for the first part of the flight up to the upper stage separation.

Ariane 5 is equipped with a cryogenic upper stage (see a more detailed description in the following section) powered by the Ariane 4 cryogenic engine.

Able to place heavy payloads in GTO, Ariane 5 is also ideally suited for launching the space tugboat or Automated Transfer Vehicle (ATV) towards the International Space Station.

Through its long experience, Arianespace operated shared and dedicated launches, for all types of missions, geostationary transfer orbits, circular polar orbits, inclined orbits and escape missions.

With the Ariane family, Arianespace experience is as of end of 2015, of nearly 380 launch contracts signed, 227 flights, 349 satellites launched (thanks to the shared launch capability), 53 auxiliary payloads launched, over a period of 35 years.



Figure 1.4.a - Ariane Launch family

Following the decision taken during the December 2014 ESA Ministerial Council, ESA and European industry are currently developing a new-generation launcher: Ariane 6. This launcher aims at maintaining Europe's leadership in the fast-changing commercial launch service market while responding to the needs of European institutional missions.

1.5. Launch system description

Arianespace offers a complete launch system including the vehicle, the launch facilities and the associated services.

1.5.1. Launch vehicle general data

The launch vehicle is basically the Ariane two-stage-vehicle with solid strap-on boosters. Depending on the required performance and the composition of its payload, one of several launch configurations can be selected by Arianespace based upon the utilization of different upper stages (storable propellant or cryogenic) and dual launch systems.

Arianespace continually develops solutions that meet evolving customer demand. Priority is given to provide access to space for all applications under the best conditions. Ariane 5 evolutions will provide an increased payload carrying capacity, a flexibility to perform a wide range of missions with the high reliability demonstrated throughout the Ariane program.

Thanks to the upgrades that increase the GTO capacity, Ariane's baseline mission remains the well proven dual spacecraft launch, best way to optimize the cost/performance ratio.

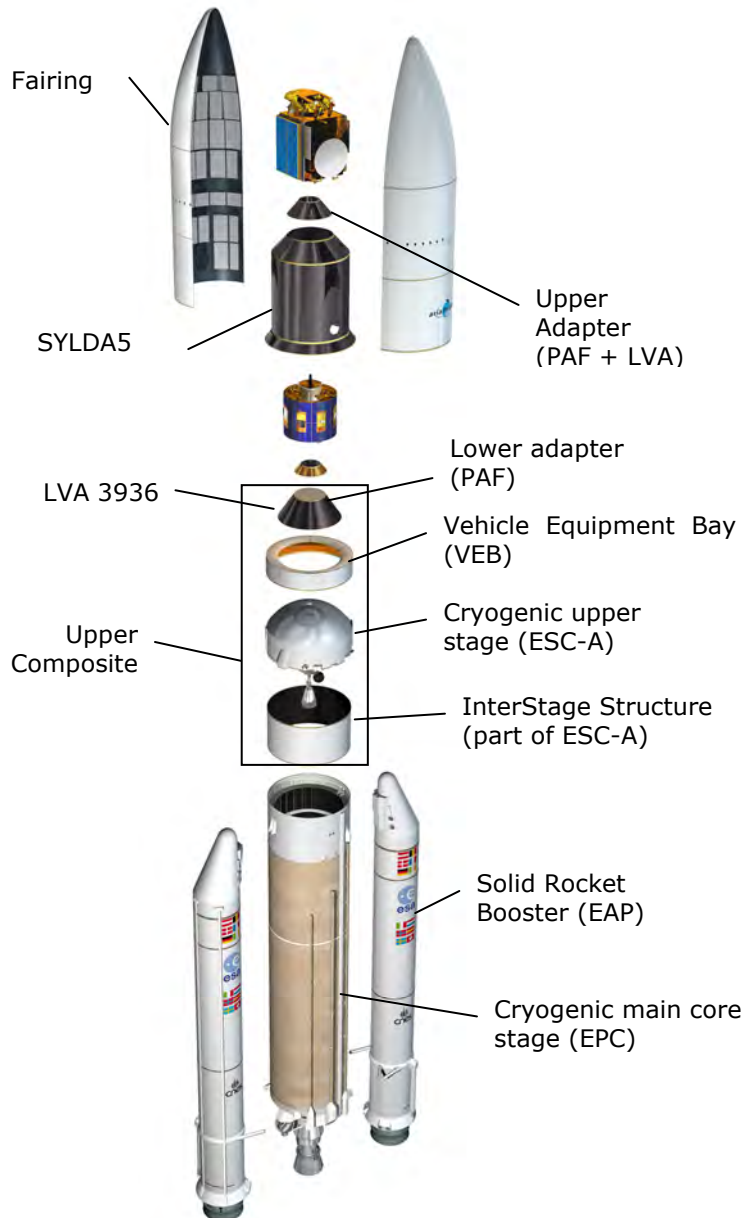

PAYLOAD FAIRING	
Diameter	5.4 m
Height	17 m
Mass	2675 kg
Structure	Two halves - Sandwich CFRP sheets and aluminium honeycomb core
Acoustic protection	Foam sheets
Separation	Horizontal and vertical separations by leak-proof pyrotechnical expanding tubes

SYLDA5	
Diameter	4.56 m
Height	Total height of standard version: 4.903 m Adjustable cylinder height : +0.3/+0.6/+0.9/+1.2/+1.5/+2.1 m w.r.t. standard
Mass	From 425 to 535 kg, depending on height
Structure	Sandwich CFRP sheets and aluminium honeycomb core
Separation	Leak-proof pyrotechnical expanding tube at the base of the cylinder

ADAPTERS off-the-shelf devices	
Clampband	Ø937 Ø1194 Ø1666 Ø2624
4 pyronuts	Ø1663

CONE 3936 or LVA 3936	
Height	783 or 1187 mm
Mass	200 or 170 kg
Structure	Monolithic CFRP cone and glass fiber membrane

VEB	
Structure	Sandwich CFRP sheets and aluminium honeycomb core
Avionics	Flight control, flight termination, power distribution and telemetry subsystems

CRYOGENIC UPPER STAGE (ESC-A)	
Size	Ø 5.4 m x 4.711 m between I/F rings
Dry mass	4540 kg
Structure	Aluminium alloy tanks
Propulsion	HM7B engine - 1 chamber
Propellants loaded	14.9 t of LOX + LH ₂
Thrust	67 kN
Isp	446 s
Feed system	1 turbo-pump driven by a gas generator
Pressurization	GHe for LOX tank and GH ₂ for LH ₂ tank
Combustion time	945 s
Attitude control powered phase	Pitch and yaw: gimbaled nozzle Roll: 4 GH ₂ thrusters
Attitude control ballistic phase	Roll, pitch and yaw : 4 clusters of 3 GH ₂ thrusters Longitudinal boost : 2 GO ₂ thrusters
Avionics	Guidance from VEB

Inter Stage Structure (ISS)	
Structure	Sandwich CFRP sheets and aluminium honeycomb core
Separation	Pyrotechnical expanding tube at the top of the ISS and 4 ullage rockets

CRYOGENIC MAIN CORE STAGE (EPC)	
Size	Ø 5.4 m x 23.8 m (without engine)
Dry mass	14700 kg
Structure	Aluminium alloy tanks
Propulsion	Vulcain 2 - 1 chamber
Propellants	170 t of LOX + LH ₂
Thrust	960 kN (SL) 1390 kN (Vacuum)
Isp	~310 s (SL) 432 s (Vacuum)
Feed system	2 turbo-pumps driven by a gas generator
Pressurization	GHe for LOX tank and GH ₂ for LH ₂ tank
Combustion time	540 s
Attitude control	Pitch and yaw: gimbaled nozzle Roll: 4 GH ₂ thrusters
Avionics	Flight control, flight termination, power distribution and telemetry subsystems, connected to VEB via data bus

SOLID ROCKET BOOSTER (EAP)	
Size	Ø 3.05 m x 31.6 m
Structure	Stainless steel case
Propulsion	Solid propellant motor (MPS)
Propellants	240 t of solid propellant per EAP
Mean thrust	7000 kN (Vacuum)
Isp	274.5 s
Combustion time	130 s
Attitude control	Steerable nozzle
Avionics	Flight control, flight termination and telemetry subsystems, connected to VEB via data bus + autonomous telemetry

1.5.2. European spaceport and CSG Facilities

The launch preparation and launch are carried out from the Guiana Space Centre (CSG) – European spaceport operational since 1968 in French Guiana. The spaceport accommodates Ariane 5, Soyuz and Vega separated launch facilities (ELA, ELS and SLV respectively) with common Payload Preparation Complex EPCU and launch support services.

The CSG is governed under an agreement between France and the European Space Agency that was extended to cover Soyuz and Vega installations. The day-to-day life of CSG is managed by French National Space Agency (Centre National d'Etudes Spatiales – CNES) on behalf of the European Space Agency. CNES provides all needed range support, requested by Arianespace, for spacecraft and launch vehicle preparation and launch.

The CSG provides state-of-the-art Payload Preparation Facilities (Ensemble de Préparation Charge Utile – EPCU) recognized as a high quality standard in space industry. The facilities are capable to process several spacecraft of different customers in the same time, thanks to large clean-rooms and supporting infrastructures. Designed for Ariane-5 dual launch capability and high launch rate, the EPCU capacity is sufficient to be shared by the Customers of all three launch vehicles.

The spacecraft/launch vehicle integration and launch are carried out from launch sites dedicated for Ariane, Soyuz or Vega.

The Ariane 5 Launch Site (Ensemble de Lancement Ariane – ELA) is located approximately 15 km to the North-West of the CSG Technical Centre (near Kourou).

The moderate climate, the regular air and sea connection, accessible local transportation, and excellent accommodation facilities for business and for recreation– all that devoted to customer's team and invest to the success of the launch mission.

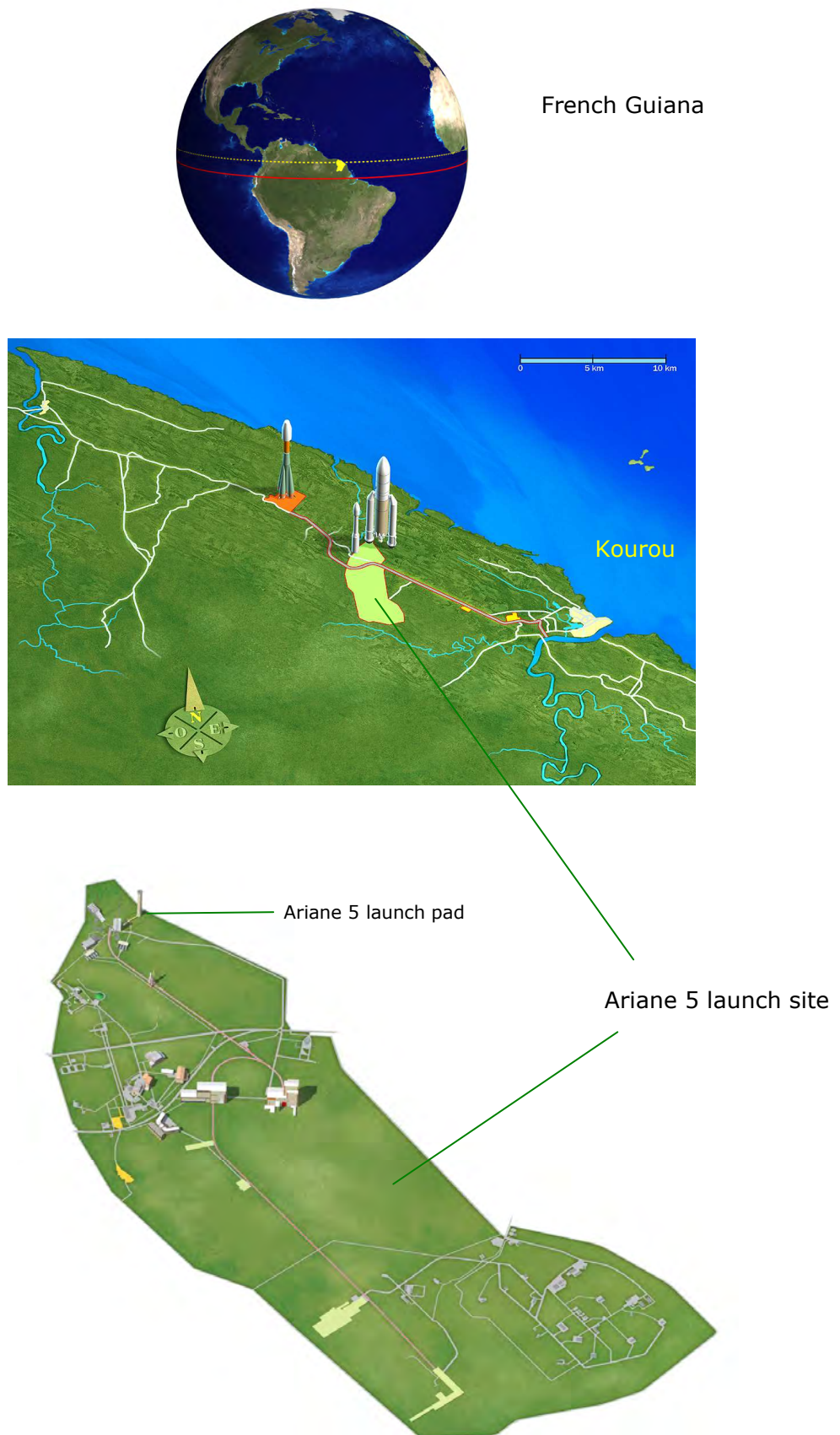

Figure 1.5.2.a – CSG overview – A5 launch site

1.5.3. Launch service organization

Arianespace is organized to offer a Launch Service based on a continuous interchange of information between a Spacecraft Interface Manager (Customer), and the Program Director (Arianespace) who is appointed at the time of the launch contract signature. As from that date, the Arianespace Program Director is responsible for the execution of the Launch Service Contract. For a given launch, therefore, there are one or two Spacecraft Interface Manager(s) and one or two Arianespace Program Directors, depending on whether the launch is a single or dual one.

For the preparation and execution of the Guiana operations, the Arianespace launch team is managed by a specially assigned Mission Director who will work directly with the customer's operational team.

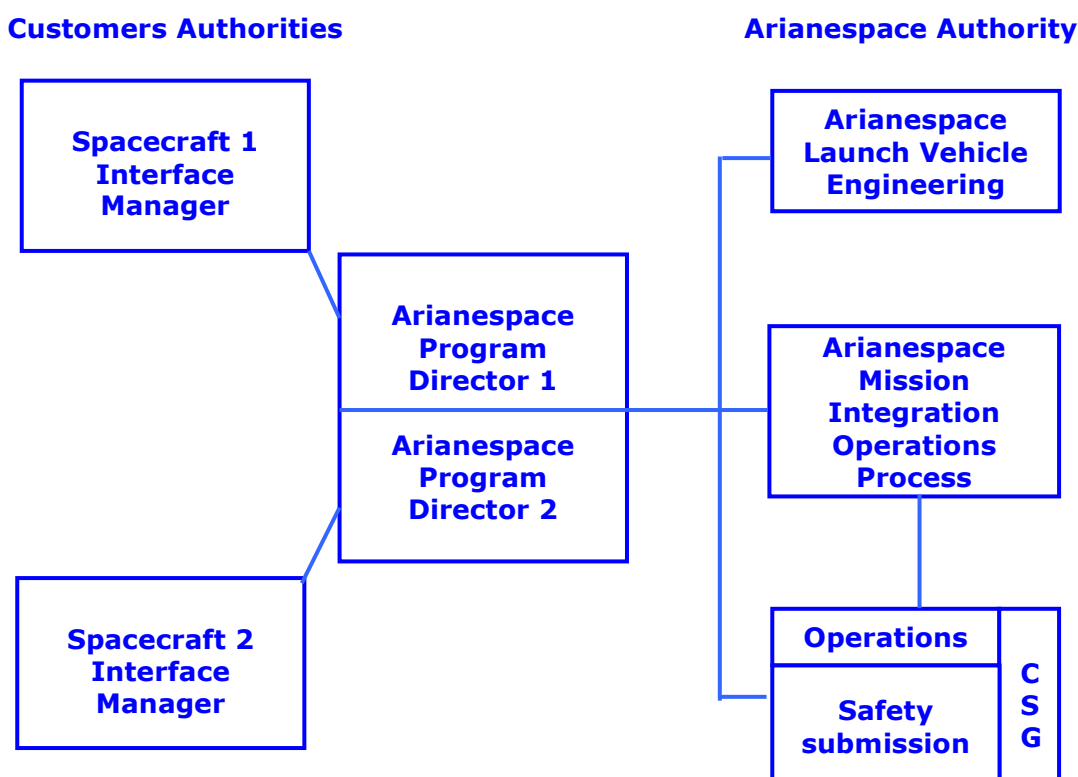

Figure 1.5.3.a - Principle of customers/Arianespace relationship

1.6. Corporate organization

1.6.1. Arianespace

Arianespace is a French joint stock company ("Société Anonyme") which was incorporated on 26 March 1980 as the first commercial space transportation company.

In order to meet the market needs, Arianespace has established a worldwide presence: in Europe, with headquarters located at Evry near Paris, France; in North America with Arianespace Inc., its subsidiary in Washington D.C., and in the Pacific Region, with its representative offices in Tokyo (Japan) and its subsidiary in Singapore.

Arianespace is the international leader in commercial launch services, and today holds an important part of the world market for satellites launched to the geostationary transfer orbit (GTO). From its creation in 1980 up to end of 2015, Arianespace has performed over 270 launches and signed contracts for nearly 590 payloads (not including Oneweb: more than 600 payload) with some 90 operators/customers.

Arianespace provides each customer a true end-to-end service, from manufacture of the launch vehicle to mission preparation at the Guiana Space Centre and successful in-orbit delivery of payloads for a broad range of missions.

Arianespace as a unique commercial operator oversees the marketing and sales, production and operation from CSG of Ariane, Soyuz and Vega launch vehicles.



Figure 1.6.1.a –Arianespace worldwide

1.6.2. Partners

Arianespace is backed by shareholders that represent the best technical, financial, and political resources of the European countries participating in the Ariane and Vega programs.

By their recent decision to start the development of a new launcher, the European governments renewed their confidence in the Ariane industrial community.

1.6.3. European space transportation system organization

Arianespace benefits from a simplified procurement organization that relies on a prime supplier for each launch vehicle. The prime supplier backed by his industrial organization is in charge of production and integration of the launch vehicle.

The prime suppliers for Soyuz and Vega launch vehicles are respectively the Russian Federal Space Agency and ELV. The prime supplier for Ariane is Airbus Safran Launchers (ASL).

Ariane, Soyuz and Vega launch operations are managed by Arianespace with the participation of the prime suppliers and range support from CNES CSG.

The figure 1.6.3.a shows the launch vehicle procurement organization.

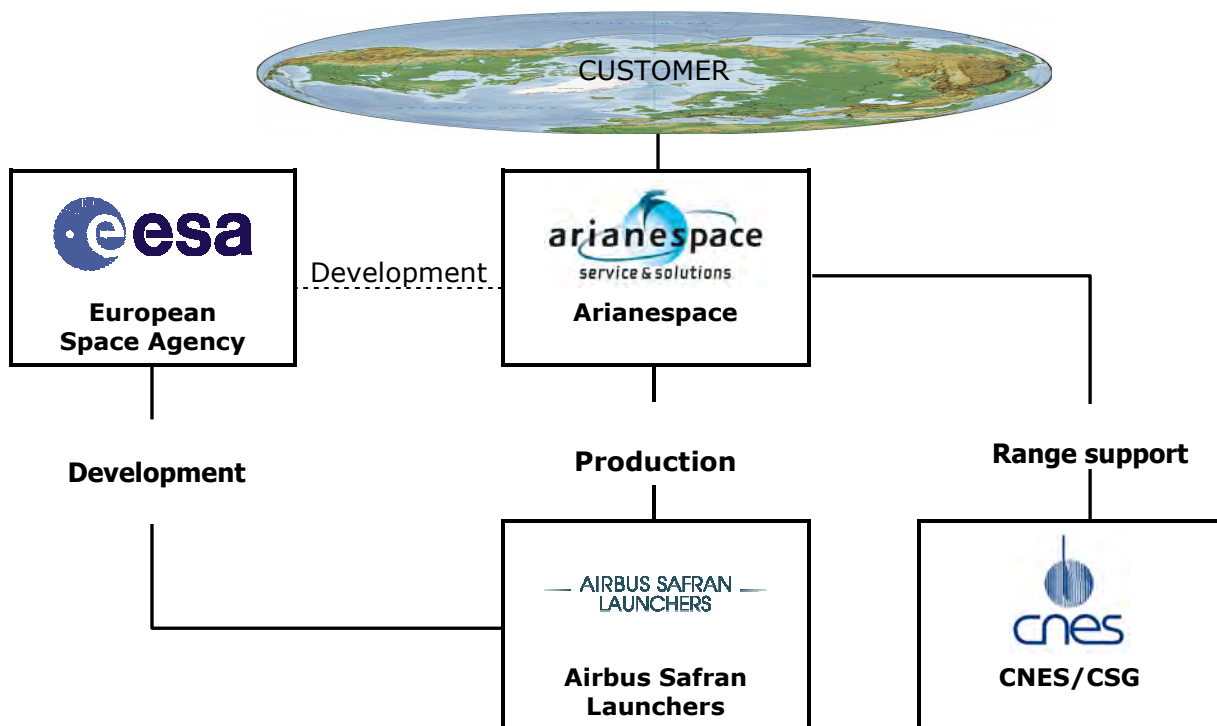

Figure 1.6.3.a – The launch vehicle procurement and range support organization

1.6.4. Main suppliers**— AIRBUS SAFRAN —
LAUNCHERS****1.6.4.1. Airbus Safran Launchers (ASL)**

Since the 1st of January 2015, Airbus and Safran have joined their forces in launcher activities and created Airbus Safran Launchers.

Airbus group is the largest aerospace company in Europe. It is active in the fields of civil and military aircraft, helicopters, space, defense systems and services. It designs, develops and produces Ariane launchers.

Safran is one of the world's leading aerospace propulsion companies, with a broad choice of aircraft and rocket engines. It designs and produces commercial engines that are leaders in their thrust classes, while their military engines are world-class performers. In the space sector, Snecma is propulsion prime contractor for Ariane launchers.

The new company, Airbus Safran Launchers, will bring together the expertise of both Airbus Group and Safran in space launchers in order to maintain the level of quality and reliability of Ariane 5 and boost its competitiveness. Airbus Safran Launchers is the prime contractor for Ariane 5 and also the prime contractor for the future European launcher Ariane 6.

1.6.4.2. RUAG Space**RUAG**

RUAG Space is the world's leading supplier of payload fairings for launch vehicles, built in composite technology. Composite technology makes the fairings lightweight yet extremely rigid, essential characteristics for protecting satellites on their journey into space. Besides payload adapters and separation systems, RUAG Space also develops and manufactures satellite structures, mechanisms and mechanical equipment, digital electronics for satellites and launchers, satellite communications equipment and satellite instruments.

To illustrate the industrial experience concentrated behind Ariane 5 prime supplier ASL, the figure 1.6.4.a shows second level subcontractors and their responsibilities.

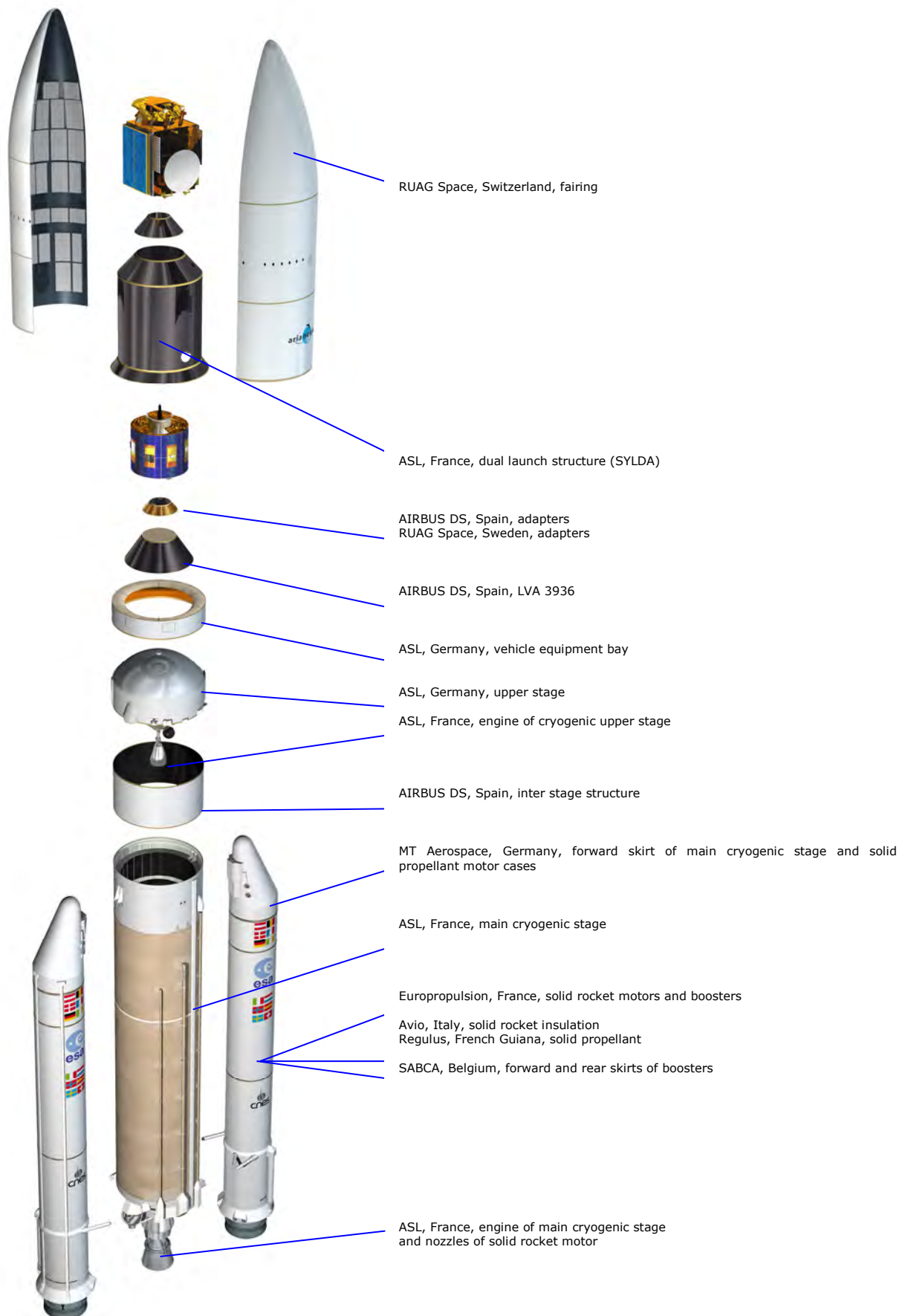

Figure 1.6.4.a – The Ariane main manufacturers

Performance and launch mission

Chapter 2

2.1. Introduction

This section provides the information necessary to make preliminary performance assessments for the Ariane 5 L/V. The following paragraphs present the vehicle reference performance, the typical accuracy, the attitude orientation capabilities and the mission duration.

The provided data cover a wide range of missions from spacecraft delivery to geostationary transfer orbit (GTO), to injection into sun-synchronous and polar orbit, as well as low and high circular or elliptical orbit, and escape trajectories.

Performance data presented in this manual are not fully optimized as they do not take into account the specificity of the customer's mission.

2.2. Performance definition

The performance figures given in this chapter are expressed in term of payload mass.

The mission performance includes the mass of:

- the spacecraft(s)
- the dual launch system (if used), which mass is mission dependant and approximately of:
 - SYLDA 5 (F) 425 kg
 - SYLDA 5 + 300 mm (E) 445 kg
 - SYLDA 5 + 600 mm (D) 460 kg
 - SYLDA 5 + 900 mm (C) 475 kg
 - SYLDA 5 + 1200 mm (B) 490 kg
 - SYLDA 5 + 1500 mm (standard - A) 505 kg
 - SYLDA 5 + 2100 mm (K) 538 kg
- the adapters: adapters masses are defined in the appendices

Performance computations are based on the following main assumptions:

- Aerothermal flux at fairing jettison and second aerothermal flux less or equal to 1135 W/m²,
- Altitude values given with respect to a spherical earth radius of 6378 km,
- Launch from the CSG (French Guiana), taking into account the relevant safety requirements.

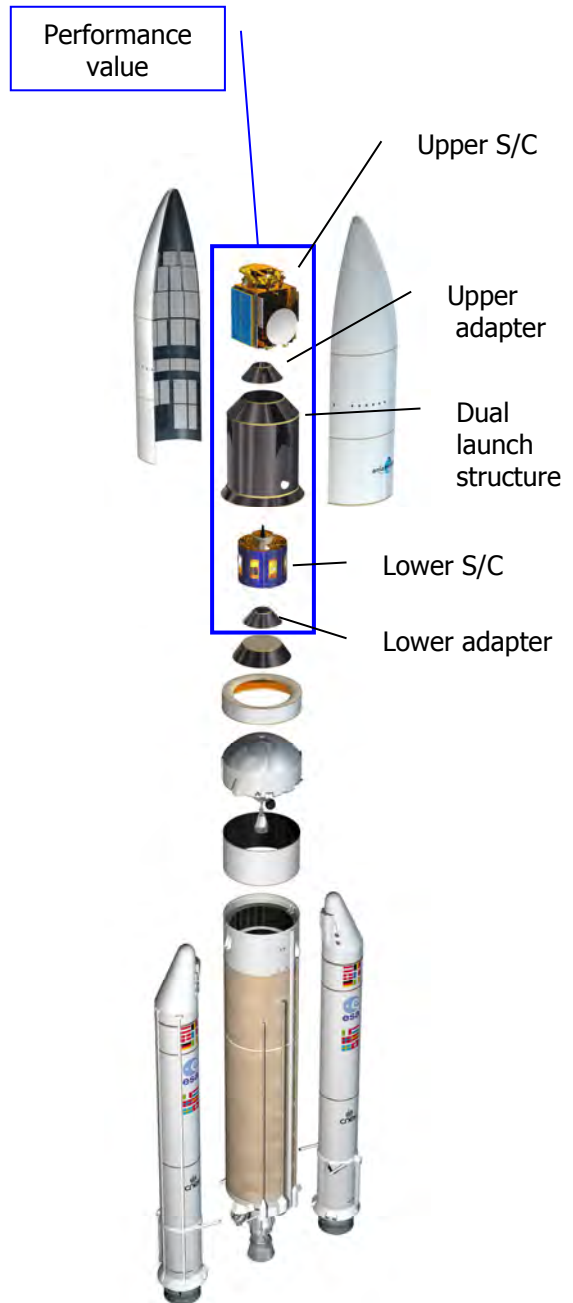

2.3. Typical mission profile

The engine of the cryogenic main core stage, Vulcain 2, is ignited at H0+1s. Until H0+7.05 seconds, the on-board computer checks the good behavior of the engine and authorizes the lift-off by the ignition of the two solid rocket boosters.

The boosters' separation is triggered by an acceleration threshold detection and the fairing is released approximately one minute later when the aerothermal flux becomes lower than the required flux (1135 W/m² is the standard GTO value).

The main stage shutdown occurs when the intermediate target orbit is reached and the separation happens 6 seconds after.

After its separation, the main stage is put in a flat spin mode by opening a lateral venting hole in the hydrogen tank. This control procedure provides a re-entry and a splashdown in the Atlantic Ocean for standard A5ECA GTO missions.

The upper stage ignition occurs a few seconds after main stage separation. The upper stage cut-off command occurs when the guidance algorithm detects the final target orbit. The separation sequence of the spacecraft begins 2 seconds later.

After spacecraft separation, the passivation sequence of the upper stage is realized by:

- the orientation of the stage towards a safe direction with respect to the spacecraft orbits,
- the spinning of the stage up to 45 deg/s for stabilization purpose,
- the outgassing of the tanks through valves.

A typical sequence of events for the GTO mission is presented in figure 2.3.a, together with the ground track and typical evolution of altitude and relative velocity as a function of time.

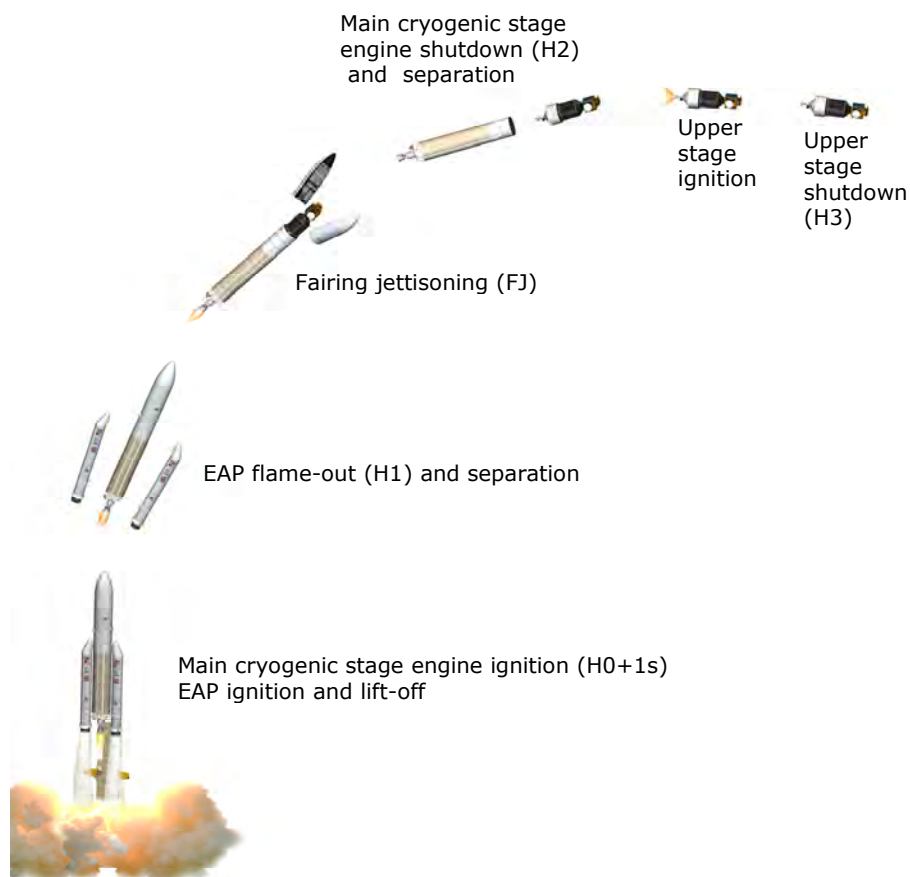

Figure 2.3.a – Ariane 5 typical sequence of events

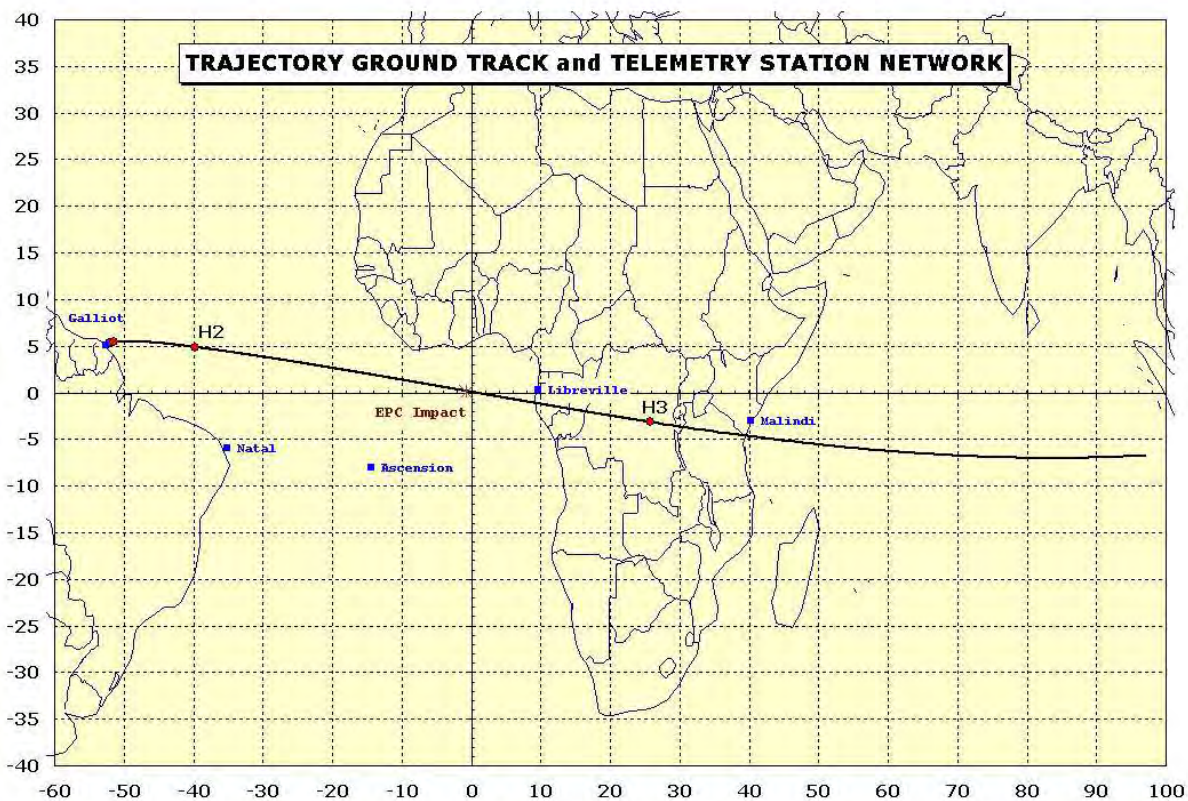

Figure 2.3.b – Ariane 5 typical GTO - Ground track

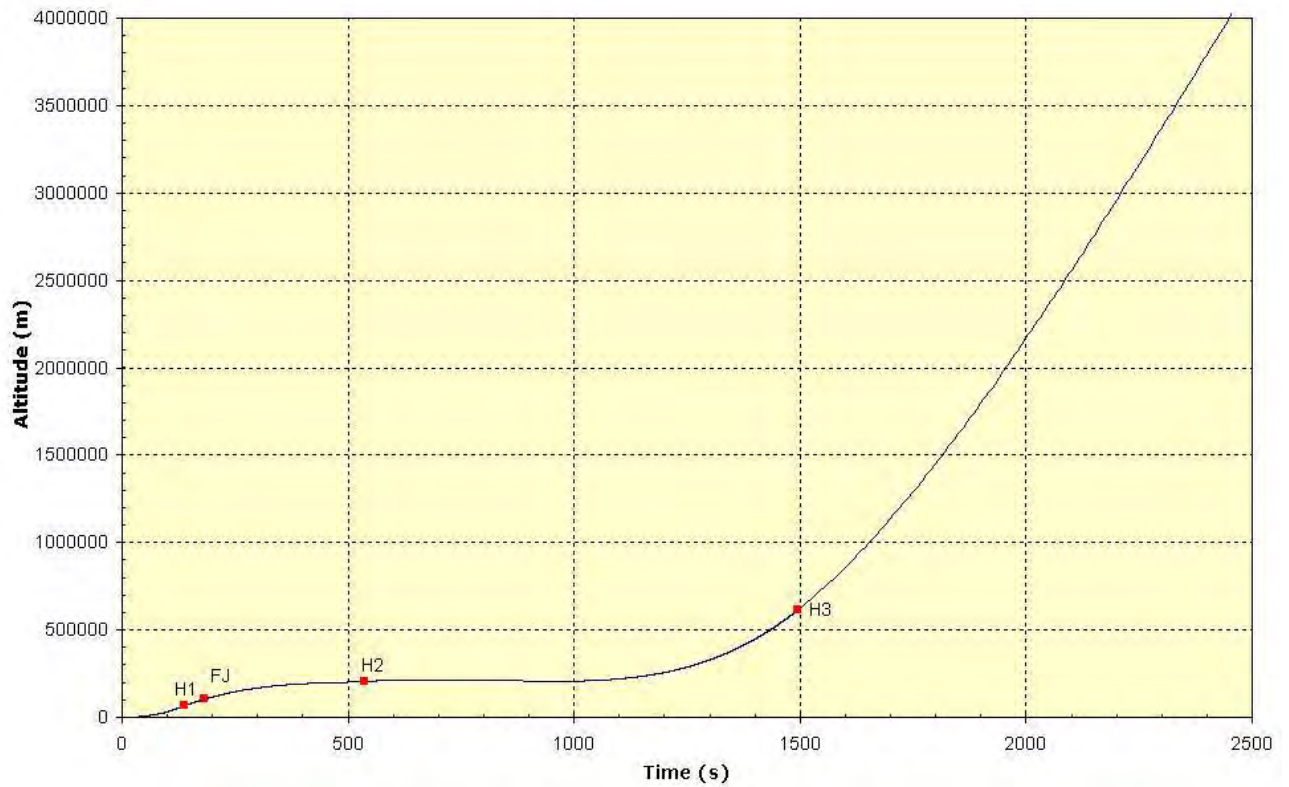

Figure 2.3.c – Ariane 5 typical GTO – Altitude

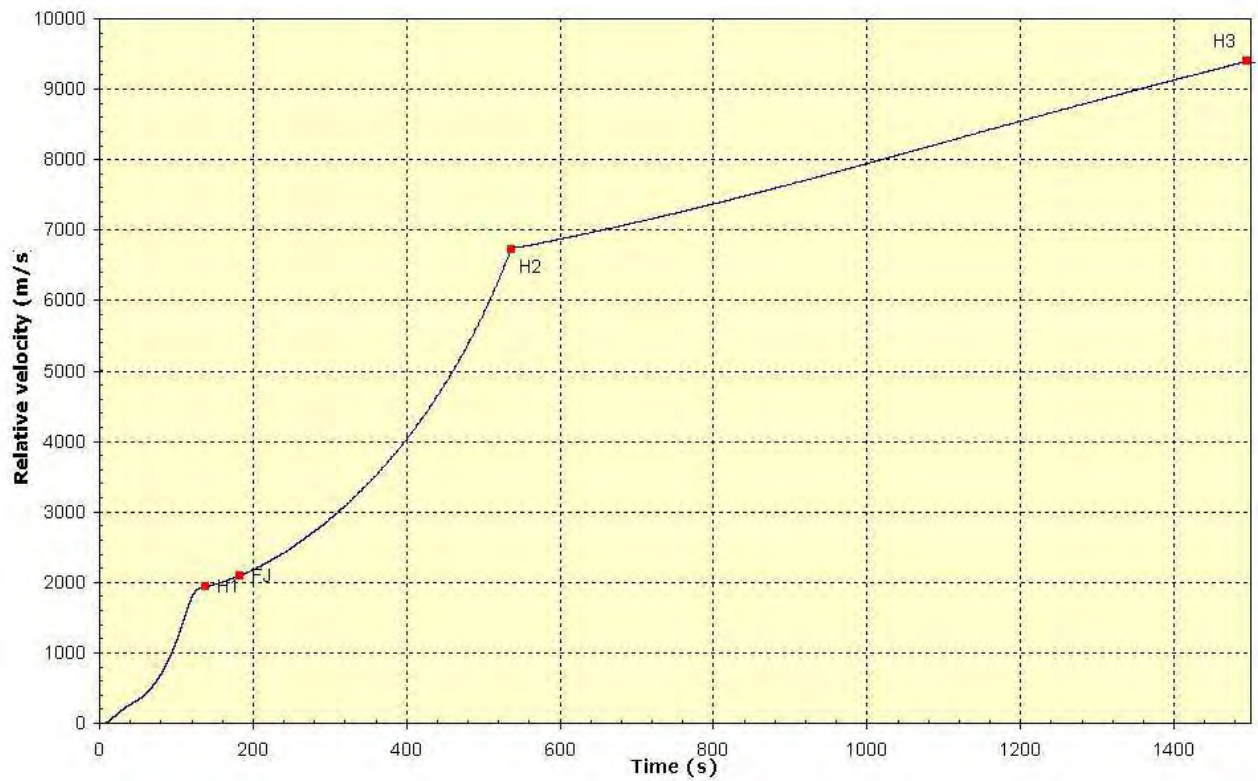

Figure 2.3.d – Ariane 5 typical GTO – Relative velocity

2.4. General performance data

2.4.1. Geosynchronous transfer orbit missions

More than half of the communications satellites in orbit have been launched by Ariane into the Geostationary Transfer Orbit (GTO). These satellites have benefited of the unique location of the Kourou Europe Spaceport: its low latitude minimizes the spacecraft on board propellant needed to reach the equatorial plane. The resulting Ariane 5 shared launch standard Geostationary Transfer Orbit, defined in terms of osculating parameters at injection, is the following:

- Inclination $i = 6$ deg
- Altitude of perigee $Z_p = 250$ km
- Altitude of apogee $Z_a = 35943$ km (*)
- Argument of perigee $\omega_p = 178$ deg

(*) corresponding to 35786 km at first apogee

Injection is defined as the end of the upper stage shutdown.

On a case by case basis, inclination and/or apogee altitude can be tuned in order to determine the optimized joint launch vehicle/spacecraft mission key features.

On a case by case basis, mission with Minimal Residual Shutdown (MRS) of the upper stage can be implemented to provide additional performance to spacecraft.

Please contact Arianespace for more information.

The heavy lift capability of the launcher, associated with the large flexibility of the upper part configurations and Arianespace long demonstrated ability to manage the shared launch policy, enables Ariane 5 to carry any type of spacecraft, from the lightest ones (1000 kg or less) to the tallest and heaviest ones (9500 kg or even more), in shared or single launch, towards the standard GTO.

2.4.2. SSO and polar circular orbits

The launch vehicle performance is higher than 10 tons on an 800 km sun synchronous orbit.

Performance computations are based on the following assumptions:

- aerothermal flux at fairing jettison lower than 500 W/m^2
- launch azimuth of 0° (North)
- inertial node control on a 10 min launch window

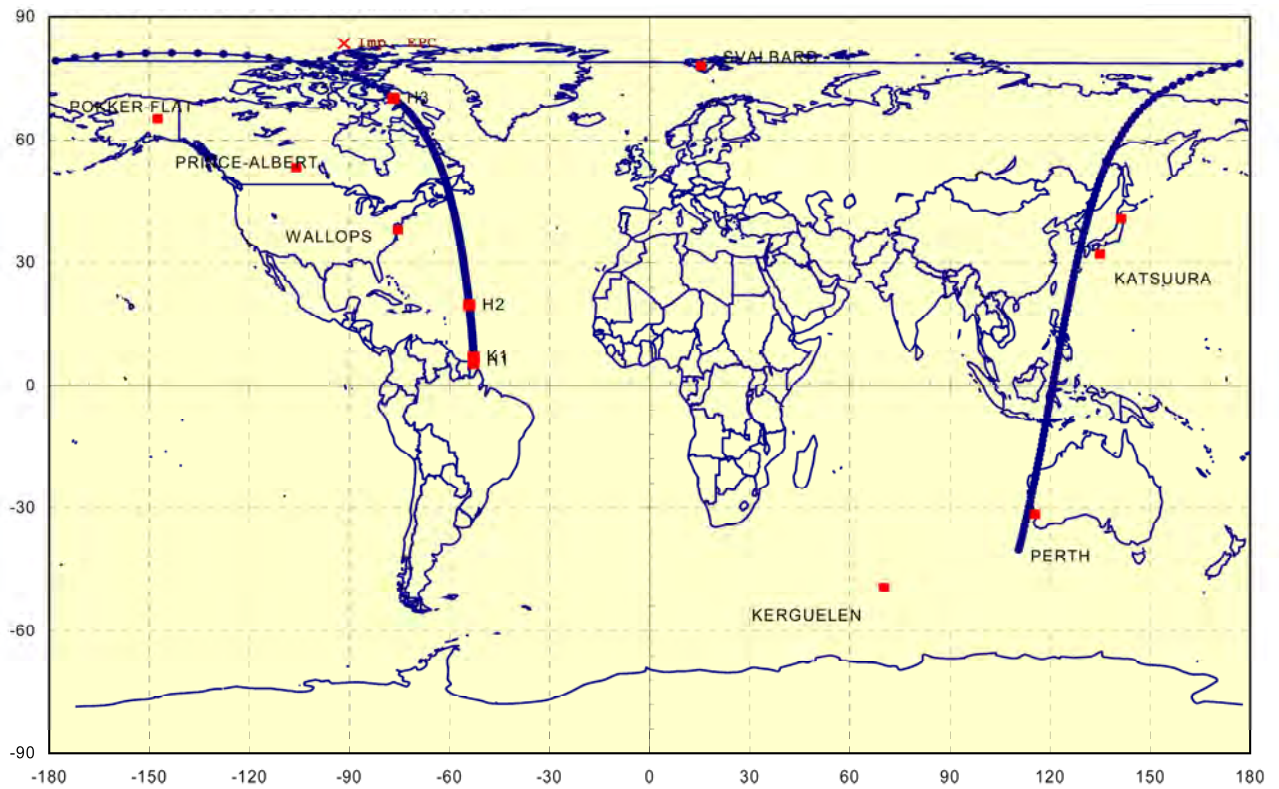

Figure 2.4.2.a – Ariane 5 typical SSO - Ground track

2.4.3. Elliptical orbit missions

Here are some examples of performance estimate with A5ECA for different elliptical missions:

Injection towards the L2 Lagrangian point of the Sun/Earth system:

- apogee altitude 1,300,000 km
- perigee altitude 320 km
- inclination 14 deg
- argument of perigee 208 deg
- performance 6.6 t

Transfer towards zenithal inclined orbit:

- apogee altitude 31,600 km
- perigee altitude 250 km
- inclination 39.5 deg
- argument of perigee 64 deg
- performance 9.2 t

Injection towards the Moon:

- apogee altitude 385,600 km
- perigee altitude 300 km
- inclination 12 deg
- performance 7 t

with the following assumptions:

- aerothermal flux at fairing jettison lower than 1135 W/m²
- launch on time

2.4.4. Earth escape missions

The Ariane 5 ECA version has a performance of 4550 kg towards the following earth escape orbit:

- infinite velocity $V_{\infty} = 3475$ m/s
- declination $\delta = -3.8^{\circ}$

2.4.5. International Space Station orbit

Ariane 5 equipped with a storable propellant upper stage in the ES version can serve the International Space Station with the Automated Transfer Vehicle, on a Low Earth Circular orbit:

- altitude range between 200 and 400 km
- inclination = 51.6 deg

The performance varies between 19 and 21 t, depending on the specific mission.

2.5. Injection accuracy

The following table gives the typical standard deviation (1 sigma) for standard GTO and for SSO.

Standard GTO (6°)

a	semi-major axis (km)	40
e	eccentricity	$4.5 \cdot 10^{-4}$
i	inclination (deg)	0.02
ω_p	argument of perigee (deg)	0.2
Ω	ascending node (deg)	0.2

Leading to:

- standard deviation on apogee altitude 80 km
- standard deviation on perigee altitude 1.3 km

Typical SSO (800 km – 98.6 °)

a	semi-major axis (km)	2.5
e	eccentricity	$3.5 \cdot 10^{-4}$
i	inclination (deg)	0.04
Ω	ascending node (deg)	0.03

2.6. Mission duration

Mission duration from lift-off until separation of the spacecraft on the final orbit depends on the selected mission profile, specified orbital parameters, injection accuracy, and the ground station visibility conditions at spacecraft separation.

Critical mission events such as spacecraft separation are carried out within the visibility of L/V ground stations. This allows for the receipt of near-real-time information on relevant flight events, orbital parameters on-board estimation, and separation conditions.

The typical duration of the GTO mission is between 25 and 35 min, depending on the separation phase events. Actual mission duration will be determined as part of the detailed mission analysis.

2.7. Launch windows

2.7.1. Definitions

- a) **Launch Period**
A period of three consecutive calendar months which will allow the launching of a customer's spacecraft with daily Launch Window possibilities.
- b) **Launch Slot**
One calendar month within a Launch Period.
- c) **Launch Day**
The day of the Launch Slot, during which the Launch Window starts, selected for launching Ariane 5 and its payload with the agreement of the customer(s) and Arianespace.
- d) **Instant of Launch**
Launch vehicle lift-off time, defined in hours, minutes and seconds, within one Launch Window.
- e) **Satellite Injection Window(s) (SIW)**
Daily limited window(s) during which spacecraft injection into the required orbit is achievable.
- f) **Launch Window(s) (LW)**
A Launch Window starts at the beginning of the Satellite Injection Window(s) advanced by the Ariane powered flight time.
Daily LW duration is identical to combined dual launch SIW duration.
- g) **Launch possibility**
The launch possibility starts at the end of the countdown and terminates at the end of the LWs requested by the customer(s). This launch possibility can amount to a maximum of 3 hours.

2.7.2. Process for launch window definition

The spacecraft reference dual launch window will be presented in the DUA and will be agreed upon by the customer and Arianespace at the Preliminary Mission Analysis Review. The calculation will be based on the following reference orbit and time.

Reference time: time of the first passage at orbit perigee in UT hours. This first passage may be fictitious if injection occurs beyond perigee.

Reference orbit (osculating parameters at first perigee):

Apogee altitude	35943 km
Perigee altitude	250 km
Inclination	6 deg
Argument of perigee	178 deg

Longitude of ascending node - 120 deg (with reference to Kourou Meridian at H0-3s).

The final launch window calculation will be based on actual orbit parameters in terms of lift-off time.

The final launch window will be agreed upon by the customer(s) and Arianespace at the Final Mission Analysis Review and no further modification shall be introduced without the agreement of each party.

2.7.3. Launch window for GTO dual launches

The Ariane Authority requires daily common launch windows of at least 45 minutes in order to allow the possibility of a minimum of two launch attempts every day.

In order for this requirement to be met, the spacecraft launch window corresponding to the reference orbit and time defined above must contain at least the window described in figure 2.7.3.a for the launch period of interest. Moreover, it is recommended that the S/C launch window specified by the customer lasts at least 3h.

The physical and mathematical definitions of the minimum window are as follows:

- the daily window is 45 minutes long
- the opening of the window corresponds to a solar aspect angle of 65° with respect to the reference Apogee Motor Firing (AMF) attitude which permits instantaneous transfer from the reference GTO orbit to geosynchronous orbit at apogee 6 (when the line of apsides is colinear with the line of nodes).

Reference AMF attitude:

- right ascension: perpendicular to radius vector at apogee 6
- declination: - 7.45 deg with respect to equatorial plane

2.7.4. Launch window for GTO single launches

The daily launch window will be at least 45 minutes long in one or several parts.

Moreover, it is recommended that the S/C launch window specified by the customer lasts at least 3h.

2.7.5. Launch window for non GTO launches

At customer's request, daily launch windows shorter than 45 minutes may be negotiated after analysis.

2.7.6. Launch postponement

If the launch does not take place inside the Launch Window(s) of the scheduled Launch Day, the launch will be postponed by 24 or 48 hours depending on the situation, it being understood that the reason for postponement has been cleared. Launch time (H0) is set at the start of the new Launch Window and the countdown is restarted.

2.7.7. Engine shutdown before lift-off

In case of launch abort, the new launch attempt will be possible from D0 + 2, at the earliest, and in case of launch vehicle engine change, not before D0 + 10. In that case the launcher will be brought back to the BAF.

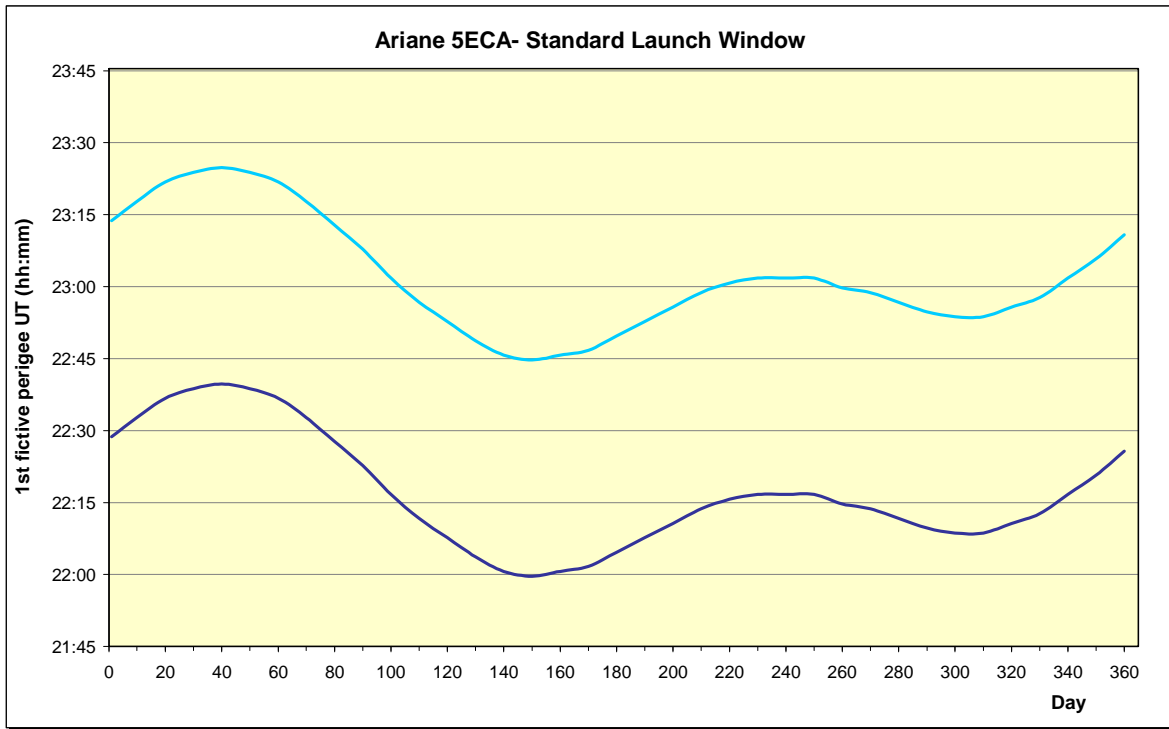

Figure 2.7.3.a - Standard Launch Window at first perigee passage

Day	LW opening	LW closure
1	22:29	23:14
10	22:33	23:18
20	22:37	23:22
30	22:39	23:24
40	22:40	23:25
50	22:39	23:24
60	22:37	23:22
70	22:33	23:18
80	22:28	23:13
90	22:23	23:08
100	22:17	23:02
110	22:12	22:57
120	22:08	22:53
130	22:04	22:49
140	22:01	22:46
150	22:00	22:45
160	22:01	22:46
170	22:02	22:47
180	22:05	22:50
190	22:08	22:53
200	22:11	22:56
210	22:14	22:59
220	22:16	23:01
230	22:17	23:02
240	22:17	23:02
250	22:17	23:02
260	22:15	23:00
270	22:14	22:59
280	22:12	22:57
290	22:10	22:55
300	22:09	22:54
310	22:09	22:54
320	22:11	22:56
330	22:13	22:58
340	22:17	23:02
350	22:21	23:06
360	22:26	23:11

2.8. Spacecraft orientation during the ascent phase

The launch vehicle roll control systems are able to orient the upper composite in order to satisfy a variety of spacecraft position requirements, including requested thermal control maneuvers and sun-angle pointing constraints. The best strategy to meet satellite and launch vehicle constraints will be defined, with the customer, during the mission analysis process.

2.9. Separation conditions

After injection into orbit, the launch vehicle Attitude Control System is able to orient the upper composite to any desired attitude for each spacecraft and to perform separation(s) in various modes:

- 3-axis stabilization
- longitudinal spin
- transverse spin

After completion of the separation(s), the launch vehicle carries out a last maneuver to avoid subsequent collision.

Typical sequences of events are shown in figures 2.9.a (dual launch) and 2.9.b (single launch). Total duration of ballistic sequence is approximately 1200 s (duration is a mission analysis result for each specific mission).

2.9.1. Orientation performance

The attitude at separation can be specified by the customer in any direction in terms of:

- fixed orientation during the entire launch window,
- or
- time variable orientation dependant on the sun position during the launch window.

For other specific S/C pointing, the customer should contact Arianespace.

2.9.2. Separation mode and pointing accuracy

The actual pointing accuracy will result from the Mission Analysis (see para. 7.4.2).

The following values cover Ariane 5 compatible spacecraft as long as their balancing characteristics are in accordance with para. 4.2.3. They are given as S/C kinematic conditions at the end of separation and assume the adapter and separation system are supplied by Arianespace.

In case the adapter is provided by the Spacecraft Authority, the customer should contact Arianespace for launcher kinematic conditions just before separation.

Possible perturbations induced by the spacecraft specificities are not considered in the following values.

2.9.2.1. Three axis stabilized mode

In case the maximum spacecraft static unbalance remains below 30 mm (for a 4500 kg maximum mass spacecraft - see para. 4.2.3.2 for heavier S/C), the typical pointing accuracy is :

- longitudinal geometrical axis de-pointing ≤ 1 deg,
- longitudinal angular tip-off rate ≤ 0.6 deg/s,
- transverse angular tip-off rate ≤ 1 deg/s.

2.9.2.2. Spin stabilized mode

a) Longitudinal spin

The Attitude Control System is able to provide a roll rate about the upper composite longitudinal axis up to 30 deg/s, clockwise or counter clockwise. The Preliminary Mission Analysis (see para. 7.4.2) may show that a higher spin rate could be provided, especially for a single launch. Prediction will be determined for each mission.

b) Transverse spin

A transverse spin can be provided by either asymmetrical separation pushrods (after a 3-axis stabilization of the launcher) or by the Attitude Control System through an upper composite tilting movement (according to spacecraft characteristics).

c) Typical spin mode example

Although the spacecraft kinematic conditions just after separation are highly dependant on the actual spacecraft mass properties (including uncertainties) and the spin rate, the following values are typical results.

In case the maximum spacecraft static unbalance remains below 30 mm and its maximum dynamic unbalance remains below 1 deg (see para. 4.2.3), the typical pointing accuracy for a longitudinal desired spin rate of 30 deg/s is given hereafter:

- spin rate and accuracy = 30 ± 0.6 deg/s,
- transverse angular tip-off rate ≤ 2 deg/s,
- de-pointing of kinetic momentum vector ≤ 6 deg,
- nutation angle ≤ 5 deg.

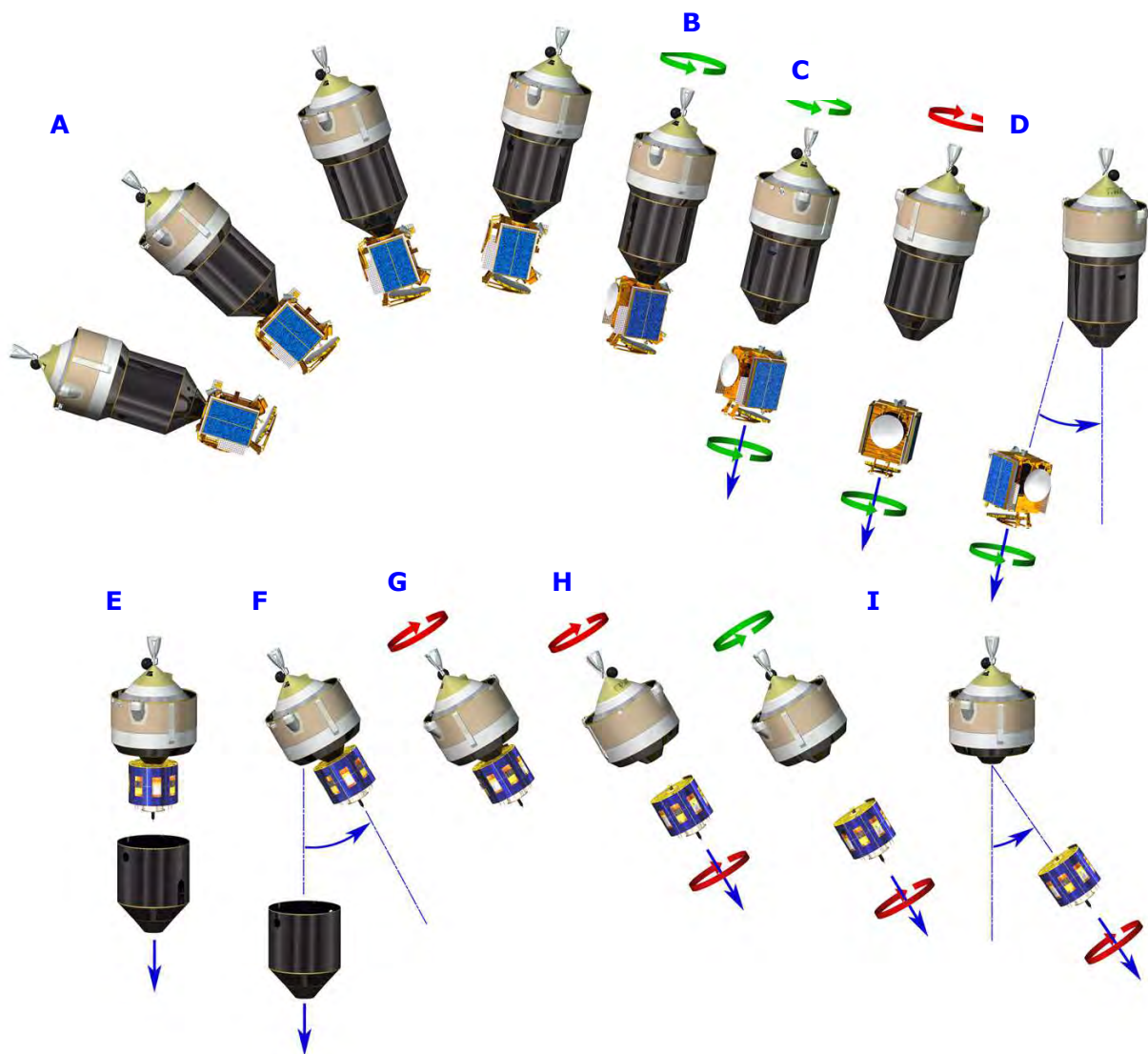

- A Orientation of composite (Upper Stage + VEB + payload) by attitude control system (ACS)
- B Spin-up by ACS
- C Separation of upper spacecraft
- D Spin-down and reorientation to SYLDA 5 jettisoning attitude
- E SYLDA 5 jettisoning
- F Reorientation as requested by lower spacecraft
- G Spin-up by ACS
- H Separation of lower spacecraft
- I Upper stage avoidance maneuver (Spin down, attitude deviation by ACS and passivation)

Note: Spacecraft separations can also be accommodated under a 3-axis stabilized mode

Figure 2.9.a – Typical spacecraft / SYLDA separation sequence

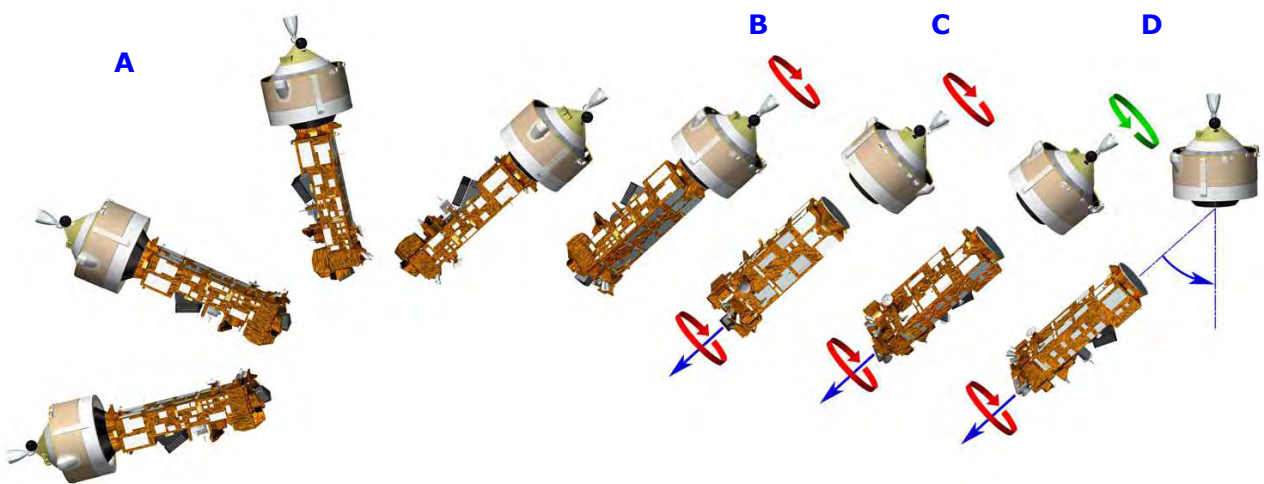

- A Orientation of composite (Upper Stage + VEB + payload) by attitude control system (ACS)
- B Spin-up by ACS
- C Separation of spacecraft
- D Upper stage avoidance maneuver (spin down, attitude deviation by ACS and passivation)

Note: Spacecraft separation can also be accommodated under a 3-axis stabilized mode

Figure 2.9.b – Typical spacecraft separation sequence for single launch

2.9.3. Separation linear velocities and collisions risk avoidance

Each separation system is designed to deliver a minimum relative velocity of 0.5 m/s between the two separated bodies.

For each mission, Arianespace will verify that the distances between orbiting bodies are adequate to avoid any risk of collision until the launcher final maneuver.

For this analysis, the Customer has to provide Arianespace with its orbit and attitude maneuver flight plan, otherwise the spacecraft is assumed to have a pure ballistic trajectory (i.e. no s/c maneuver occurs after separation).

2.9.4. Multi-separation capabilities

Ariane is also able to perform multiple separations with a payload dispenser, or for auxiliary payloads with an ASAP 5 platform.

For more information, please contact Arianespace.

Environmental conditions

Chapter 3

3.1. General

During the preparation for a launch at the CSG and then during the flight, the spacecraft is exposed to a variety of mechanical, thermal, and electromagnetic environments. This chapter provides a description of the environment that the spacecraft is intended to withstand.

All environmental data given in the following paragraphs should be considered as limit loads applying to the spacecraft. The related probability of these figures not being exceeded is 99 %.

Without special notice all environmental data are defined at the spacecraft base, i.e. at the adapter/spacecraft interface.

3.2. Mechanical environment

3.2.1. Static acceleration

3.2.1.1. On ground

The flight static accelerations described hereafter cover the load to which the spacecraft is exposed during ground preparation.

3.2.1.2. In flight

During flight, the spacecraft is subjected to static and dynamic loads. Such excitations may be of aerodynamic origin (e.g. wind, gusts or buffeting at transonic velocity) or due to the propulsion systems (e.g. longitudinal acceleration, thrust buildup or tail-off transients, or structure-propulsion coupling, etc.).

Figure 3.2.1.a shows a typical longitudinal static acceleration-time history for the L/V during its ascent flight. The highest longitudinal acceleration occurs at the end of the solid rocket boost phase and does not exceed 4.55 g.

The highest lateral static acceleration may be up to 0.25 g.

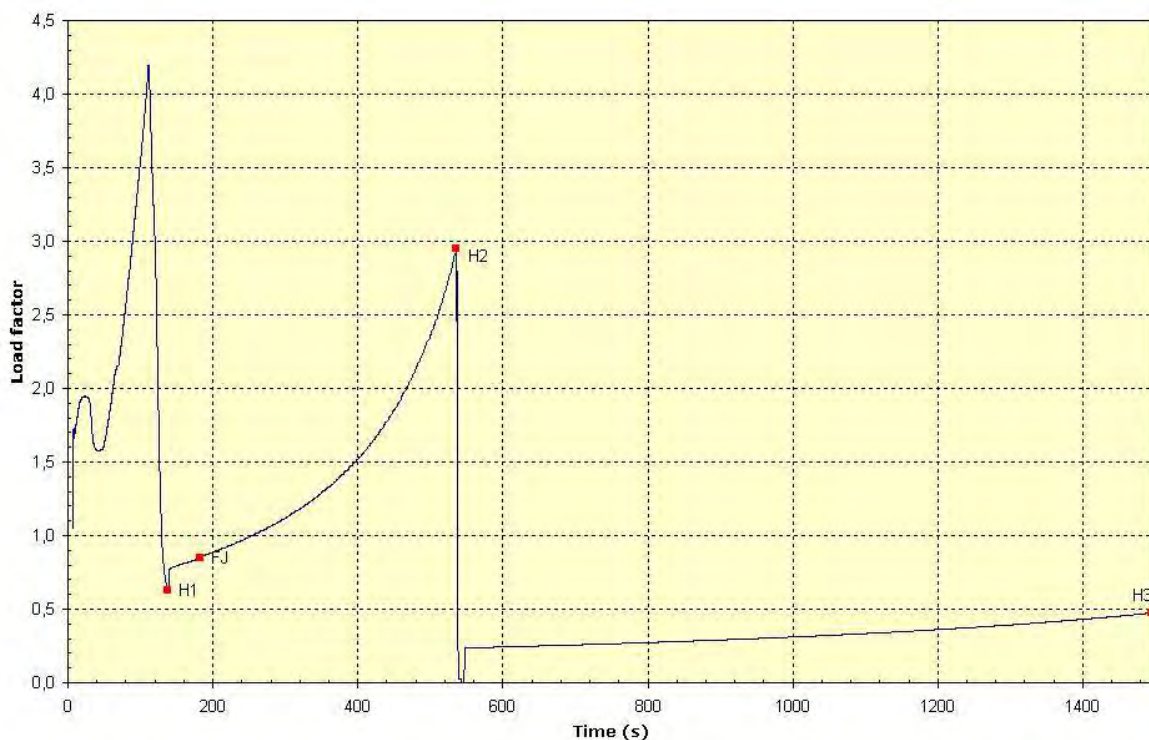

Figure 3.2.1.a – Typical longitudinal static acceleration

3.2.2. Steady state angular motion

For a day launch with a long sun radiation exposure, the launcher could be spun up to 2 deg/s in order to reduce the heat flux on the launcher and on the spacecraft, during boosted and/or coast phases. The performance impact for the propulsive phase shall be evaluated on a case-by-case basis.

3.2.3. Sine-equivalent dynamics

Sinusoidal excitations affect the L/V during its powered flight, mainly the atmospheric flight, as well as during some of the transient phases.

The envelope of the sinusoidal (or sine-equivalent) vibration levels at the spacecraft base does not exceed the values given in table 3.2.3.a.

Direction	Frequency band (Hz)	Sine amplitude (g)
Longitudinal	2 - 50	1.0
	50 - 100	0.8
Lateral	2 - 25	0.8
	25 - 100	0.6

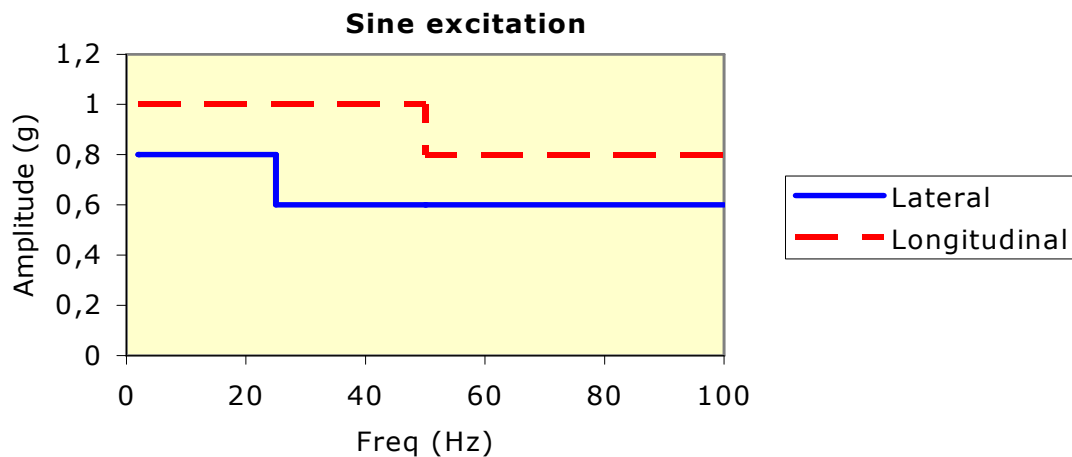

Table 3.2.3.a - Sine excitation at spacecraft base

3.2.4. Random vibration

Under 100 Hz, the random environment is covered by the sine environment defined above in chapter 3.2.3.

The acoustic spectrum defined in chapter 3.2.5 covers excitations produced by random vibration at the spacecraft base for frequency band above 100 Hz.

3.2.5. Acoustic vibration

3.2.5.1. On ground

The noise level generated by the venting system does not exceed 94 dB.

3.2.5.2. In flight

Acoustic pressure fluctuations under the fairing are generated by engine operation (plume impingement on the pad during lift-off) and by unsteady aerodynamic phenomena during atmospheric flight (i.e. shock waves and turbulence inside the boundary layer), which are transmitted through the upper composite structures. Apart from lift-off and transonic phase, acoustic levels are substantially lower than the values indicated hereafter.

The envelope spectrum of the noise induced inside the fairing during flight is shown in table 3.2.5.2.a and figure 3.2.5.2.b. It corresponds to a space-averaged level within the volume allocated to the spacecraft stack, as defined in chapter 5.

It has been assessed that the sound field under the fairing is diffuse.

Octave center frequency (Hz)	Flight limit level (dB) (reference: 0 dB = 2×10^{-5} Pa)
31.5	128
63	131
125	136
250	133
500	129
1000	123
2000	116
OASPL (20 – 2828 Hz)	139.5

Note: OASPL – Overall Acoustic Sound Pressure Level

Table 3.2.5.2.a - Acoustic noise spectrum under the fairing

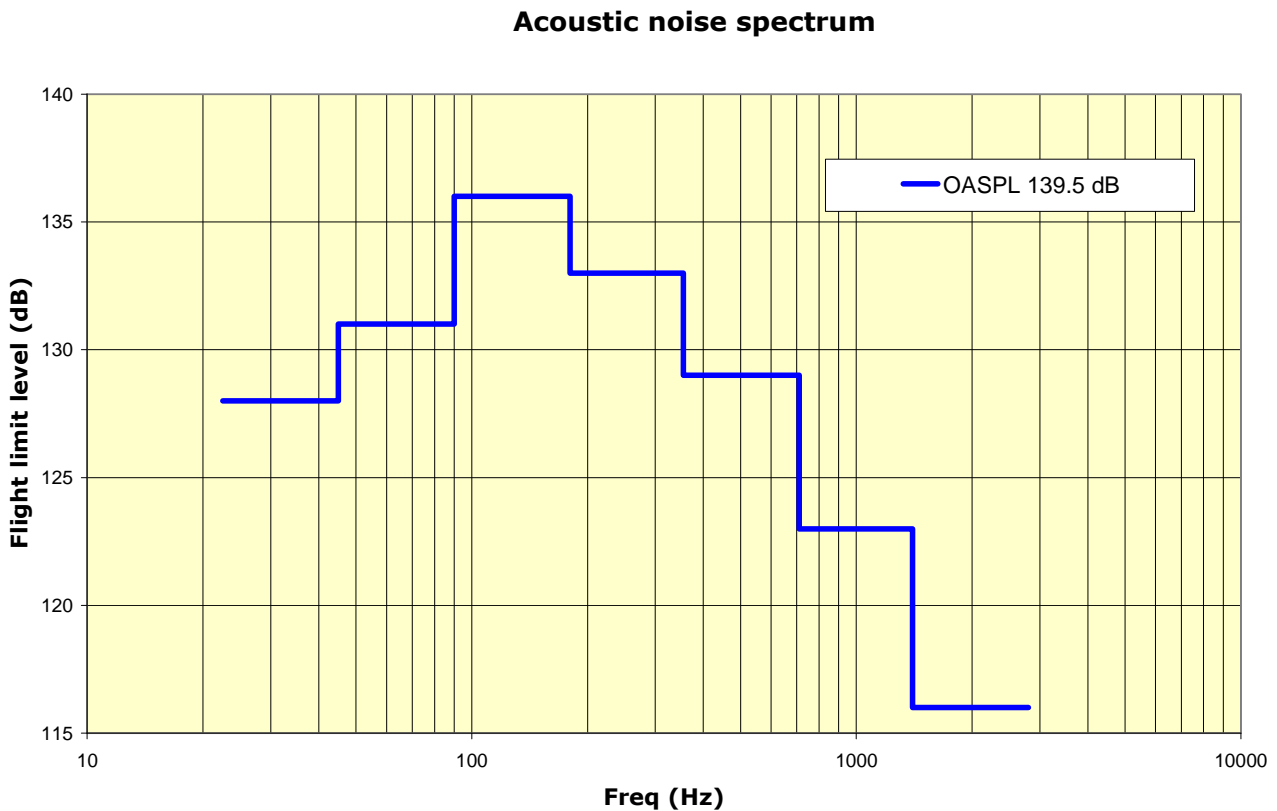

Figure 3.2.5.2.b - Acoustic noise spectrum

3.2.6. Shocks

The spacecraft is subjected to noticeable shocks during the following events:

- the L/V upper stage separation from the main cryogenic stage
- the fairing jettisoning
- the spacecraft separation

The shocks generated by the upper stage separation and the fairing jettison are propagated from their source to the base of the spacecraft through the L/V structures. The envelope of fairing separation shock with the new fairing separation system (HSS3+) and launch vehicle stage separation shocks is below '0.2xfrequency'. Thus the spacecraft separation specification becomes the sizing shock.

The spacecraft separation shock is directly generated at the base of the spacecraft and its levels depend on the adapter type, since the interface diameter and the separation system have a direct impact. For a clampband adapter the envelope of shock response spectrum is given in the below curve.

The way to qualify the spacecraft to launcher shock environment is described in paragraph 4.3.3.4.

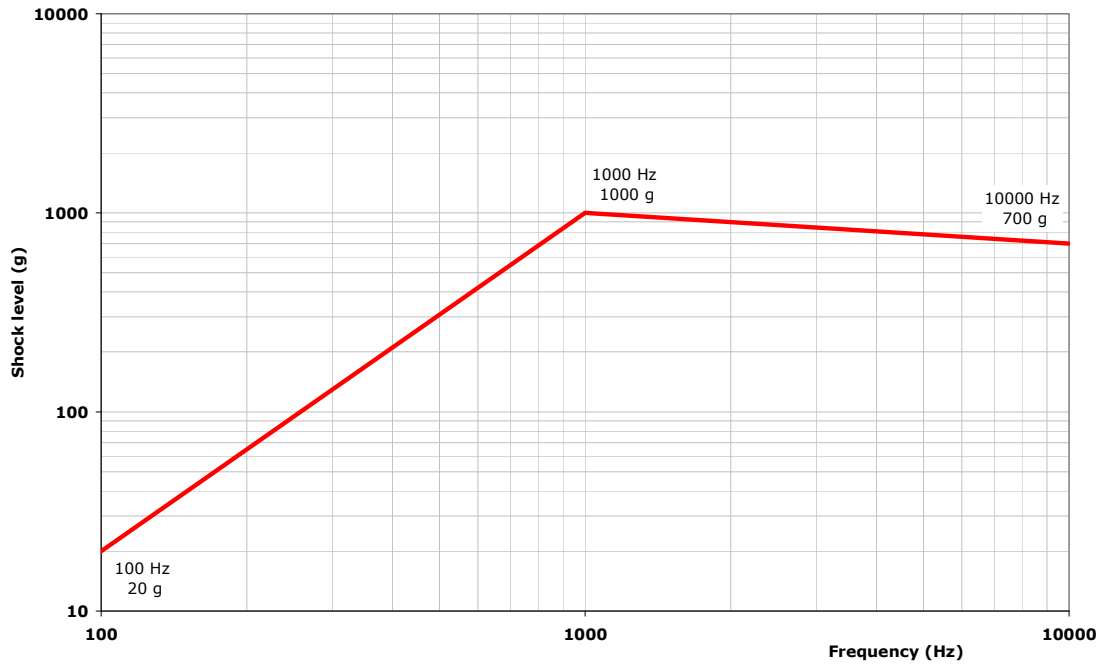

Figure 3.2.6.a Envelope shock spectrum for clampband release at spacecraft interface and for fairing and L/V stage separation events

For customers wishing to use their own adapter, the acceptable levels at the launch vehicle interface are shown in figure 3.2.6.b.

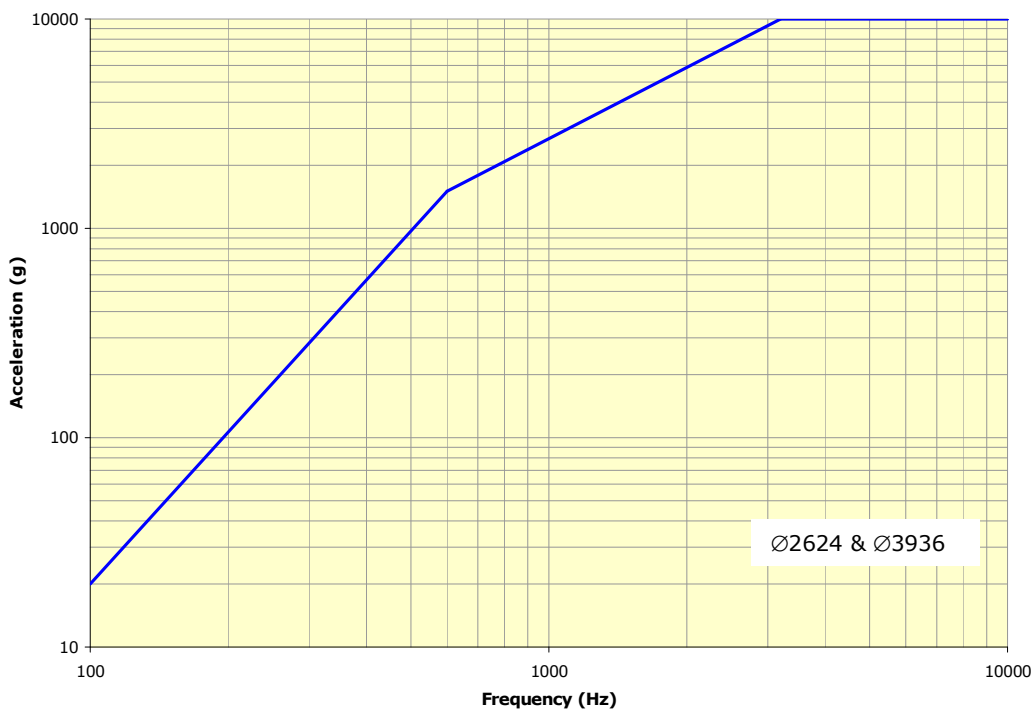

Figure 3.2.6.b – L/V acceptable shock spectrum at launcher bolted interface

3.2.7. Static pressure under the fairing

3.2.7.1. On ground

After encapsulation, the air velocity around the spacecraft due to the ventilation system is lower than 2 m/sec within the fairing and the SYLDA 5 (average value). The velocity may locally exceed this value; contact Arianespace for specific concern.

3.2.7.2. In flight

The payload compartment is vented during the ascent phase through one-way vent doors insuring a low depressurization rate of the fairing compartment.

For spacecraft dimensioning, the following depressurization rate shall be taken into account:

- for most of the time, it does not exceed 2.0 kPa/s (20 mbar/s),
- for a short period of less than 5 seconds (during transonic phase, at ~50s), it can reach 4.5 kPa/s (45 mbar/s).

The typical static pressure evolution under the fairing is shown in figure 3.2.7.2.a. This graph is provided for information only and should not be taken for spacecraft dimensioning.

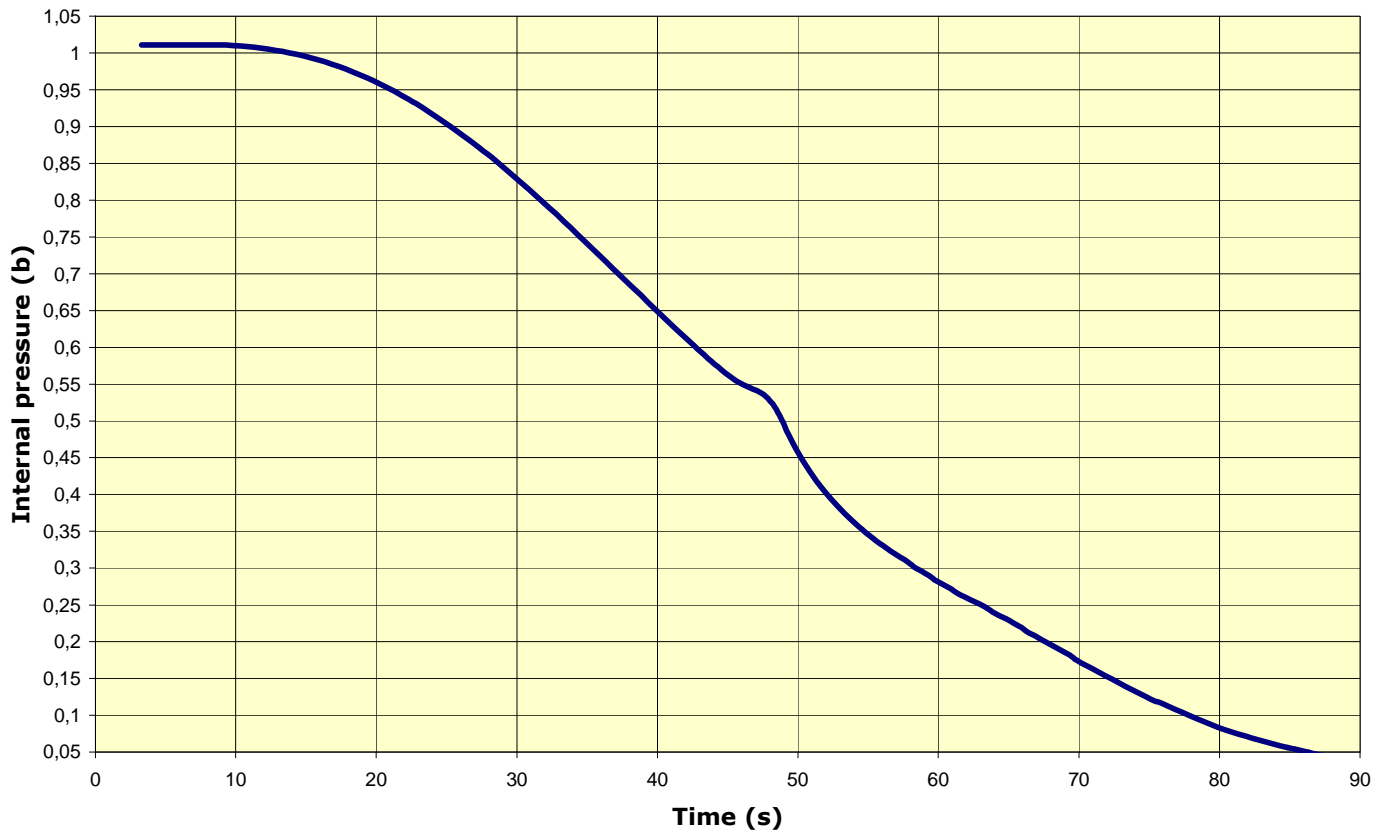

Figure 3.2.7.2.a – Variation of static pressure within payload volume

3.3. Thermal environment

3.3.1. Introduction

The thermal environment provided during spacecraft preparation and launch has to be considered during the following phases:

- Ground operations:
 - The spacecraft preparation within the CSG facilities;
 - The upper composite and launch vehicle operations with spacecraft encapsulated inside the fairing or the SYLDA 5.
- Flight:
 - Before fairing jettisoning;
 - After fairing jettisoning.

3.3.2. Ground operations

The environment that the spacecraft experiences both during its preparation and once it is encapsulated, is controlled in terms of temperature, relative humidity, cleanliness, and contamination.

3.3.2.1. CSG facility environments

The typical thermal environment within the air-conditioned CSG facilities is kept around $23^{\circ}\text{C} \pm 2^{\circ}\text{C}$ for temperature and $55\% \pm 5\%$ for relative humidity.

More detailed values for each specific hall and buildings are presented in the EPCU User's Manual and in chapter 6.

3.3.2.2. Thermal conditions under the fairing or the SYLDA 5

During the encapsulation phase and once mated to the launch vehicle, the spacecraft is protected by an air-conditioning system provided by ventilation through the pneumatic umbilicals (see figure 3.3.2.2.b for characteristics of air-conditioning).

S/C location	Transfer between buildings	S/C in EPCU and BAF/HE	S/C on L/V			
	In CCU 2 and CCU 3 container	Not encapsulated and Encapsulated (upper S/C)	In BAF / upper platforms		Transfer to launch zone ** (duration 3h)	On launch pad
			Not Encapsulated (lower S/C)	Encapsulated		
Hygrometry level	≤ 60%	40% - 60%	40% - 60%	≤ 20% (flushing by dry air)	< 70% (flushing by air cond)	≤ 20% (flushing by dry air)
Temperature	24 ± 3°C	23 ± 2°C*	24 ± 2°C	11°C min***	11°C min***	11°C min***

For information, in the EPCU buildings $998 \text{ mbar} \leq P_{\text{atm}} \leq 1023 \text{ mbar}$

* For optional temperature setting configurations in EPCU high-bays, refer to EPCU User's Manual.

** During transfer phase of Launcher to the Launch Zone, Dew Point is 6.5°C. Since the lowest achievable temperature of the air flow blown inside the satellite compartment is 11°C, there is no risk of condensation on the satellite during this phase.

*** This temperature is measured at fairing interface.

Table 3.3.2.2.a – Thermal environment on ground

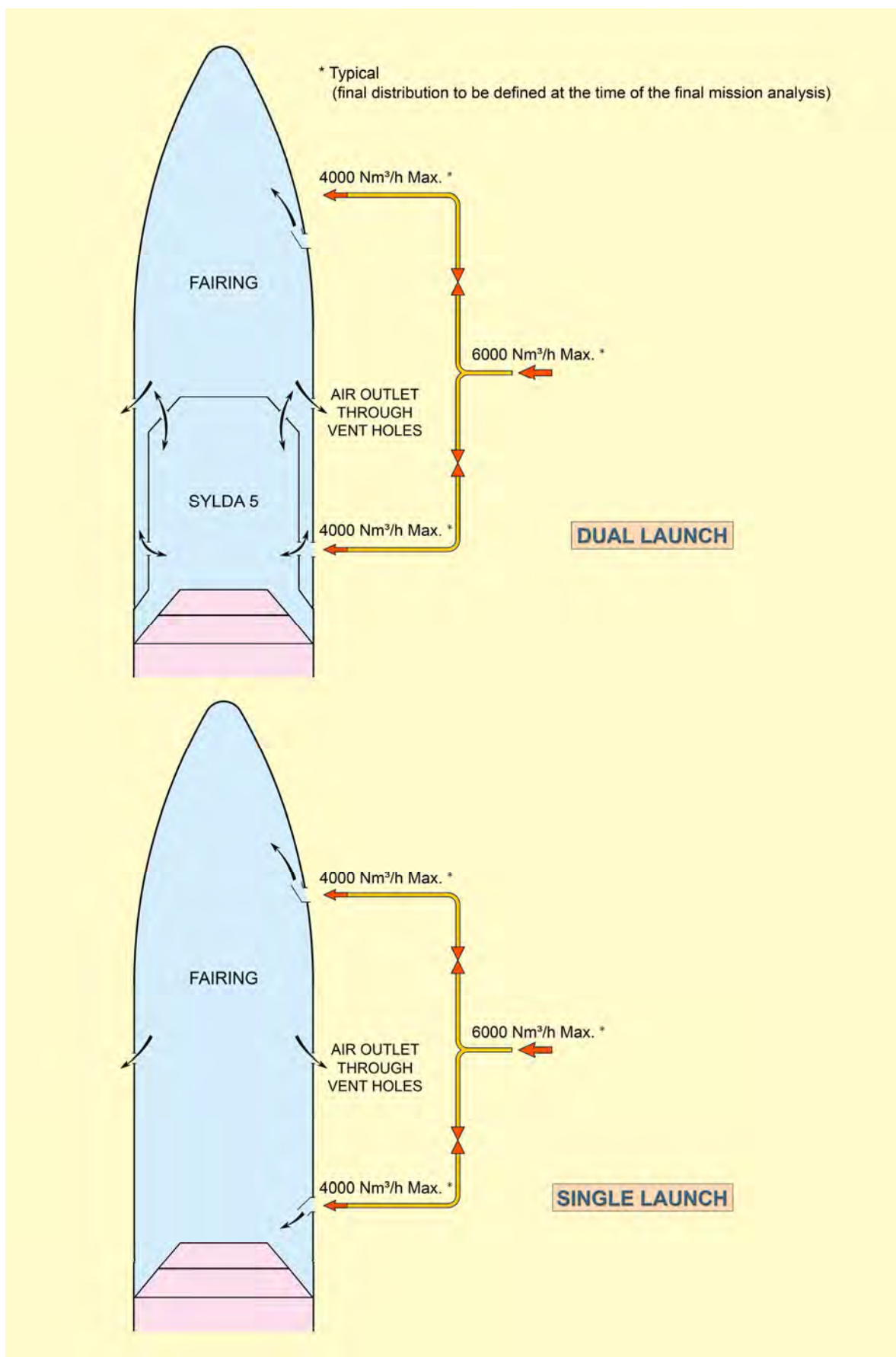

Figure 3.3.2.2.b- Configuration of ventilation within spacecraft volumes

3.3.3. Flight environment

3.3.3.1. Thermal conditions before fairing jettisoning

The net flux density radiated by the fairing or the SYLDA 5 does not exceed 1000 W/m^2 at any point.

This figure does not take into account any effect induced by the spacecraft dissipated power.

3.3.3.2. Aerothermal flux and thermal conditions after fairing jettisoning

This is not applicable to any passenger inside the SYLDA 5.

The nominal time for jettisoning the fairing is determined in order to not exceed the aerothermal flux of 1135 W/m^2 . This flux is calculated as a free molecular flow acting on a plane surface perpendicular to the velocity direction, and based on the atmospheric model US66, latitude 15° North.

For the standard GTO mission, the sizing free molecular heating profile is presented on figure 3.3.3.2.a.

For dedicated launches (or multiple launches if agreed by passengers) lower or higher flux exposures can be accommodated on request, as long as the necessary performance is maintained.

Solar-radiation flux, albedo and terrestrial infrared radiation and conductive exchange with L/V must be added to this aerothermal flux. While calculating the incident flux on the spacecraft, account must be taken of the altitude of the launch vehicle, its orientation, the position of the sun with respect to the launch vehicle, and the orientation of the considered spacecraft surfaces.

During daylight with long ballistic and/or boosted phases, the sun radiation has to be taken into account. In order to reduce the heat flux, the launcher can be spun up to a maximum of 2 deg/s . The performance impact has to be assessed.

A specific attitude with respect to the sun may also be used to reduce the heating, during boosted and/or coast phases. This will be studied on a case by case basis.

3.3.3.3. Other fluxes

No other thermal fluxes need to be considered.

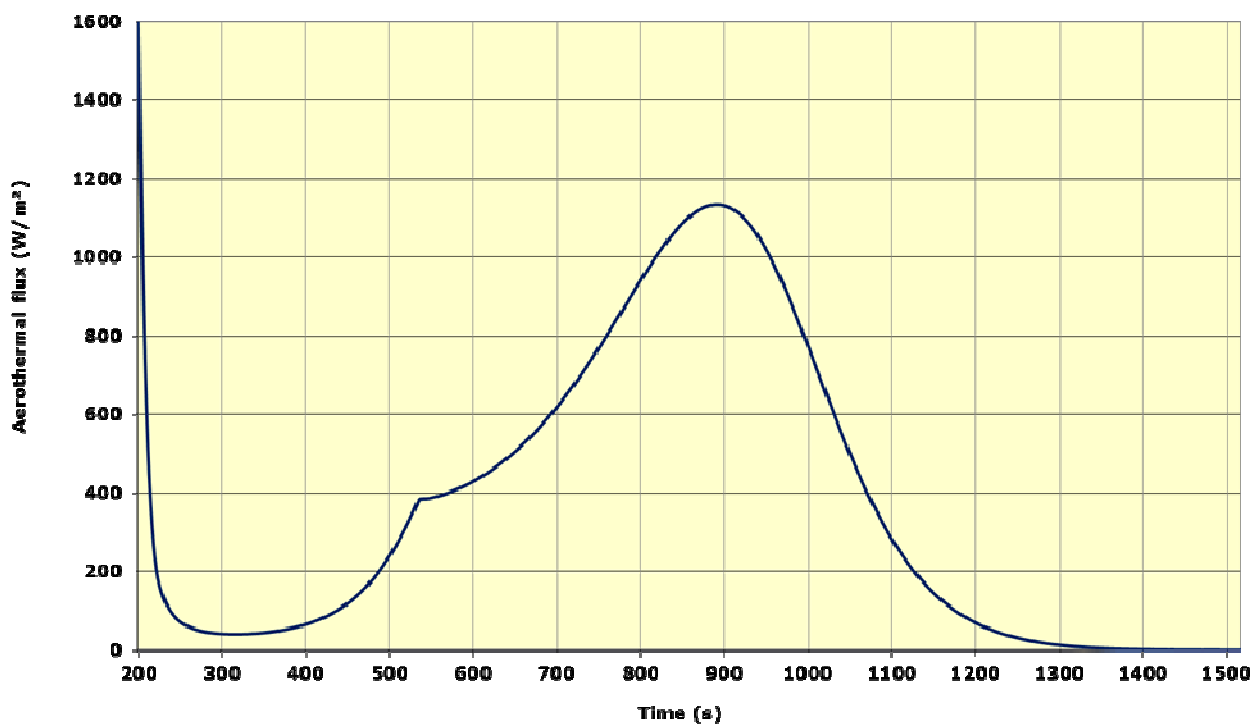

**Figure 3.3.3.2.a – Aerothermal fluxes on trajectory
Ariane 5 equipped with cryogenic upper stage (ESC-A)
Fairing jettisoning constrained at 1135 W/m^2**

3.4. Cleanliness and contamination

3.4.1. Cleanliness level in environment

The following standard practices ensure that spacecraft cleanliness conditions are met:

- A clean environment is provided during production, test and delivery of all upper-composite components (fairing, adapters, SYLDA 5) to prevent contamination and accumulation of dust. The L/V materials are selected not to generate significant organic deposit during all ground phases of the launch preparation.
- All spacecraft operations are carried out in EPCU buildings (PPF, HPF and BAF) in controlled class 100,000 / ISO 8 clean rooms. During transfer between buildings the spacecraft is transported in payload containers (CCU) with the cleanliness class 100,000/ ISO 8. All handling equipment is clean room compatible, and it is cleaned and inspected before its entry in the facilities.
- Once encapsulated and during transfer and standby on the launch pad, the upper composite is hermetically closed and a class 10,000 / ISO 7 air-conditioning of the fairing and the SYLDA 5 is provided.

S/C location	Transfer between buildings	S/C in EPCU and BAF/HE		S/C on L/V			
	In CCU container	Not encapsulated	Encapsulated (upper S/C)*	In BAF / PFCU		Transfer to launch zone* (duration 3h)	On launch pad*
				Not encapsulated	Encapsulated *		
Cleanliness class	100,000 / ISO 8	100,000 / ISO 8	10,000 / ISO 7	100,000 / ISO 8	10,000 / ISO 7	10,000 / ISO 7	10,000 / ISO 7

* Filtration of air-conditioning systems: standard HEPA H14 (DOP 0.3 µm)

Table 3.4.1.a – Cleanliness during ground operations

3.4.2. Deposited Contamination

The organic and particule contaminations in facilities and under the fairing are controlled by contamination witness plates set up inside the buildings and inside the fairing from encapsulation until D-2. The L/V systems are designed to preclude in-flight contamination of the spacecraft. The pyrotechnic devices used by the L/V for fairing jettison and SYLDA 5, spacecraft separations are leak proof and do not lead to any spacecraft contamination.

3.4.2.1. Particule contamination

- **Deposited particle contamination in the clean rooms**

In accordance with ECSS-Q-70-01A, the ISO 8 cleanliness level is equivalent to a deposited particle contamination of 1925 ppm/week. However, Arianespace standard practice is to consider a deposited particle contamination of 1,000 ppm/week in the clean rooms and the surrounding environment of a satellite.

- **Deposited particle contamination on launcher items**

Launcher equipments in the vicinity of a satellite will be cleaned in case the deposited particles contamination exceeds 4 000 ppm.

Prior to the encapsulation of the spacecraft, the cleanliness of the SYLDA 5 and the fairing could be verified based on the Visibly Clean Level 2 criteria, and cleaned if necessary.

3.4.2.2. Organic contamination

- **Deposited Organic contamination in the clean rooms**

The clean rooms and the surrounding environment of a satellite shall not generate deposited organic contamination exceeding 0.5 mg/m²/week.

- **Deposited organic contamination on launcher items**

Launcher equipments in the vicinity of a satellite will be cleaned in case deposited organic contamination exceeds 2 mg/m².

- **Deposited organic contamination from encapsulation to S/C separation**

The maximum organic non-volatile deposit on satellite surfaces is lower than 4 mg/m² from encapsulation and until 4h00 after satellite separation, taking into account a maximum of 2 mg/m² due to out-gassing launcher materials and 2 mg/m² due to inter-stage separation system

The non-volatile organic contamination generated during ground operations and in flight is cumulative.

3.5. Electromagnetic environment

The L/V and launch range RF systems and electronic equipments are generating electromagnetic fields that may interfere with spacecraft equipment and RF systems. The electromagnetic environment depends on the characteristics of the emitters and the configuration of their antennae.

3.5.1. L/V and range RF systems

Launcher

The launch vehicle is equipped with the following transmission and reception systems:

- a telemetry system comprising two transmitters, each one coupled with one left-handed antenna having an omnidirectional radiation pattern. Both transmitters are located in the VEB with their antennae fitted in the external section of the VEB. The transmission frequency is in the 2200 – 2290 MHz band, and the transmitter power is 8 W. Allocated frequencies to the launch vehicle are 2206.5 MHz, 2227 MHz, 2254.5 MHz, 2267.5 MHz and 2284 MHz.
- a telecommand-destruct reception system, comprising two receivers operating in the 440 – 460 MHz band. Each receiver is coupled with a system of two antennae, located on the cryogenic core stage, having an omnidirectional pattern and no special polarization.
- a radar transponder system, comprising two identical transponders with a reception frequency of 5690 MHz and transmission frequencies in the 5400 – 5900 MHz band. The minimum pulsed (0.8 μ s) transmitting power of each transponder is 400 W peak. Each transponder is coupled with a system of two antennae, located on the cryogenic core stage, with an omnidirectional pattern and clockwise circular polarization.

Range

The ground radars, local communication network and other RF mean generate an electromagnetic environment at the preparation facilities and launch pad, and together with L/V emission constitute an integrated electromagnetic environment applied to the spacecraft. The EM data are based on the periodical EM site survey conducted at CSG.

3.5.2. The electromagnetic field

The intensity of the electrical field generated by spurious or intentional emissions from the launch vehicle and the range RF systems do not exceed those given in figure 3.5.2.a. Actual levels will be the same or lower taking into account the attenuation effects due to the adapter/dispenser configuration, or due to worst case assumptions taken into account in the computation.

Actual spacecraft compatibility with these emissions will be assessed during the preliminary and final EMC analysis.

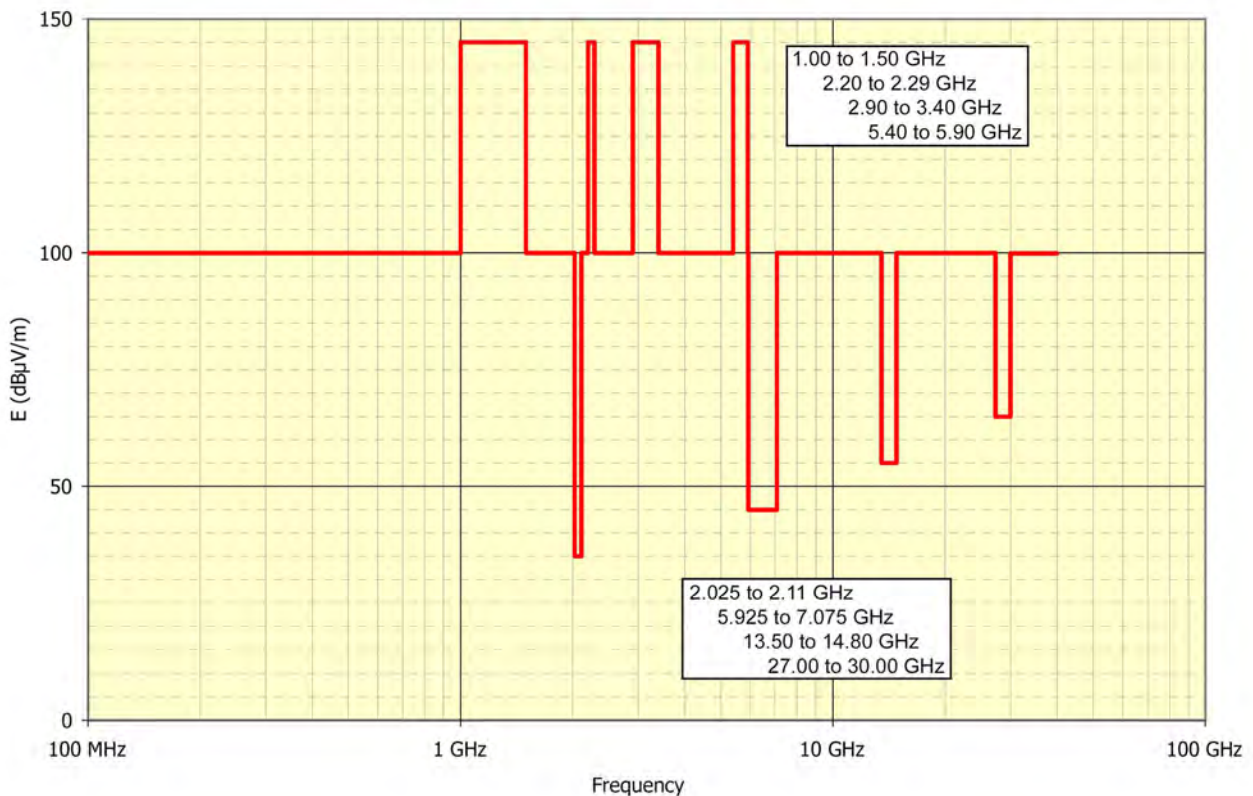

Figure 3.5.2.a – Spurious radiation and intentional emissions by launch vehicle and launch base - Narrow-band electrical field 1.0m below the separation plane (free space)

To avoid potential concern with the co passenger in case of dual launch, it is recommended, outside the S/C receivers frequencies bands, to demonstrate a S/C susceptibility greater or equal to 150 dBµV/m from 1.0 to 40 GHz.

3.6. Environment verification

To confirm that the environment during the flight complies with the prediction and to ensure that Interface Control Document requirements are met, a synthesis of the instrumentation record of the upper composite is provided.

The Ariane 5 telemetry system captures low and high frequency data during the flight from the sensors installed on the fairing, the SYLDA 5, the VEB, the upper stage and the adapters, and then relays these data to the ground stations. These measurements are recorded and then processed during the post-flight analyses.

Should a customer provide the adapter, Arianespace will supply the customer with transducers to be installed on the adapter close to the interface plane if needed.

Spacecraft design and verification requirements

Chapter 4

4.1. Introduction

The design and dimensioning data that shall be taken into account by any customer intending to launch a spacecraft compatible with the Ariane 5 launch vehicle are detailed in this chapter.

4.2. Design requirements

4.2.1. Safety Requirements

The customer is required to design the spacecraft in conformity with the Payload Safety Handbook.

4.2.2. Selection of spacecraft materials

The spacecraft materials must satisfy the following outgassing criteria:

- Recoverable Mass Loss (RML) ≤ 1 %;
- Collected Volatile Condensable Material (CVCM) ≤ 0.1 %.

Measured in accordance with the procedure ECSS-Q-70-02A.

4.2.3. Spacecraft properties

4.2.3.1. Spacecraft mass and CoG limits

Off-the-shelf adapters provide accommodation for a wide range of spacecraft masses and centers of gravity. See annexes referring to adapters for detailed values.

For spacecraft with characteristics outside these domains, please contact Arianespace.

4.2.3.2. Static unbalance

a) Spun-up spacecraft

The center of gravity of the spacecraft must stay within a distance $d \leq 30$ mm from the launcher longitudinal axis.

b) Three-axis stabilized spacecraft

The acceptable static unbalance limit varies with the spacecraft mass as follows:

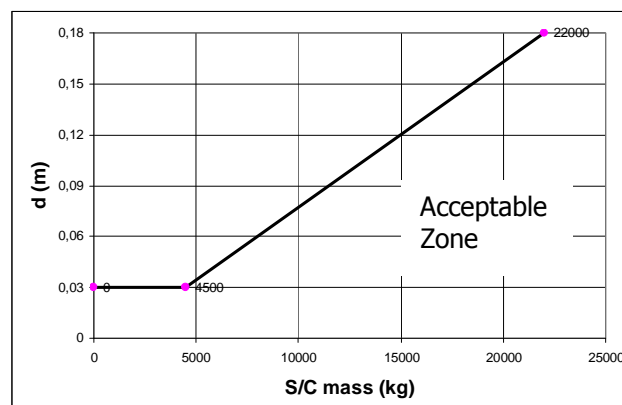

4.2.3.3. Dynamic unbalance

There is no predefined requirement for spacecraft dynamic balancing with respect to ensuring proper operation of the L/V. However, these data have a direct effect on spacecraft separation.

To ensure the separation conditions in spin-up mode described in the chapter 2, the maximum spacecraft dynamic unbalance ε , corresponding to the angle between the spacecraft longitudinal geometrical axis and the principal roll inertia axis, shall be $\varepsilon \leq 1$ degree.

For S/C with spin velocity $< 6^\circ/\text{s}$, there is no dynamic unbalance specification as for the three-axis stabilized S/C.

4.2.3.4. Frequency Requirements

To prevent dynamic coupling between the low-frequency launch vehicle and spacecraft modes and to be compatible with the launcher piloting capacity domain, the spacecraft should be designed with a structural stiffness which ensures that the following requirements are fulfilled. In that case the design limit load factors given in next paragraph are applicable.

Lateral frequencies

The fundamental (primary) frequency in the lateral axis of a spacecraft cantilevered at the interface must be as follows (provided that an off the self adapter will be used for flight):

In double launch configuration

S/C mass (kg)	CoG height / separation plane (m)	1st fundamental lateral frequency (Hz)	Transverse inertia / separation plane Or / plan Ø2624 (kg.m ²)
$M \leq 4500$	≤ 1.9	≥ 10	$\leq 30,000$ / separation plane Or $\leq 50,000$ / plane Ø2624
$4500 < M \leq 6500$	≤ 2.6	≥ 8	$\leq 55,000$ / separation plane Or $\leq 90,000$ / plane Ø2624

For spacecraft mass above 6.5T please contact Arianespace.

In single launch configuration, please contact Arianespace.

No secondary mode should be lower than the first primary mode.

Longitudinal frequencies

The fundamental frequency in the longitudinal axis of a spacecraft cantilevered at the interface must be as follows (provided that an off-the-self adapter will be used for flight):

- ≥ 31 Hz for S/C mass < 4500 kg
- ≥ 27 Hz for S/C mass ≥ 4500 kg

No secondary mode should be lower than the first primary mode.

Nota on Definition of primary and secondary modes:

Primary Modes: modes associated with large effective masses (in practice there are 1 or 2 primary modes in each direction)

Secondary mode: the mode that is not primary i.e. with small effective mass.

4.2.4. Dimensioning Loads

4.2.4.1. The design load factors

The design and dimensioning of the spacecraft primary structure and/or evaluation of compatibility of existing spacecraft with Ariane 5 launch vehicle shall be based on the design load factors.

The design load factors are represented by the Quasi-Static Loads (QSL) that are the more severe combinations of dynamic and static accelerations that can be encountered at any instant of the mission (ground and flight operations).

The QSL reflect the line loads at the interface between the spacecraft and the adapter.

The flight limit levels of QSL for a spacecraft launched on Ariane 5 and complying with the previously described frequency requirements and with the static moment limitation are given in the table 4.2.4.1.a.

Acceleration (g)	Longitudinal		Lateral	Additional line load (N/mm)
	Static	Dynamic	Static + Dynamic	
Critical flight events				
Lift-off	- 1.8	± 1.5	± 2	26
Aerodynamic phase	- 2.7	± 0.5	± 2	23
Pressure oscillations / SRB end of flight	- 4.40	± 1.6	± 1	37
SRB jettisoning *	-0.7	± 3.2	± 0.9	0

* This flight phase leads to a 2.5 g tension case, except for a spacecraft with first longitudinal frequency above 40 Hz where the tension value is the following:

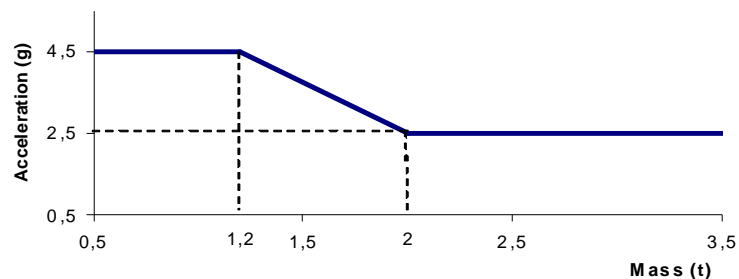

*The minus sign with longitudinal axis values indicates compression.
Lateral loads may act in any direction simultaneously with longitudinal loads.
The Quasi-Static Loads (QSL) apply on payload CoG.
The gravity load is included.*

Table 4.2.4.1.a – Quasi-Static Loads – Flight limit levels

4.2.4.2. Line loads peaking

The geometrical discontinuities and differences in the local stiffness of the L/V (stiffeners, holes,...) and the non-uniform transmission of the L/V's thrust at the spacecraft/adapter interface may produce local variations of the uniform line loads distribution.

Line loads peaking induced by the Launch Vehicle:

The integral of these variations along the circumference is zero, and the line loads derived from the QSL are not affected, but for the correct dimensioning of the lower part of the spacecraft this excess shall be taken into account, and has to be added uniformly at the S/C adapter interface to L/V mechanical line loads obtained for the various flight events.

The value for each flight event is defined in above table 4.2.4.1.a, disregarding any spacecraft discontinuity.

These values are applicable for upper and lower spacecraft position with any type of adapter.

Line loads peaking induced by spacecraft:

The maximum value of the peaking line load induced by the spacecraft is allowed in local areas to be up to 10% over the maximum line loads induced by the dimensioning load (deduced from QSL table). An adapter mathematical model can be provided to assess these values.

4.2.4.3. Handling loads during ground operations

During the encapsulation phase, the S/C is lifted and handled with its adapter. The S/C and its handling equipment must then be capable of supporting an additional mass of 200 kg. The crane characteristics, velocity and acceleration are defined in the EPCU User's Manual.

4.2.4.4. Dynamic loads

The secondary structures and flexible elements (e.g. solar panels, antennae...) must be designed to withstand the dynamic environment described in chapter 3 and must take into account the safety factors defined in paragraph 4.3.2.

4.2.5. Spacecraft RF emission

To prevent the impact of spacecraft RF emission on the proper functioning of the L/V electronic components and RF systems during ground operations and in flight, the spacecraft should be designed to respect the L/V susceptibility levels given in figure 4.2.5.a (free space conditions). In particular, the spacecraft must not overlap the frequency bands of the L/V receivers 2206.5 MHz, 2227 MHz, 2254.5 MHz, 2267.5 MHz and 2284 MHz with a margin of 1 MHz.

Spacecraft transmission is allowed during ground operations. Authorization of transmission during countdown, and/or flight phase and spacecraft separation will be considered on a case by case basis.

If the spacecraft needs to have its TM "ON" during ground operation and after encapsulation and during flight, figure 4.2.5.b. presents the maximum global emission power under cavity (fairing or SYLDA) acceptable to the launch vehicle. This maximum power is to be understood as the sum of all the spacecraft RF sources at antenna output (without gain).

In any case, no change of the spacecraft RF configuration (no frequency change, no power change) is allowed from H0-1h30m until 20 s after separation.

During the launch vehicle flight until separation of the spacecraft no uplink command signal can be sent to the spacecraft or generated by a spacecraft on-board system (sequencer, computer, etc...).

For dual launch, in certain cases, a transmission time sharing plan may be set-up on Arianespace request.

A 35 dB μ v/m level radiated by the spacecraft, in the launch vehicle telecommand receiver 420-480 MHz band, shall be considered as the worst case of the sum of spurious level over a 100 kHz bandwidth.



Figure 4.2.5.a – Spurious radiations acceptable to launch vehicle
Narrow-band electrical field measured 1.0 m below
the separation plane (free space)

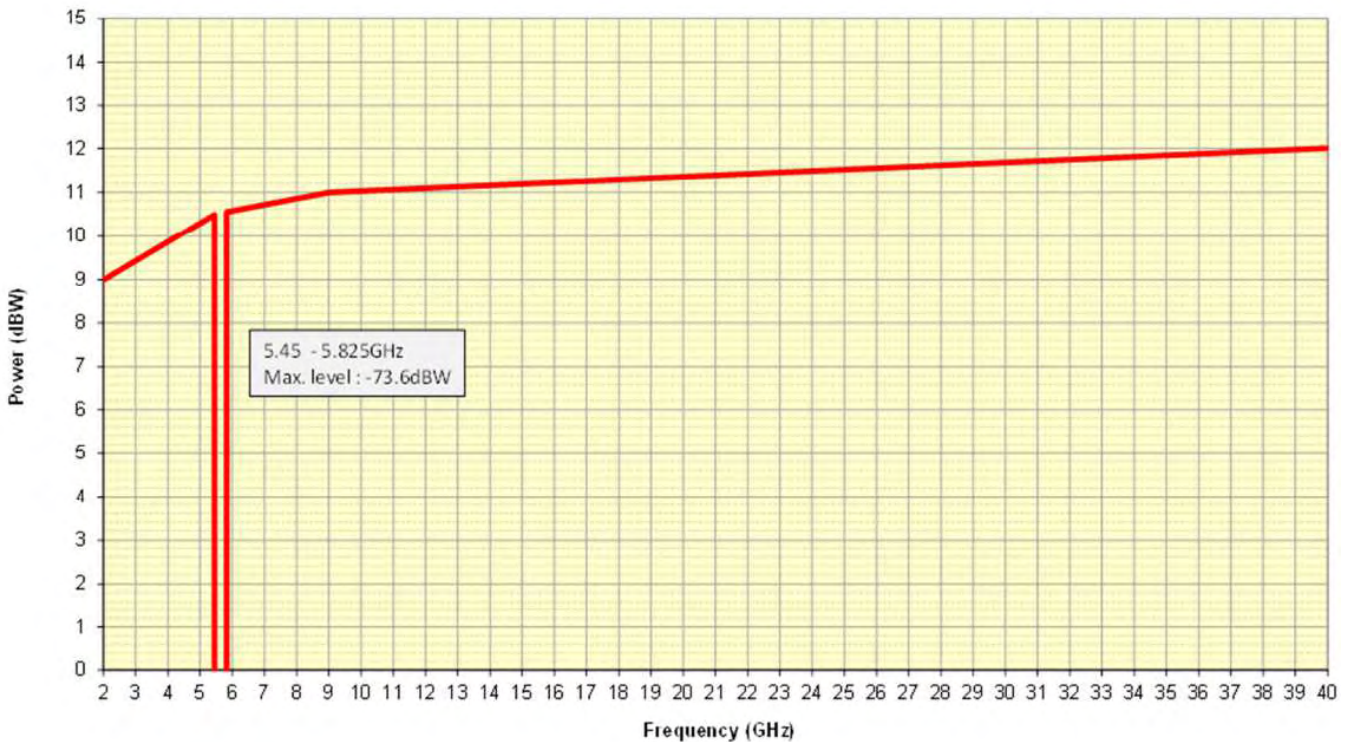

Figure 4.2.5.b. Intentional emission power (under cavity)
acceptable to launch vehicle

4.3. Spacecraft compatibility verification requirements

4.3.1. Verification Logic

The spacecraft authority shall demonstrate that the spacecraft structure and equipments are capable of withstanding the maximum expected launch vehicle ground and flight environments.

The spacecraft compatibility must be proven by means of adequate tests. The verification logic with respect to the satellite development program approach is shown in table 4.3.1.a.

S/C development approach	Model	Static	Sine vibration	Acoustic	Shock
With Structural Test Model (STM)	STM	Qual. test	Qual. test	Qual. test	Shock test characterization and analysis
	FM1	By heritage from STM *	Protoflight test	Protoflight test	Shock test characterization and analysis or by heritage*
	Subsequent FM's**	By heritage from STM *	Acceptance test (optional)	Acceptance test	By heritage* and analysis
With ProtoFlight Model	PFM = FM1	Qual test or by heritage *	Protoflight test	Protoflight test	Shock test characterization and analysis or by heritage*
	Subsequent FM's**	By heritage *	Acceptance test (optional)	Acceptance test	By heritage* and analysis

* If qualification is claimed "by heritage", the representativeness of the structural test model (STM) with respect to the actual flight unit must be demonstrated.

** Subsequent FM's: identical to FM1: same primary structure, major subsystems and appendages.

Table 4.3.1.a – Spacecraft verification logic for structural tests

The mechanical environmental test plan for spacecraft qualification and acceptance shall comply with the requirements presented hereafter and shall be reviewed by Arianespace prior to implementation of the first test.

The purpose of ground testing is to screen out unnoticed design flaws and/or inadvertent manufacturing and integration defects or anomalies. It is therefore important that the satellite be mechanically tested in flight like configuration. Should significant changes affect the tested configuration during subsequent AIT phase, prior to S/C shipment to CSG, the need to re-perform some mechanical tests must be reassessed. If, in spite of notable changes, complementary mechanical testing is not considered necessary by the customer, this situation should be treated in the frame of a request of waiver, which shall demonstrate acceptable margins and in particular, the absence of risk for the launcher. Also, it is suggested that customers will implement tests to verify the susceptibility of the spacecraft to the thermal and electromagnetic environment and will tune, by this way, the corresponding spacecraft models used for the mission analysis.

4.3.2. Safety factors

Spacecraft qualification and acceptance test levels are determined by increasing the design load factors (the flight limit levels) — which are presented in chapters 3 and 4 — by the safety factors given in table 4.3.2.a. The spacecraft must have positive margins of safety for yield and ultimate loads.

S/C tests	Qualification*		Protoflight		Acceptance	
	Factors	Duration/Rate	Factors	Duration/Rate	Factors	Duration/Rate
Static (QSL)	1,25	N/A	1,25	N/A	N/A	N/A
Sine vibrations	1,25	2 oct/min	1,25	4 oct/min	1.0	4 oct/min
Acoustics	+3 dB (or 2)	120 s	+3 dB (or 2)	60 s	1.0	60 s
Shock	+3 dB (or 1.41)	N/A	+3 dB (or 1.41)	N/A	N/A	N/A

Table 4.3.2.a - Test factors, rate and duration

* If qualification is not demonstrated by test, it is reminded that a safety factor of 2 (margin $\geq 100\%$) is requested with respect to the design limit.

4.3.3. Spacecraft compatibility tests

4.3.3.1. Static tests

Static load tests (in the case of a STM approach) are performed by the customer to confirm the design integrity of the primary structural elements of the spacecraft platform. Test loads are based on worst-case conditions, i.e. on events that induce the maximum interface loads into the main structure, derived from the table of maximum QSLs and taking into account the additional line loads peaking.

The qualification factors given above shall be considered.

4.3.3.2. Sinusoidal vibration tests

The objective of the sine vibration tests is to verify the spacecraft secondary structure qualification under the dimensioning loads (cf. para. 3.2.3.) multiplied by the appropriate safety factors

Nota: For S/C subsystems or equipment, of which qualification is not verified during S/C sine tests or unit elementary tests, a design margin of minimum 2 is to be demonstrated by analysis.

The spacecraft qualification test consists of one sweep through the specified frequency range and along each axis.

Flight limit amplitudes are specified in chapter 3 and are applied successively on each axis. The tolerance on sine amplitude applied during the test is $\pm 10\%$. A notching procedure may be agreed on the basis of the latest coupled loads analysis (CLA) available at the time of the tests to prevent excessive loading of the spacecraft structure or equipment. However, it must not jeopardize the tests objective to demonstrate positive margins of safety with respect to the flight loads.

Sweep rates may be modified on a case-by-case basis depending on the actual damping of the spacecraft structure. This is done while maintaining the objective of the sine vibration tests.

Sine	Frequency range (Hz)	Qualification levels (0-peak)	Protoflight levels (0-peak)	Acceptance levels (0-peak)
Longitudinal	2-5*	12.4 mm	12.4 mm	9.9 mm
	5-50	1.25 g	1.25 g	1 g
	50-100	1 g	1 g	0.8 g
Lateral	2-5	9.9 mm	9.9 mm	8.0 mm
	5-25	1 g	1 g	0.8 g
	25-100	0.8 g	0.8 g	0.6 g
Sweep rate		2 oct./min	4 oct./min	4 oct./min

Table 4.3.2.a – Sinusoidal vibration tests levels

* Pending on the potential limitations of the manufacturer's test bench, the fulfillment of the requirement in that particular frequency range can be subject to negotiation in the field of a request for waiver process, and providing that the S/C does not present internal modes in that range.

4.3.3.3. Acoustic vibration tests

Acoustic testing is accomplished in a reverberant chamber applying the flight limit spectrum provided in chapter 3 and increased by the appropriate safety factors. The volume of the chamber with respect to that of the spacecraft shall be sufficient so that the applied acoustic field is diffuse. The test measurements shall be performed at a minimum distance of 1 m from the spacecraft.

Octave band centre frequency (Hz)	Qualification Level (dB)	Protoflight Level (dB)	Acceptance level (flight) (dB)
	ref: 0 dB = 2×10^{-5} Pascal		
31.5	131	131	128
63	134	134	131
125	139	139	136
250	136	136	133
500	132	132	129
1000	126	126	123
2000	119	119	116
Overall level	142.5	142.5	139.5
Test duration	2 minutes	1 minute	1 minute

Table 4.3.3.3.a – Acoustic vibration test levels

For the anechoic chamber, the following dispersion is allowed between the microphone measurements:

- 2, +4 dB for 31.5 Hz band
- 1, +3 dB for following bands

For each octave, the levels to be achieved provided in table 4.3.3.3.a are applicable to the average of the microphones' measurements.

Fill factor

Special consideration shall be given to spacecraft which fill factor, calculated as the ratio of the maximum horizontal cross area of spacecraft including its appendages solar panels and antennae over the fairing is greater than 60 %.

Fill factor	0 to 60 %	60% to 85%	85%
Fill factor correction	0 %	Linear interpolation	100 %

100 % of fill factor correction corresponds to +4 dB at 31.5 Hz and + 2 dB at 63 Hz.

4.3.3.4. Shock qualification

With the introduction of the new fairing separation system (HSS3+), the dimensioning shock event is the spacecraft separation.

The demonstration of the spacecraft's ability to withstand the separation shock generated by the L/V shall be based on one of the following methods:

Method Number One:

One Drop-test is conducted with the tension of the band set as close as possible to its maximum value during flight. During this test, interface shock levels and unit shock levels are measured. This test must be performed on a flight representative specimen, which could be a flight model (PFM or FM) or an STM provided that it is representative in terms of primary structure, subsystems and equipment layout and fixation modes.

For each spacecraft subsystem and/or equipment, the induced shock measured during the above-mentioned test is then increased by:

- A +3db uncertainty margin aiming at deriving flight limit environment from the single test performed in flight-like configuration;
- A +3dB safety factor aiming at defining the required minimum qualification levels, to be compared to the qualification status of each spacecraft subsystem and/or equipment.

These obtained shock levels are then compared to the qualification status of each spacecraft subsystem and/or equipment. Note that each unit qualification status can be obtained from environmental qualification tests other than shock tests by using equivalent rules (e.g. from sine or random vibration tests).

Nota 1: if 2 clampband release tests or more are being performed, and the test envelop responses is being used, the +3dB margin for uncertainties can be removed.

Nota 2: If, during the test, equipment's are not representative of the flight model, the qualification of these elements shall be demonstrated at unit level using the applicable shock specification recalled in paragraph 3.2.6 as input at spacecraft interface with launch vehicle.

Nota 3: if the clampband separation shock level recorded at the spacecraft base is below $0.2xf$, in some frequency ranges, then the test levels need to be extrapolated to this minimum value of $0.2 \times f$ (including uncertainty margin on transfer functions), corresponding to the maximum shock to be accounted for the launcher separation events.

Method Number Two:

In case of recurring platform or spacecraft, the qualification to the Clamp-Band shock event can be based on heritage, pending that identical platform or spacecraft is already qualified to the Clamp-Band shock event for a tension identical or higher than the one targeted for the on-going satellite.

For each spacecraft subsystem and/or equipment, an envelope of the induced shocks measured during the previous tests with identical platform or spacecraft is to be considered.

These levels, increased by a +3dB safety factor aiming at defining the required minimum qualification levels, are compared to the qualification status of each spacecraft subsystem and/or equipment.

These obtained shock levels are then compared to the qualification status of each spacecraft subsystem and/or equipment. Note that each unit qualification status can be obtained from

environmental qualification tests other than shock tests by using equivalent rules (e.g. from sine or random vibration tests).

If some spacecraft subsystem and/or equipment of the on-going satellite present no heritage, the qualification of these elements shall be demonstrated at unit level using the applicable shock specification recalled paragraph 3.2.6 as input at spacecraft interface with launch vehicle.

Spacecraft interfaces

Chapter 5

5.1. Introduction

The Ariane 5 launch vehicle provides standard interfaces that fit all spacecraft buses and allow an easy switch between the launch vehicles of the European transportation fleet.

This chapter covers the definition of the spacecraft interfaces with the payload adapter, the fairing, the SYLDA 5 and the on-board and ground electrical equipment.

The spacecraft is mated to the L/V through a dedicated structure called adapter that provides mechanical interface, electrical harnesses routing and systems to ensure the spacecraft separation. Off-the-shelf adapters, with separation interface diameter of 937 mm, 1194 mm, 1663 mm, 1666 mm and 2624 mm are available.

For a spacecraft in single launch, the fairing protects the spacecraft mounted on top of an adapter which can be a standard Ariane or customer's design.

For dual launch, the configuration comprises one carrying structure, the SYLDA 5:

- the fairing protects the upper spacecraft mounted on top of an adapter (standard Ariane or customer's design) fixed on to the SYLDA 5 upper interface flange,
- the SYLDA 5 protects the lower spacecraft mounted on top of an adapter (standard Ariane or customer's design) fixed on the launcher interface flange,

The electrical interface provides communication with the launch vehicle and the ground support equipment during all phases of spacecraft preparation, launch and flight.

5.2. The reference axes

All definition and requirements shall be expressed in the same reference axis system to facilitate the interface configuration control and verification.

Figure 5.2.a shows the reference axis system of Ariane 5.

The clocking of the spacecraft with regard to the launch vehicle axes is defined in the Interface Control Document taking into account the spacecraft characteristics (volume, access needs, RF links,...).

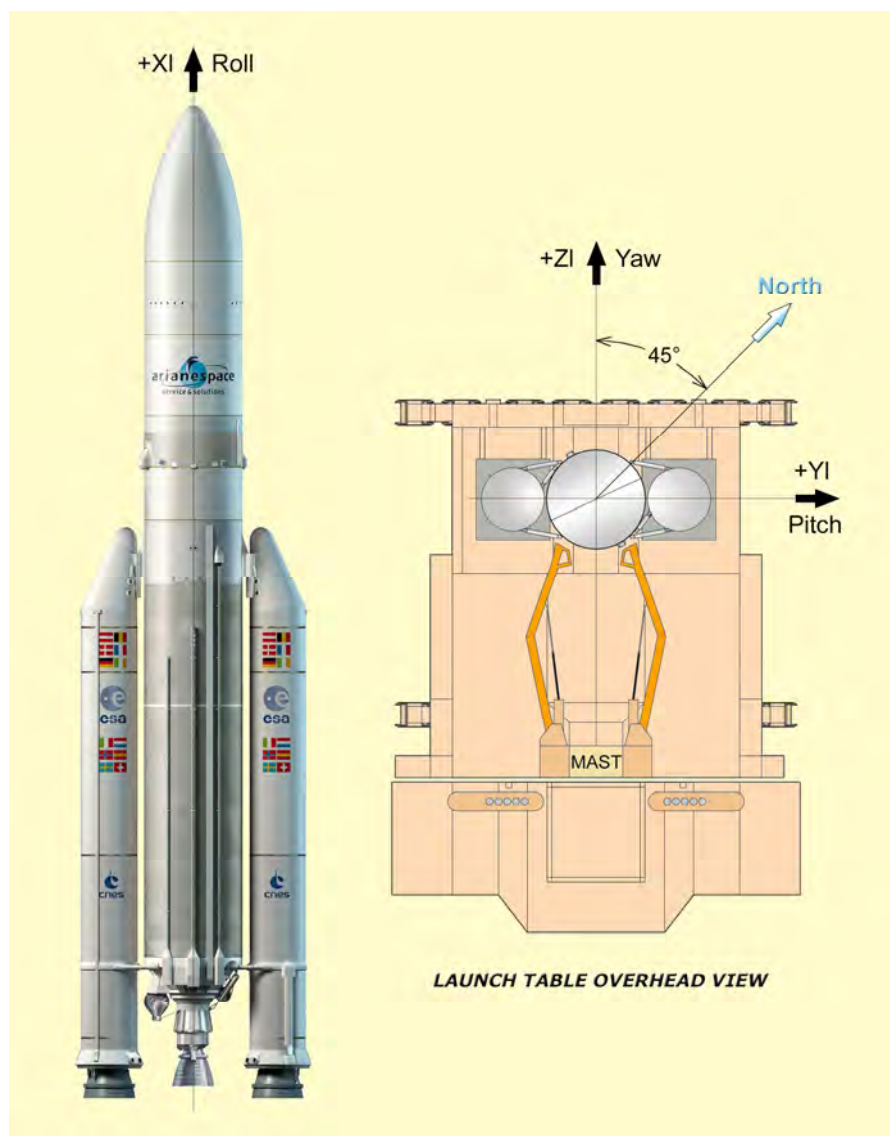

Figure 5.2.a – Ariane 5 coordinate system

5.3. Encapsulated spacecraft interfaces

5.3.1. Payload usable volume definition

The payload usable volume is the area under the fairing or the SYLDA 5 available to the spacecraft mated on the adapter. This volume constitutes the limits that the static dimensions of the spacecraft, including manufacturing tolerance, thermal protection installation, appendices,... shall not exceed.

It has been established having regard to the potential displacement of the spacecraft complying with frequency requirements described in the Chapter 4.

Allowance has also been made for manufacturing and assembly tolerances of the upper part structures (fairing, dual launch structure, adapter, vehicle equipment bay, upper stage), for all displacements of these structures under ground and flight loads, and for necessary clearance margin during SYLDA 5 separation.

In the event of local protrusions located slightly outside the above-mentioned envelope, Arianespace and the customer can conduct a joint investigation in order to find the most suitable layout.

The payload usable volume is shown in annex 5.

The allocated volume envelope in the vicinity of the adapter is described in the annexes dedicated to each off-the-shelf adapter.

Accessibility to the mating interface, separation system functional requirements and non-collision during separation are also considered for its definition.

5.3.2. Spacecraft accessibility

The encapsulated spacecraft can be accessible for direct operations until D-2 before lift-off through the access doors of the fairing and the access holes of the SYLDA 5. If access to specific areas of spacecraft is required, additional doors can be provided on a mission-specific basis. Doors and holes shall be installed in the authorized areas described in annex 6.

The same procedure is applicable to the optional radio-transparent windows, for which the authorized areas are described in annex 6. The radio-transparent window may be replaced by RF repeater antenna.

5.3.3. Special on-fairing insignia

A special mission insignia based on Customer supplied artwork can be placed by Arianespace on the cylindrical section of the fairing. The dimensions, colors, and location of each such insignia are subject to mutual agreement. The artwork shall be supplied not later than 6 months before launch.

5.3.4. Payload compartment description

Nose fairing description

The Ariane 5 nose fairing consists of a two half-shell carbon fiber structure with a longitudinal Ariane type separation system. This nose fairing has an external diameter of 5.4 m.

Separation of the nose fairing is obtained by means of two separation systems. An horizontal one (HSS) made of a pyrotechnical expansion tube which connects the fairing to the Vehicle Equipment Bay, and a vertical one (VSS) that consists of a pyrotechnic cord, located close to the plane joining the two half-shells.

This cord shears the rivets connecting the two parts, and imparts a lateral impulse to the half-fairings, driving them apart by a piston effect. The gases generated by the system are retained permanently inside an envelope, thus avoiding any contamination of the spacecraft by the separation system. HSS and VSS are ignited by the two different pyrotechnical orders separated by 56ms.

SYLDA 5 carrying structure description (see picture 5.3.4.a)

The SYLDA 5 consists of a load bearing carbon structure, comprising a conical adapter fixed to the Vehicle Equipment Bay, a cylindrical shell of variable length from 2.9 to 4.4 m by 300 mm steps enclosing the lower spacecraft and an upper truncated conical shell supporting the upper spacecraft.

Separation of the SYLDA 5 structure is achieved by means of a HSS which cuts the SYLDA 5 structure along a horizontal plane at the level of the conical/cylindrical lower interface. Springs impart an impulse to jettison the SYLDA 5.



**Picture 5.3.4.a – SYLDA 5
Internal carrying structure**

5.4. Mechanical Interface

Ariane 5 offers a range of standard off-the-shelf adapters and their associated equipment, compatible with most of the spacecraft platforms. These adapters belong to the family of the Arianespace adapters providing the same interface definition on the spacecraft side for all the launch vehicles.

The customer will take full advantage of the flight proven off-the-shelf adapters. Nevertheless dedicated adapter or dispenser (especially in the case of dispensers) can be designed to address specific customer's needs and requirements.

All adapters are equipped with a separation system and brackets for electrical connectors.

Except for the 1663 mm adapter, the separation system consists of a clamp band set, a release mechanism and separation springs. For the 1663 mm adapter, the separation system is made of 4 pyrotechnic separation bolts and springs.

The electrical connectors are mated on two brackets installed on the adapter and spacecraft side. On the spacecraft side, the umbilical connector's brackets must be stiff enough to prevent any deformation greater than 0.5 mm under the maximum force of the connector spring.

Adaptation for a GN₂ purging connector at the spacecraft interface can be provided as an option. Customer is requested to contact Arianespace for further details.

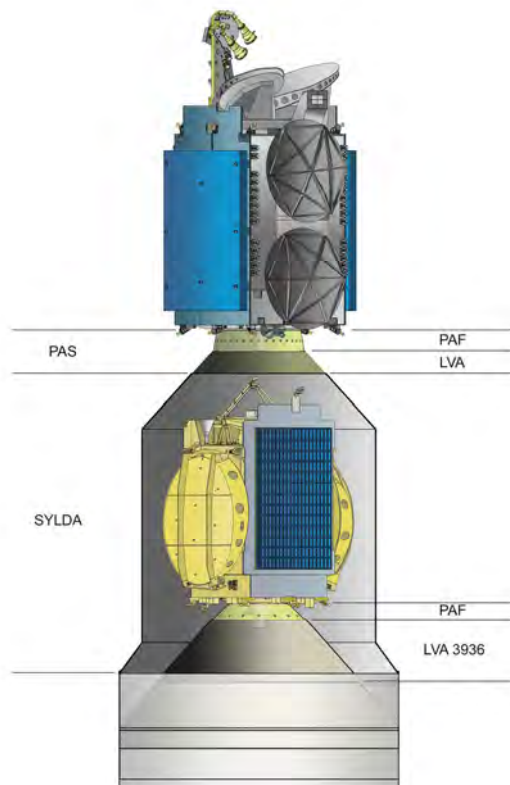

In upper position, the S/C adapter (PAS) is either composed of 2 parts: payload adapter fitting (PAF) and launch vehicle adapter (LVA), or in one single part mounted on the SYLDA upper interface (Ø2624mm).

In lower position under SYLDA, the S/C adapter is composed of a PAF directly mounted on LVA 3936 upper interface (Ø1780). The LVA 3936 is optimized for the accommodation of S/C with limited mass in lower position under SYLDA in dual launch configuration. Should the S/C in lower position exceeds the actual carrying capability of the LVA 3936 structure, the LVA 3936 will be replaced by the (LVA 2624 + cone 3936) assembly.

The general characteristics of the Ariane 5 standard adapters are presented in table 5.4.a. A more detailed description is provided in annexes 7 to 12.

Note:

In some situations, the customer may wish to assume responsibility for spacecraft adapter. In such cases, the customer shall ask for Arianespace approval and corresponding requirements. Arianespace will supervise the design and production of such equipment to insure the compatibility at system level.

Adapter	Description	Separation system
PAS 937S	Height: 883 mm Max mass: 155 kg Aluminum upper structure (PAF) and composite lower part (LVA 2624)	Clamp band Ø937 with low shock separation system (CBOD) (RUAG Space)
PAS 937C	Height: 925 mm Max mass: 155 kg or 175 kg with a Ø1780 interface (Variant A) Cone and lower ring: monolithic carbon Upper ring: aluminum	Clamp band Ø937 with low shock separation system (LPSS*) (AIRBUS DS Spain)
PAS 1194VS	Height: 753 mm Max mass: 150 kg Aluminum upper structure (PAF) and composite lower part (LVA 2624)	Clamp band Ø1194 with low shock separation system (CBOD) (RUAG Space)
PAS 1194C	Height: 790 mm Max mass: 150 kg or 180 kg with a Ø1780 interface (Variant A) Cone and lower ring: monolithic carbon Upper ring: aluminum	Clamp band Ø1194 with low shock separation system (LPSS*) (AIRBUS DS Spain)
PAS 1663	Height: 886 mm Max mass: 165 kg Aluminum upper structure (PAF) and composite lower part (LVA 2624)	4 bolts with pyrotechnic separation nuts (Hi-Shear)
PAS 1666MVS	Height: 886 mm Max mass: 160 kg Aluminum upper structure (PAF) and composite lower structural part (LVA 2624)	Clamp band Ø1666 with low shock separation system (CBOD) (RUAG Space)
PAS 1666S	Height: 882 mm Max mass: 195 kg Aluminum upper structure (PAF) and composite lower part (LVA 2624)	Clamp band Ø1666 with low shock separation system (CBOD) (RUAG Space)
PAS 2624VS	Height: 175 mm (Variant A) or 325 mm (Variant B) Max mass: 100 kg (Var. A) or 125 kg (Var. B) Aluminum structure	Clamp band Ø2624 with low shock separation system (CBOD) (RUAG Space)
Raising cylinder: ACY 1780	Height: adjustable between 70 and 300 mm Max mass: 45 kg Aluminum structure It can be used with all the adapters except with the PAS 1666S, PAS 2624VS	N/A

Table 5.4.a – Ariane 5 standard adapters

5.5. Electrical and radio electrical interfaces

The needs of communication with the spacecraft during the launch preparation and the flight require electrical and RF links between the spacecraft, the L/V, and the EGSE located at the launch pad and preparation facilities.

The electrical interface composition between spacecraft and Ariane 5 is presented in the table 5.5.a.

All other data and communication network used for spacecraft preparation in the CSG facilities are described in chapter 6.

The requirements for the spacecraft connector bracket stiffness are described in paragraph 5.4.

Service	Description	Lines definition	Provided as	I/F connectors*
Umbilical lines	Spacecraft TC/TM data transmission and battery charge	74 lines (see §5.5.1)	Standard	2 × 37 pin DBAS 70 37 0 SN DBAS 70 37 0 SY
L/V to S/C services	Dry loop commands	(see §5.5.2.1)	Optional	2 × 61 pin is acceptable
	Electrical commands	(see §5.5.2.2)	Optional	
	Spacecraft TM retransmission	(see §5.5.2.3)	Optional	
	Additional power supply during flight	(see §5.5.2.4)	Optional	
	Pyrotechnic command	(see §5.5.2.5)	Optional	2 × 12 pin DBAS 70 12 0 SN DBAS 70 12 0 SY
RF link	Spacecraft TC/TM data transmission	RF transparent window or passive repeater (see §5.5.4)	Optional	N/A

* Arianespace will supply the customer with the spacecraft side interface connectors compatible with equipment of the off-the-shelf adapters.

Table 5.5.a - Spacecraft electrical and radio electrical interfaces

Flight constraints

During the powered phase of the launch vehicle and up to separation of the spacecraft, no command signal can be sent to the spacecraft, or generated by a spacecraft onboard system (sequencer, computer, etc.). During this powered phase a waiver can be studied to make use of commands defined in this paragraph providing that the radio electrical environment is not affected.

After the powered phase and before the spacecraft separation, the commands defined in this paragraph can be provided to the spacecraft.

To command operations on the spacecraft after separation from the launch vehicle, microswitches or telecommand systems (after 20 s) can be used. Initiation of operations on the spacecraft after separation from the launch vehicle, by a payload on-board system programmed before lift-off, must be inhibited until physical separation.

	H0 - 1h30 mn ▼	Upper stage burn-out ▼	Separation ▼	Separation + 20 s ▼
Command	NO	NO	NO	YES
Spacecraft Sequencer	NO	NO	YES	YES
L/V orders	NO (waiver possible)	YES	NO	NO

5.5.1. Spacecraft to EGSE umbilical lines

Between the base of the spacecraft adapter and the umbilical mast junction box, 74 wires will be made available for each spacecraft.

If more lines are requested, please contact Arianespace as some specific configurations can be studied on a case by case basis.

The characteristics of these umbilical links are:

- resistance $< 1.2 \Omega$ between the upper or lower connecting box and the electrical umbilical plug (Spacecraft to adapter umbilical connectors)
- insulation $> 5 \text{ M}\Omega$ under 500 Vdc

Operating constraints:

- each wire shall not carry current in excess of 7.5 A
- the voltage is $\leq 150 \text{ Vdc}$
- no current shall circulate in the shielding
- the spacecraft wiring insulation is $> 10 \text{ M}\Omega$ under 50 Vdc
- refer also to the dedicated wiring diagram

The outline of the umbilical lines between a spacecraft encapsulated on Ariane 5 and its Electrical Ground Support Equipment located in the satellite control room is shown in figure 5.5.1.a.

The Customer shall design his spacecraft so that during the final preparation leading up to actual launch, the umbilical lines are carrying only low currents at the moment of lift-off, i.e. less than 100 mA – 150 V and a maximum power limitation of 3 W. Spacecraft power must be switched from external to internal, and ground power supply must be switched off before lift-off.

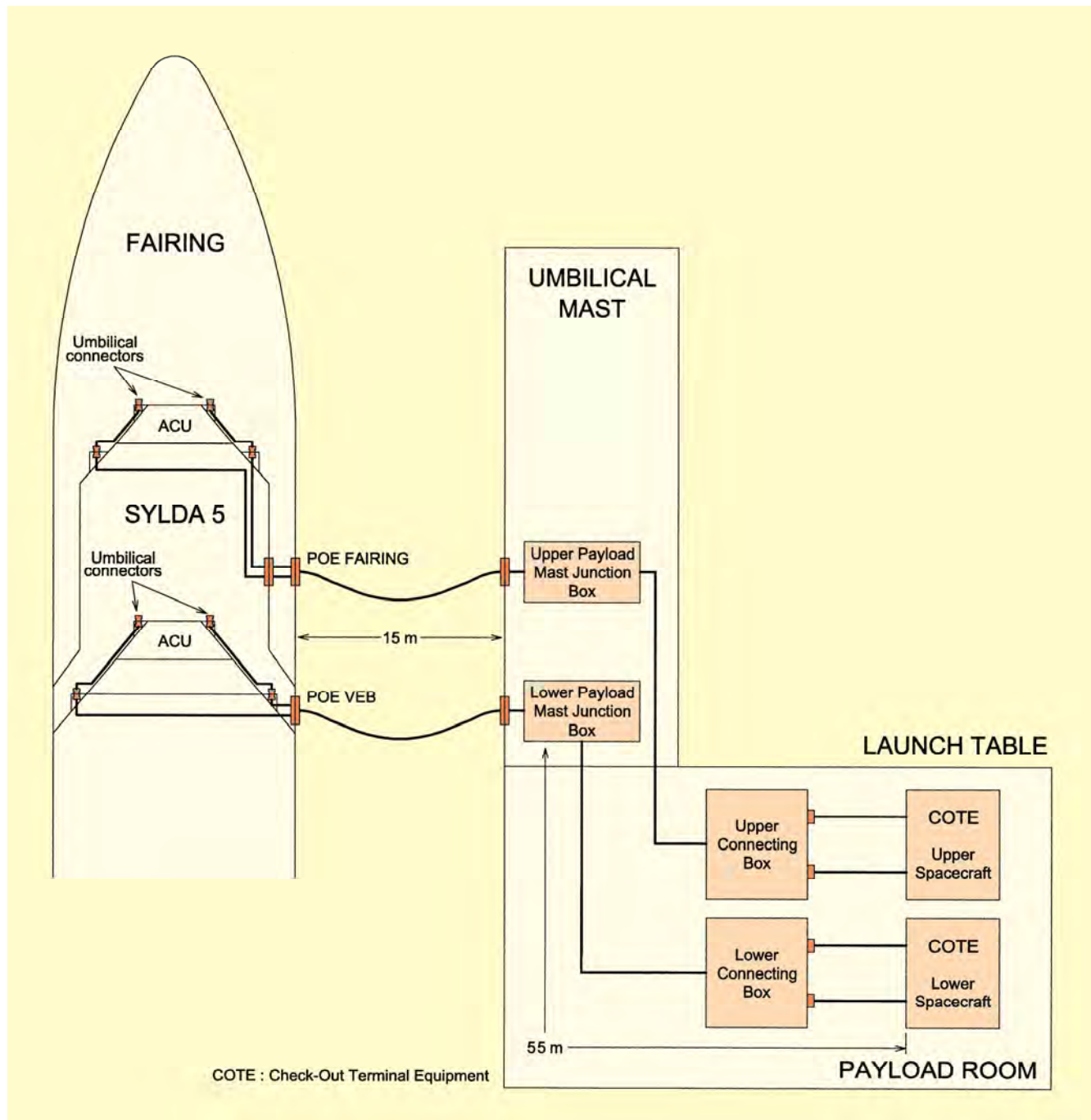

Figure 5.5.1.a – Umbilical links between S/C mated on the Launcher and its Check-Out Terminal Equipment

5.5.2. The L/V to spacecraft electrical functions

The launch vehicle can provide optional electrical functions used by the spacecraft during flight.

Due to the spacecraft to launch vehicle interface, the customer is required to protect the circuit against any overload or voltage overshoot induced by his circuits both at circuits switching and in the case of circuit degradation.

To protect spacecraft equipment a safety plug with a shunt on S/C side and a resistance of $2\text{ k}\Omega \pm 1\%$ (0.25 W) on the L/V side shall be installed in all cases.

5.5.2.1. Dry loop command (Optional)

Per spacecraft, 4 redundant commands are available for electrical and dry-loop commands.

The main electrical characteristics are:

- Loop closed $R \leq 1.5\ \Omega$
- Loop open $R \geq 100\ \text{M}\Omega$
- Voltage & current domain from S/C side to be compliant with LV requirement included in
 - $\leq 55\text{V}$ $\leq 0.35\text{A}$
 - $\leq 35\text{V}$ $\leq 0.5\text{A}$
 - Other tuning can be accepted on request
- Launcher on board circuit insulation $\geq 100\ \text{M}\Omega$ under 50 Vdc

Protection: the customer is required to protect the circuit against any overload or voltage overshoot induced by his circuits both at circuits switching and in the case of circuit degradation.

The customer has to intercept the launcher command units (prime and redundant) in order to protect the S/C equipment and to allow the integration check-out by using a safety plug equipped with an open circuit on the S/C side and a short circuit on the L/V side.

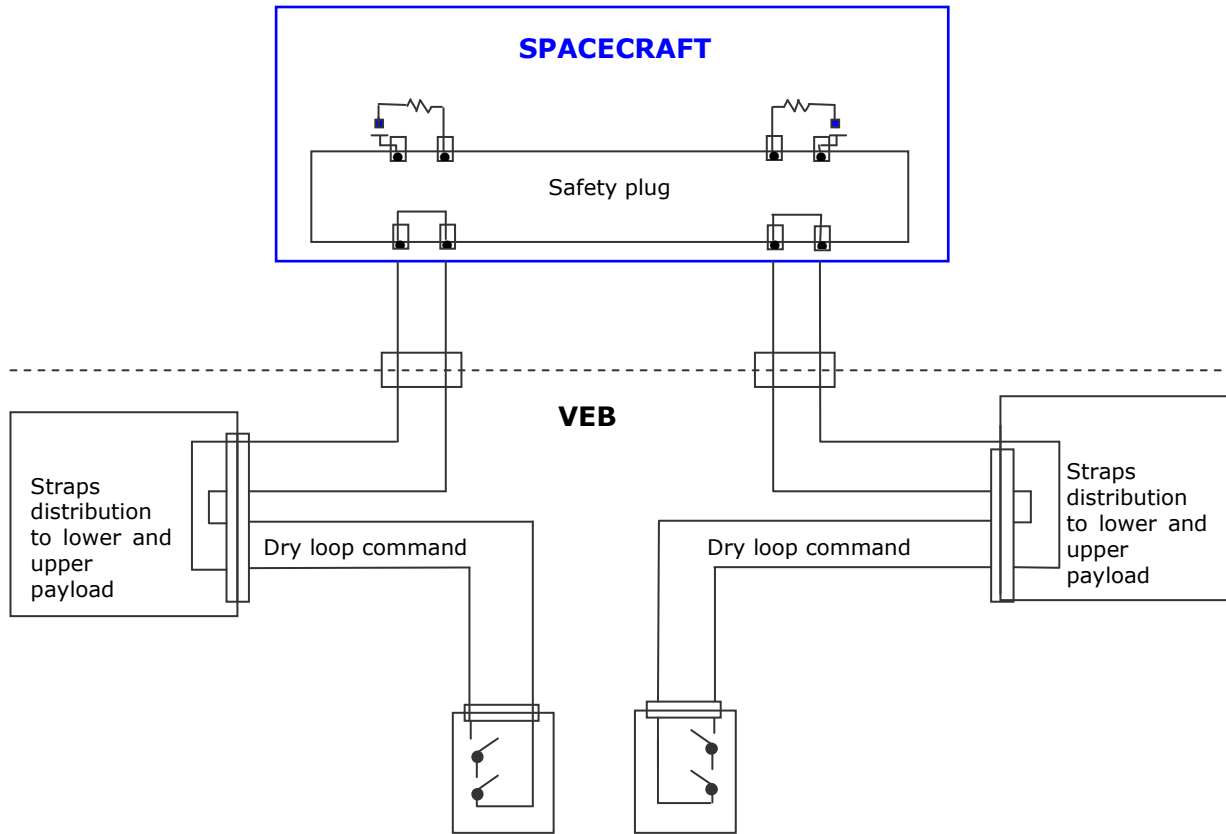

Figure 5.5.2.1.a - Dry loop command diagram

5.5.2.2. Electrical command (Optional)

Per spacecraft, 4 redundant commands are available for electrical and dry-loop commands:

- Output voltage $28\text{ V} \pm 4\text{ V}$
- Current $\leq 0.5\text{ A}$

Protection: the customer is required to protect the circuit against any overload or voltage overshoot induced by his circuits both at circuits switching and in the case of circuit degradation. The customer has to intercept the launcher command units (prime and redundant) in order to protect the S/C equipment and to allow the integration check-out by using a safety plug equipped with an open circuit on the S/C side and a short circuit on the L/V side.

Main utilization constraints (S/C side):

- The customer is required to use two independent loads, one on each redundant line. If a unique load is used, then a protection circuit is necessary up-stream of the summing-up points.
- The customer is required to dimension his load circuit so that the current drawn remains below the following curve.

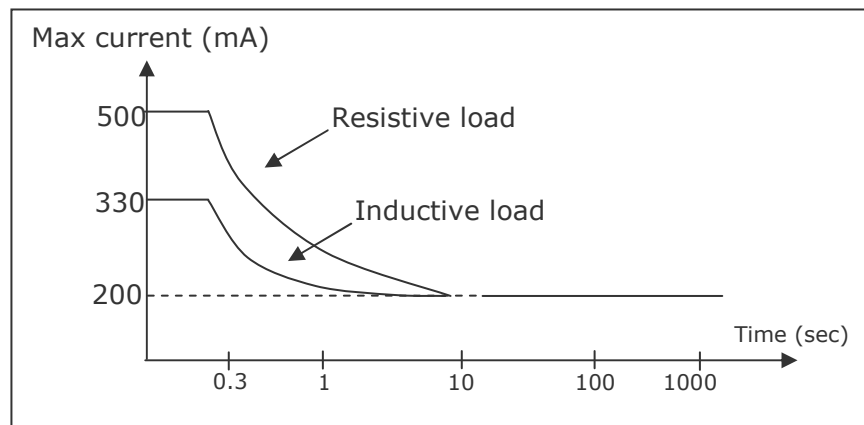

Figure 5.5.2.2.a – Maximum current curve

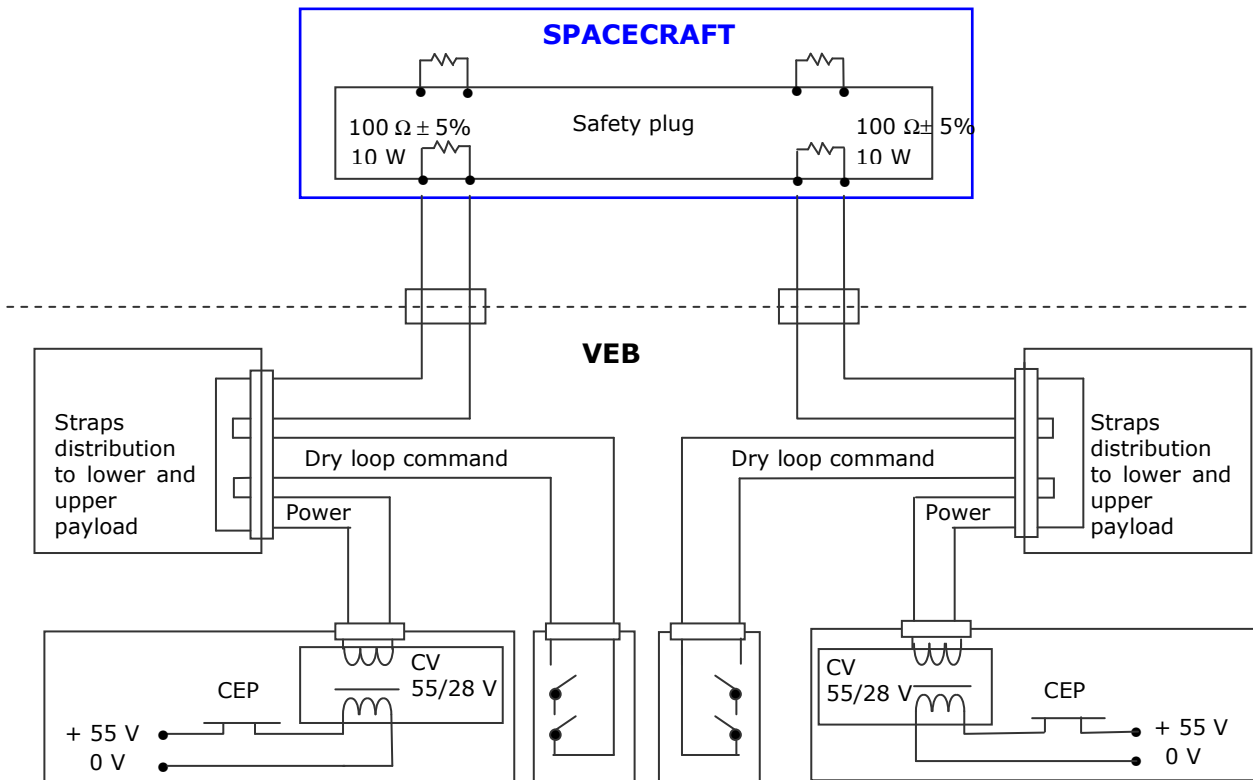

Figure 5.5.2.2.b - Electrical command diagram

5.5.2.3. Spacecraft telemetry transmission (Optional)

In flight transmission of spacecraft measurements by the L/V telemetry system can be studied on a case by case basis. A customer wishing to exercise such an option should contact Arianespace for interface characteristics.

5.5.2.4. Power supply to spacecraft (Optional)

A power supply is available for the customer as an optional service.

The main characteristics are:

- Input voltage $28\text{ V} \pm 4\text{ V}$
- Nominal current $\leq 2\text{ A}$
- Capacity 1.6 Ah

A non-standard voltage can be made available for an electrical command. The customer should contact Arianespace for this option.

5.5.2.5. Pyrotechnic command (Optional)

A total of 3 pyrotechnic commands (per launcher) is available for the customer's pyrotechnic system other than the separation system.

Each command can initiate 1 squib and is fully redundant, i.e. two totally separate lines provide the same command simultaneously, the power being supplied from separate batteries.

These commands can be segregated from the umbilical lines and other commands by means of specific connectors.

The main electrical characteristics are:

- Voltage (no-load) $28\text{ V} \pm 4\text{ V}$
- Pulse Width $25\text{ ms} \pm 5\text{ ms}$
- Output insulation $\geq 100\text{ k}\Omega$
- Current 4.1 A (for standard squibs $1.05\ \Omega$)

The execution of the pyrotechnic command (pyrotechnics voltage at sequencing unit output) is monitored by the launcher telemetry system.

The insulation between wires (open loop) and between wires and structure must be $\geq 100 \text{ k}\Omega$ under 10 Vdc.

The Customer has to intercept the launcher command circuits (prime and redundant) in order to protect the S/C equipment and to allow the integration check-out by using a safety plug equipment with a shunt on S/C side and a resistance of $2 \text{ k}\Omega \pm 1\%$ (0.25 W) on the L/V side.

The S/C has to allow the L/V to check the proper address and command of the S/C pyro equipment (ordered by the L/V)

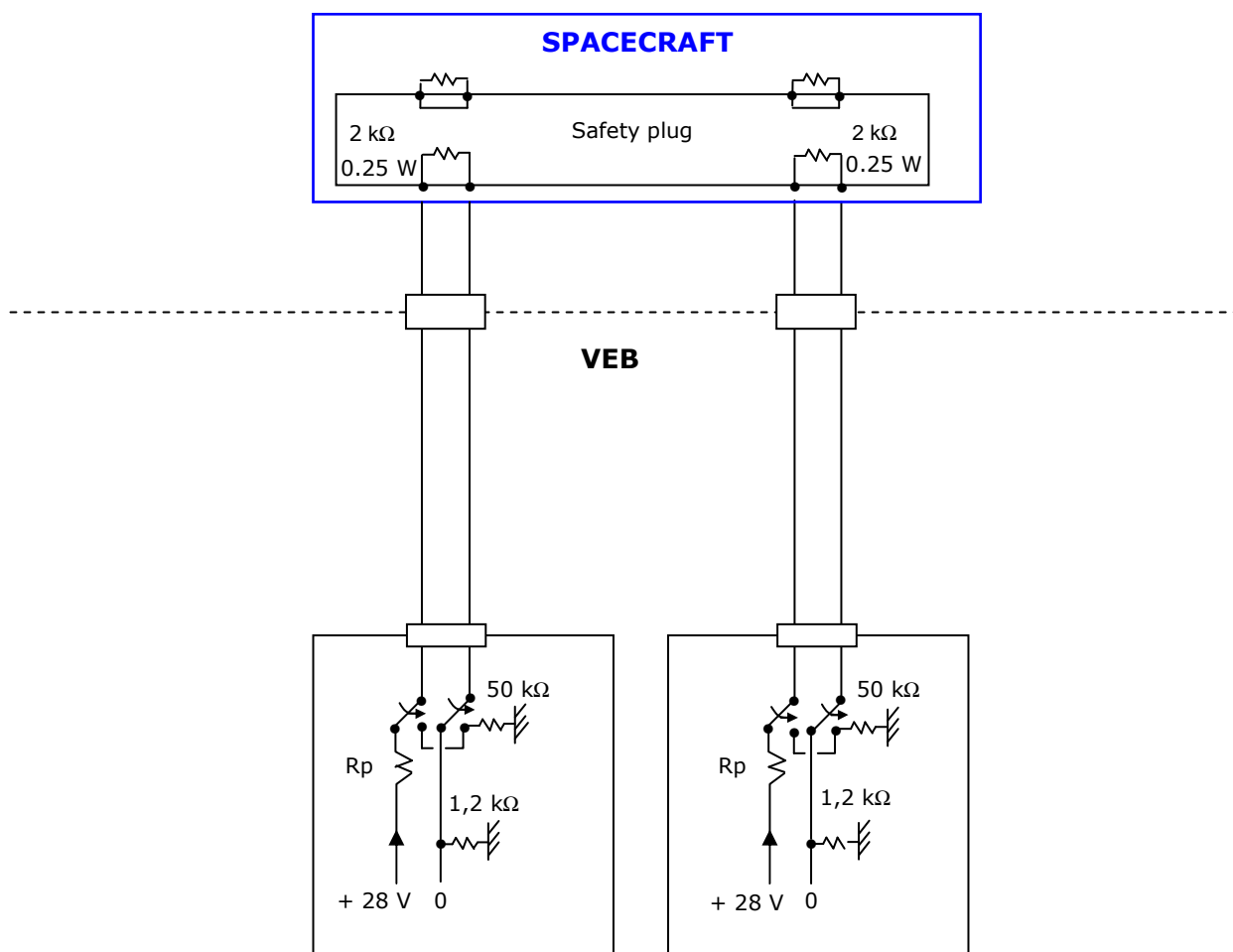

Figure 5.5.2.5.a - Pyrotechnical command diagram

5.5.3. Electrical continuity interface (bonding and shielding)

The spacecraft is required to have a ground reference point close to the separation plane, on which a test socket can be mounted.

The resistance between the major structural metallic element of the spacecraft and a closest reference point on the structure shall be less than 10 m Ω .

More specifically, this rule can be interpreted as follows:

- The resistance between the spacecraft launch vehicle interface ring and the upper adapter shall be less than 10 m Ω for a current of at least 10 mA. The spacecraft structure in contact with the L/V (separation plane of the spacecraft rear frame or mating surface of a customer's adapter) shall not have any treatment or protective process applied which creates a resistance greater than 10 m Ω for a current of at least 10 mA between the spacecraft rear frame and the Ariane adapter upper frame.
- The resistance between some specific element of the spacecraft (such as screws, MLI for example) and a closest reference point on the structure could be up to 100 k Ω as far as they are not linked (connected) to the L/V.

5.5.4. RF communication link between spacecraft and the EGSE

A direct reception of RF emission from the spacecraft antenna can be provided until lift-off as an optional service requiring additional hardware installation on fairing or SYLDA 5 and on the launch pad. The following configurations are possible:

- Use of a passive repeater composed of 2 cavity back spiral antenna under the fairing or the SYLDA 5
- Use of radio-transparent windows in fairing

The fairing authorized location for radio-transparent windows and passive repeaters (SRP) are provided in Fig A6.1.

5.6. Interface verifications

5.6.1. Prior to the launch campaign

Prior to the initiation of the launch campaign, a mechanical and electrical fit-check may be performed. Specific L/V hardware for these tests is provided according to the clauses of the contract.

The objectives of this fit-check are to confirm that the spacecraft dimensional and mating parameters meet all relevant requirements as well as to verify operational accessibility to the interface and cable routing. It can be followed by a release test.

This test is usually performed at the customer's facilities, with the adapter equipped with its separation system and electrical connectors provided by Arianespace. For a recurrent mission the mechanical fit-check can be performed at the beginning of the launch campaign, in the payload preparation facilities.

5.6.2. Pre-launch validation of the electrical interface

5.6.2.1. Definition

The electrical interface between the spacecraft and the launch vehicle is validated on each phase of the launch preparation where its configuration is changed or the harnesses are reconnected. These successive tests ensure the correct integration of the spacecraft with the launcher and allow to proceed with the non reversible operations. There are two major configurations:

- Spacecraft mated to the adapter
- Spacecraft with adapter mated to the launcher

5.6.2.2. Spacecraft EGSE

The following Customer's EGSE will be used for the interface validation tests:

- OCOE, spacecraft test and monitoring equipment, permanently located in PPF Control rooms and linked with the spacecraft during preparation phases and launch even at other preparation facilities and launch pad.
- COTE, Specific front end Check-out Equipment, providing spacecraft monitoring and control, ground power supply and hazardous circuit's activation (SPM, ...). The COTE follows the spacecraft during preparation activity in PPF, HPF and BAF. During launch pad operation, the COTE is installed in the launch table. The spacecraft COTE is linked to the OCOE by data lines to allow remote control.
- Set of the ground cables for the spacecraft verification.

The installation interfaces as well as environmental characteristics for the COTE are described in the chapter 6.

The principles of spacecraft to EGSE connections all along the launch campaign are depicted in figures 5.6.2.2.a to 5.6.2.2.c.

Depending on COTE utilization requirements (necessity to charge batteries), two COTE's may be necessary. This will be analyzed on a case-by-case basis with the customer.

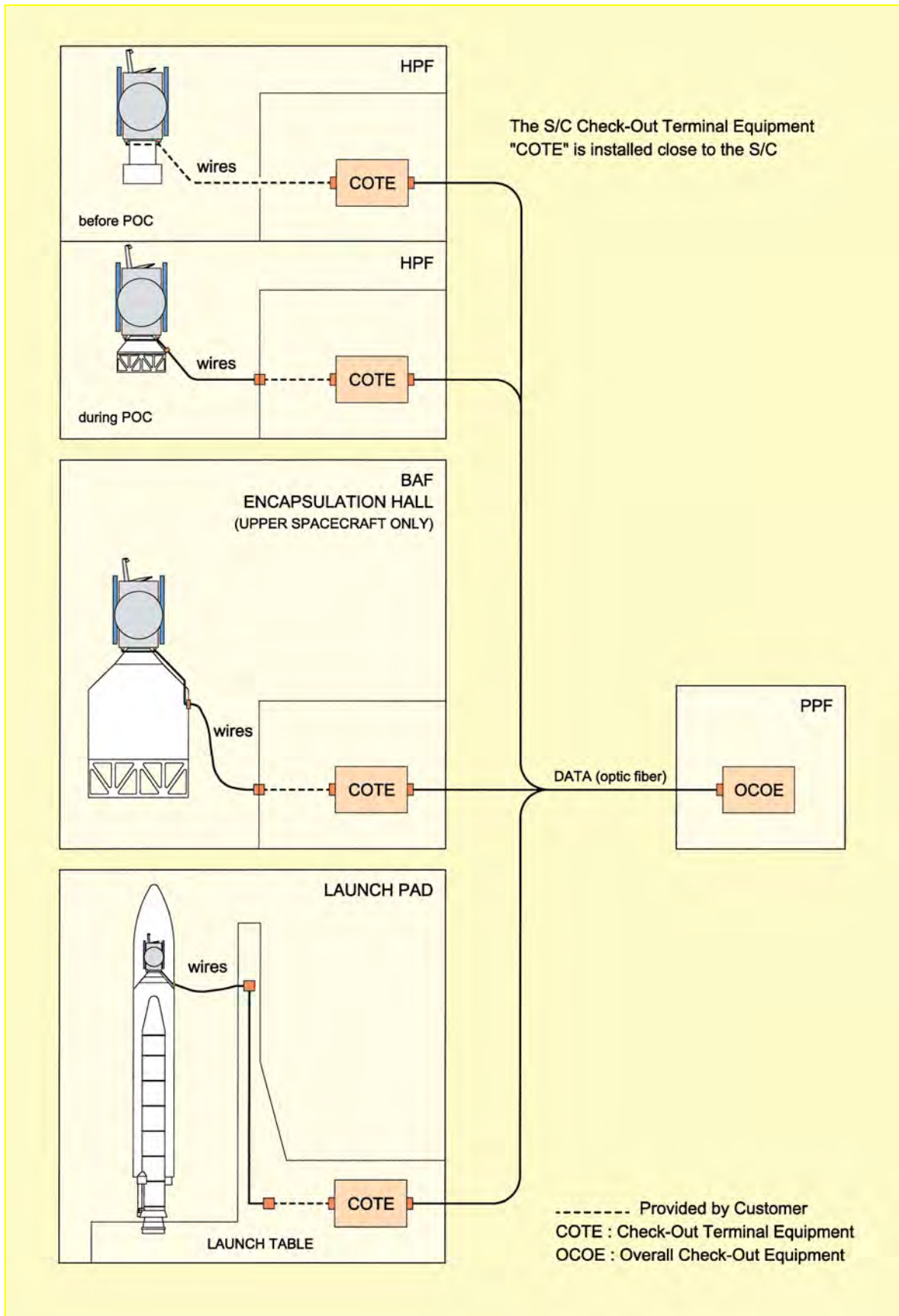

Figure 5.6.2.2.a – Spacecraft remote control configuration during campaign

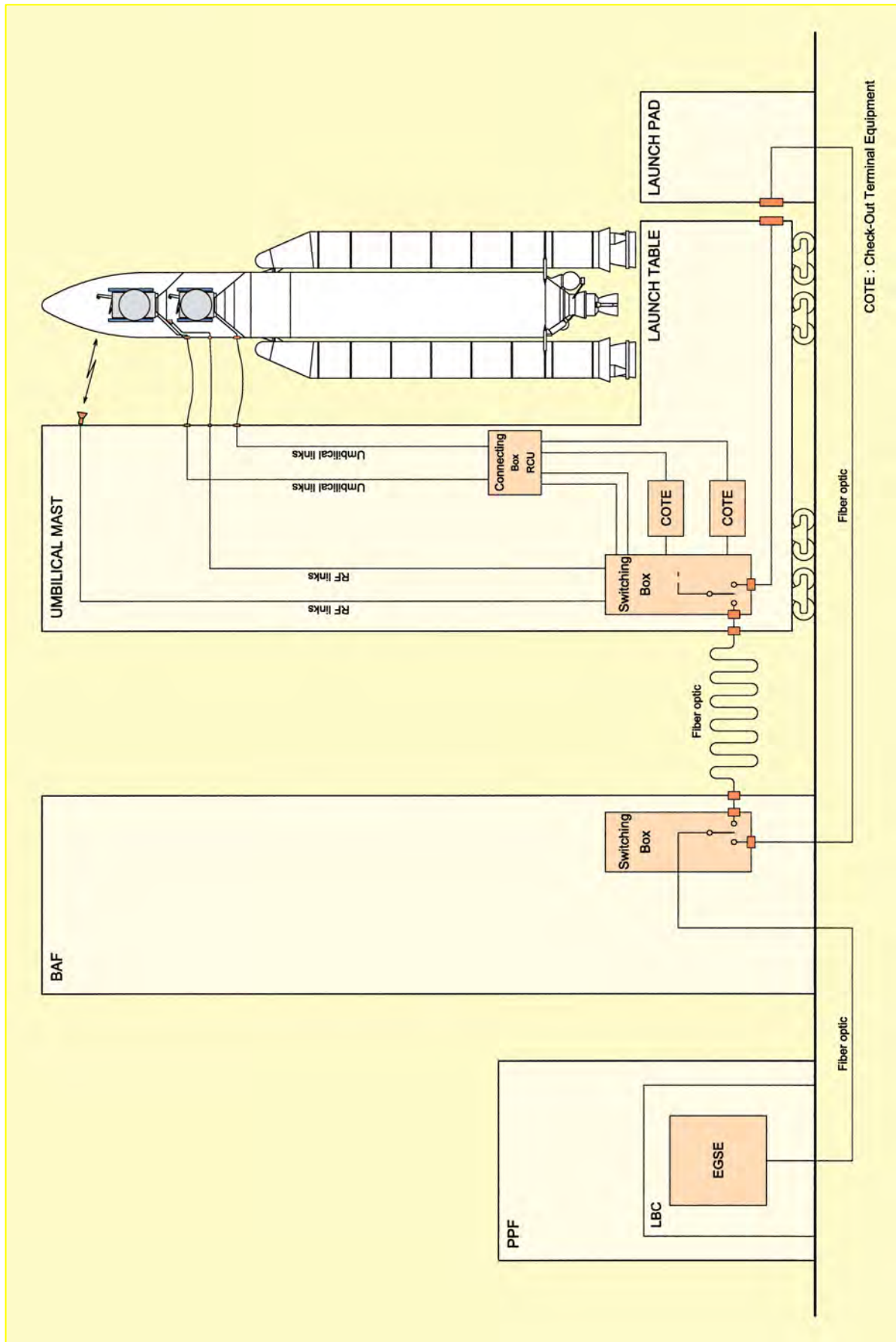

Figure 5.6.2.2.b – Principles of spacecraft interfaces during transfer

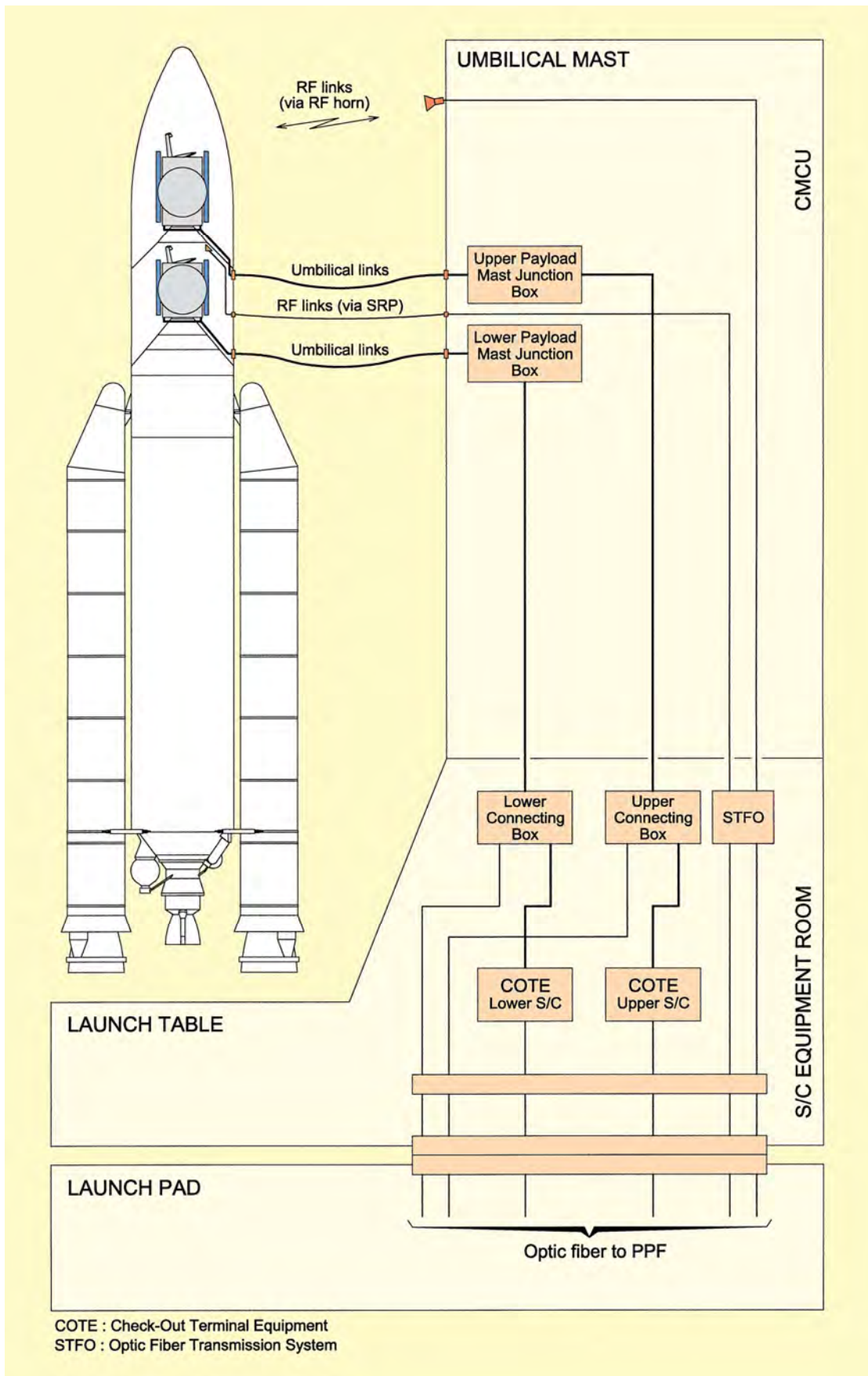

Figure 5.6.2.2.c – Principle of spacecraft / launch pad interfaces

Guiana Space Centre

Chapter 6

6.1. Introduction

6.1.1. French Guiana

The Guiana Space Centre is located in French Guiana, a French Overseas Department (D.O.M.). It lies on the Atlantic coast of the Northern part of South America, close to the equator, between the latitudes of 2° and of 6° North at the longitude of 50° West.

It is accessible by sea and air, served by international companies, on regular basis. There are flights every day from and to Paris, either direct or via the West Indies. Regular flights with North America are available via Guadeloupe or Martinique.

The administrative regulation and formal procedures are equivalent to the one applicable in France or European Community.

The climate is equatorial with a low daily temperature variation, and a high relative humidity.

The local time is UTC - 3 h.



Figure 6.1.1.a – The French Guiana on the map

6.1.2. The European spaceport

The European spaceport is located between the two towns of Kourou and Sinnamary and is operational since 1968.

The CSG is governed under an agreement between France and the European Space Agency and the day to day life of the CSG is managed by the French National Space Agency (Centre National d'Etudes Spatiales – CNES) on behalf of the European Space Agency.

The CSG mainly comprises:

- the **CSG arrival area** through the sea and air ports (managed by local administration);
- the **Payload Preparation Complex** (Ensemble de Preparation Charge Utile – EPCU) shared between three launch vehicles, where the spacecraft are processed,
- the **Upper Composite Integration Facility** dedicated to each launch vehicle: for Ariane 5, the upper composite integration is carried out in the **Final Assembly Building (BAF)**,
- the dedicated **Launch Sites** for Ariane, Soyuz and Vega each including Launch Pad, LV integration buildings, Launch Centre (CDL, "Centre De Lancement") and support buildings,
- the **Mission Control Centre** (MCC or CDC – "Centre De Contrôle").

The Ariane Launch Site (Ensemble de Lancement Ariane n°3 ELA3) is located approximately 15 km to the North-West of the CSG Technical Centre (near Kourou). The respective location of Ariane 5, Soyuz and Vega launch sites is shown in figure 6.1.2.a.

General information concerning French Guiana, European Spaceport, Guiana Space Centre (CSG) and General Organization are presented in the presentation of Satellite Campaign Organization, Operations and Processing

Buildings and associated facilities available for spacecraft autonomous preparation are described in the Payload Preparation Complex (EPCU) User's Manual.

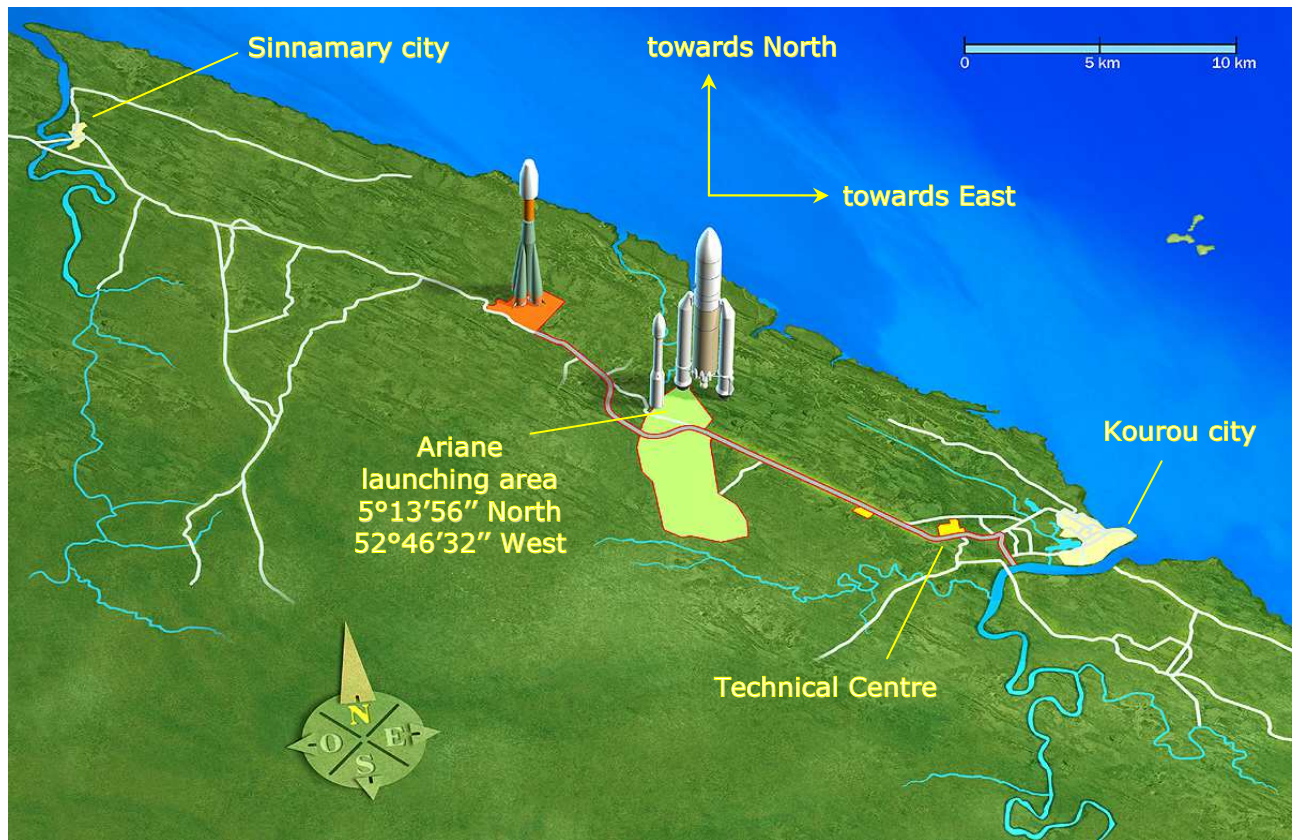

Figure 6.1.2.a – Map of the Guiana Space Centre

6.2. CSG general presentation

6.2.1. Arrival areas

The Spacecraft, Customer's ground support equipment and propellant can be delivered to the CSG by aircraft, landing at Félix Eboué international airport, and by ship at the Cayenne Dégrad-des-Cannes harbor. Arianespace provides all needed support for the equipment handling and transportation as well as formality procedures.

6.2.1.1. Félix Eboué international airport

Félix Eboué international airport is located near Cayenne, with a 3200 meters runway adapted to aircraft of all classes and particularly to the Jumbo-jets:

- Boeing 747,
- Airbus Beluga, and
- Antonov 124.



A wide range of horizontal and vertical handling equipment is used to unload and transfer standard type pallets/containers.

Small freight can be shipped by the regular Air France flight.

A dedicated Arianespace office is located in the airport to welcome all participants arriving for the launch campaign.

The airport is connected with the EPCU by road, about 75 kilometers away.

6.2.1.2. Cayenne harbor

Cayenne harbor is located in the south of the Cayenne peninsula in Dégrad-des-Cannes. The facilities handle large vessels with less than 6 meters draught.

The harbor facilities allow the container handling in Roll-On/Roll-Off (Ro-Ro) mode or in Load-On/Load-Off (Lo-Lo) mode. A safe open storable area is available at Dégrad-des-Cannes.

The port is linked to Kourou by 85 km road.



6.2.2. Payload preparation complex (EPCU)

The Payload Preparation Complex (EPCU) is used for spacecraft autonomous launch preparation activities up to integration with the launch vehicle and including spacecraft fuelling. The EPCU provides wide and redundant capability to conduct several simultaneous spacecraft preparations thanks to the facility options. The specific facility assignment is usually finalized one month before spacecraft arrival.

The Payload Preparation Complex consists of 3 major areas and each of them provides the following capabilities:

- **S1**, Payload Processing Facility (PPF) located at the CSG Technical Centre
- **S3**, Hazardous Processing Facilities (HPF) located close to the ELA3
- **S5**, Payload/Hazardous Processing Facilities (PPF/HPF)

The complex is completed by auxiliary facilities: the Propellant Storage Area (ZSE), the Pyrotechnic Storage Area (ZSP) and chemical analysis laboratories located near the different EPCU buildings.

All EPCU buildings are accessible by two-lane tarmac roads, with maneuvering areas for trailers and handling equipment.

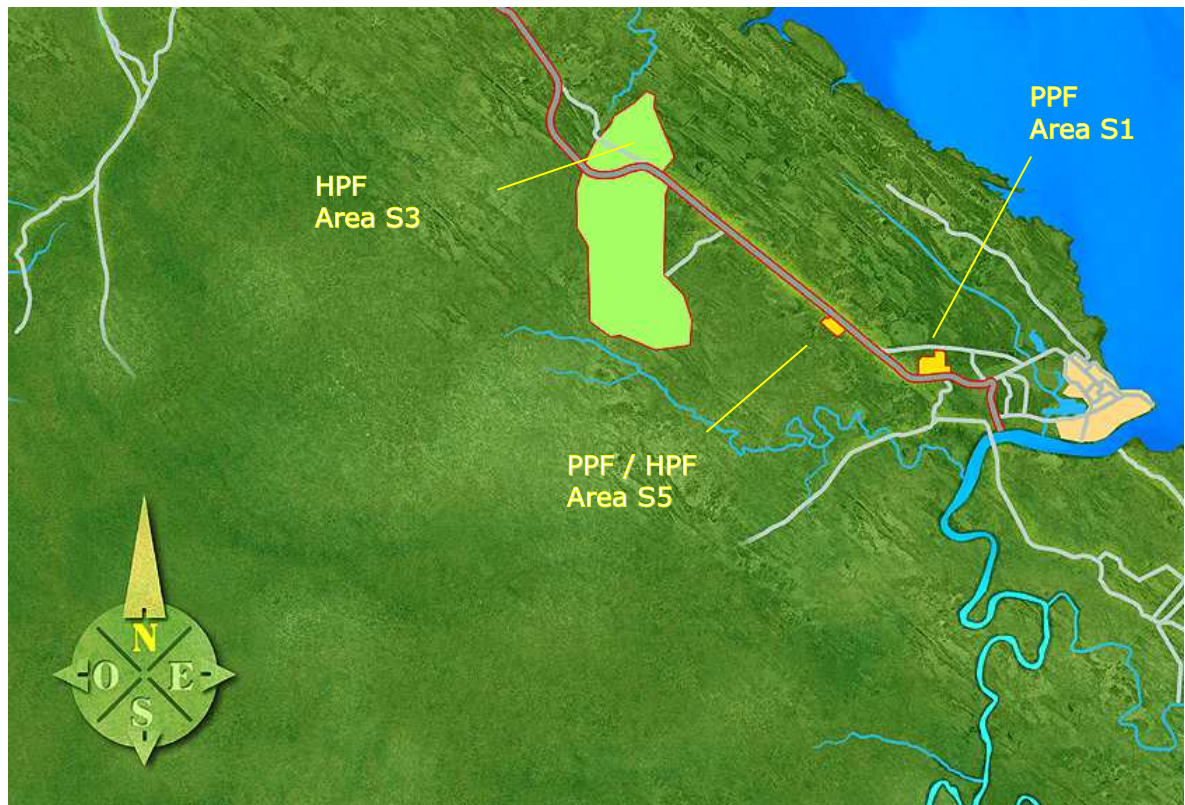

Figure 6.2.2.a – Payload preparation complex (EPCU) location

6.2.2.1. S1 Payload Processing Facility

The S1 Payload Processing Facility consists of buildings intended for simultaneous preparation of several spacecraft. It is located on the north of the CSG Technical Centre close to Kourou town. The area location, far from the launch pads, ensures unrestricted all-the-year-round access.

The area is completely dedicated to the customer launch teams and is used for all non-hazardous operations.

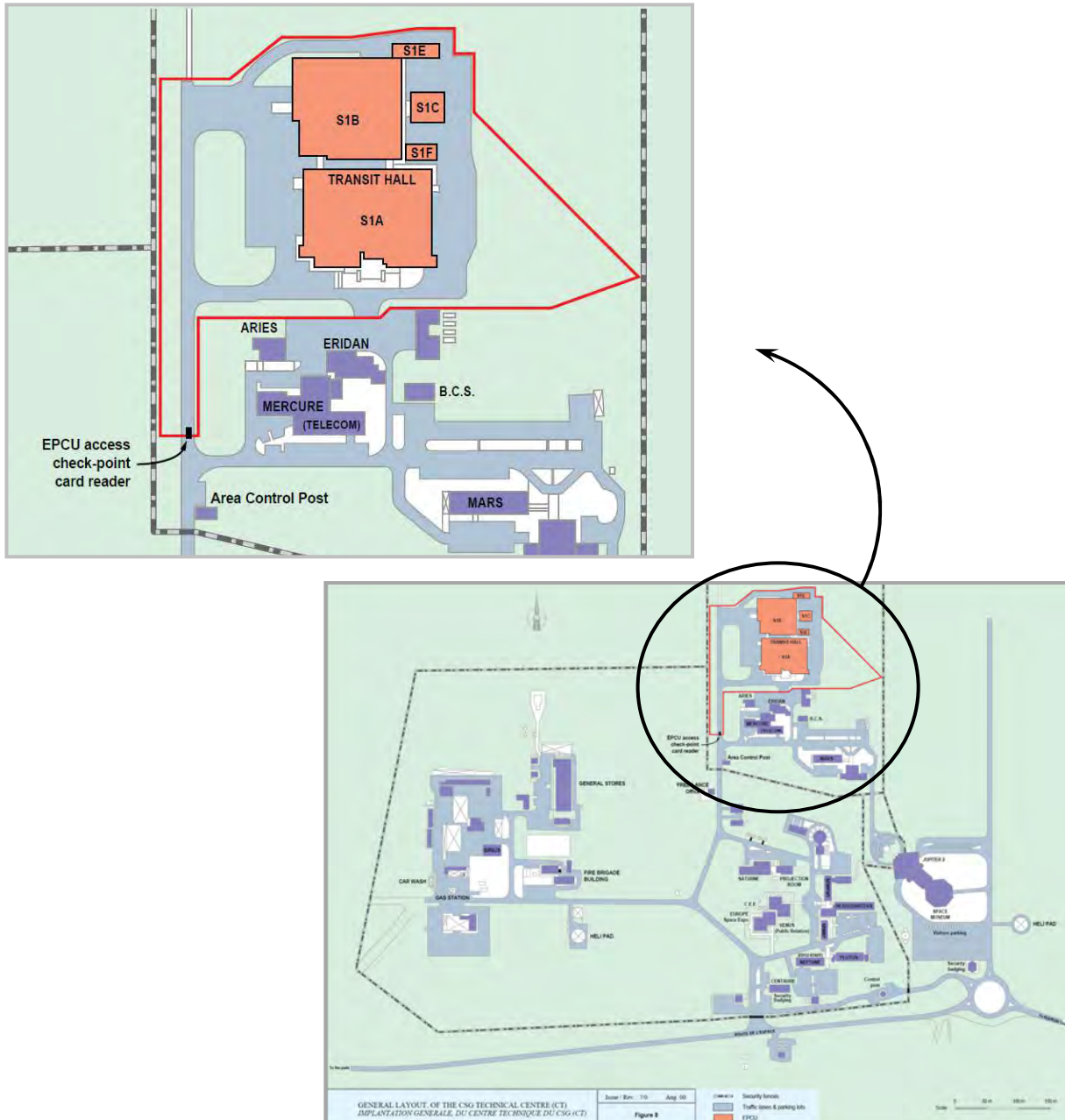

Figure 6.2.2.1.a - S1 area layout

The facility is composed of 2 similar main buildings comprising one clean room each, a separated building for offices and laboratory and storage areas. The passage between buildings is covered by a canopy for sheltered access between the buildings. The storage facility can be shared between buildings.



Figure 6.2.2.1.b – S1 area composition

The S1A building is composed of 1 clean high bay of 490 m², one control room, offices and storage areas.

The S1B building is composed of 1 clean high bay of 860 m² that could be shared by two spacecraft ("Northern" and "Southern" areas), 4 control rooms and storage areas. Offices are available for spacecraft teams and can accommodate around 30 people per SC Project.

The S1C, S1E and S1F buildings provide extension of the S1B office space. The standard offices layout allows to accommodate around 30 people per spacecraft Project.

The detailed building layouts are provided in EPCU user's manual.

6.2.2.2. S3 Hazardous Processing Facility

The S3 Hazardous Processing Facilities consist of buildings used for different hazardous operations. The area is located on the south-west of the Ariane-5 launch pad (ZL3), 15 km from the CSG Technical Centre. The area close location to the Ariane and Vega launch pads imposes precise planning of the activity conducted in the area.

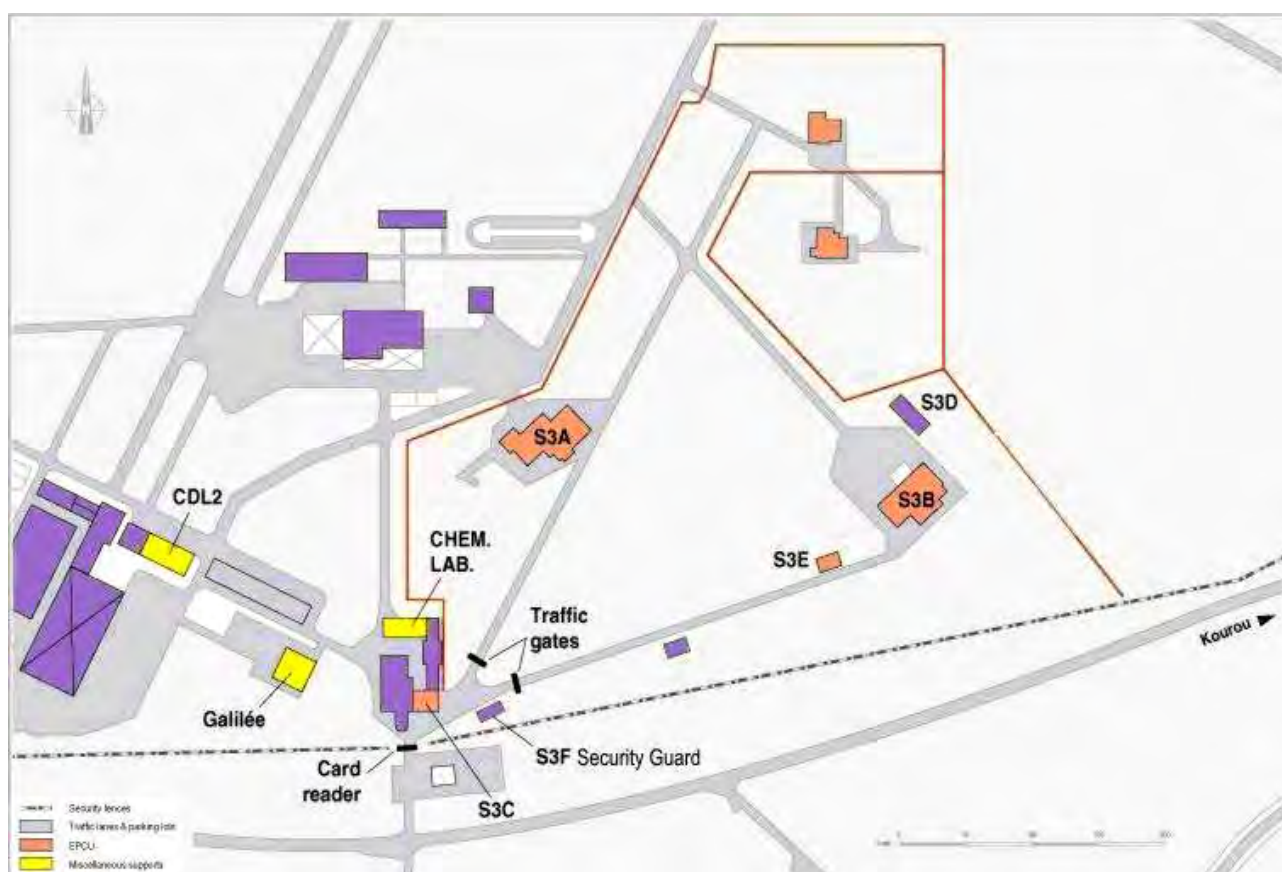

Figure 6.2.2.2.a – S3 area map



Figure 6.2.2.2.b – S3 area overview

The Customer's facility includes two separated buildings S3B and S3C.

The S3B building allows hazardous preparation of medium-class spacecraft: main tanks and attitude control system filling, weighing, pressurization and leakage tests as well as final spacecraft preparation and integration with adapter. The building is mainly composed of one filling hall (HR) of 330 m², and one encapsulation hall (HN, not used for AR5 launch campaign) of 414 m².

The S3C building is dedicated to the remote monitoring of the hazardous operations such as S/C filling (Safety control room).



Figure 6.2.2.2c – S3C building

The detailed building layouts are provided in EPCU user's manual.

6.2.2.3. S5 Payload Preparation & Hazardous Facility

The S5 Payload & Hazardous Processing Facility consists of clean rooms, fuelling rooms and offices connected by environmentally protected corridors. It is safely located on the south-west bank of the main CSG road, far from launch pads and other industrial sites providing all-the-year-round access.

EPCU S5 enables an entire autonomous preparation, from satellite arrival to fuelling, taking place on a single site. The building configuration allows for up to 4 spacecraft preparations simultaneously, including fuelling, and in the same time, provides easy, short and safe transfers between halls.



Figure 6.2.2.3.a– PPF/HPF S5 area overview

The main facility is composed of 3 areas equipped with airlocks and connected by two access corridors.

The S5C area, dedicated to the spacecraft non-hazardous processing and to house the Project team is mainly composed of 1 large high bay of 700 m² that can be divided in 2 clean bays, 4 control rooms and separated office areas.

The S5A area, dedicated to spacecraft fuelling and other spacecraft hazardous processing, is mainly composed of 1 clean high bay of 300 m².

The S5B area, dedicated to large spacecraft fuelling and other spacecraft hazardous processing, is mainly composed of 1 clean high bay of 410 m².

The halls, the access airlocks and the transfer corridors are compliant with ISO 8 cleanliness. The satellite is transported from one hall to another on Customer's air cushions or trolleys.

In addition to the main facility, the S5 area comprises the following buildings:

- **S5D** dedicated to final decontamination activities of satellite fuelling equipment
- **S5E** dedicated to the preparation of Scape suits and training, dressing and cleaning of propulsion teams

The entrance to the area is secured at the main access gate.

The detailed building layouts are provided in EPCU user's manual.

6.2.3. Facilities for combined and launch operations

6.2.3.1. Ariane launch site (ELA3 "Ensemble de Lancement Ariane n°3")

The ELA3 launch complex essentially comprises three facilities which are directly involved in satellite preparation activities. These are:

- the **Final Assembly Building (BAF)** in which satellite preparation final operations are conducted in conjunction with launcher elements (lower composite or upper composite, i.e. fairing and SYLDA 5).
- the **Launch Table** on which the launcher lower and upper composites are assembled, is used to transfer the launcher to the launch pad, and houses front-end equipment required for final check-out of the satellites.
- the **Launch Control Centre (CDL3)** is used for permanent monitoring of the launcher status all along the campaign up to the launch.

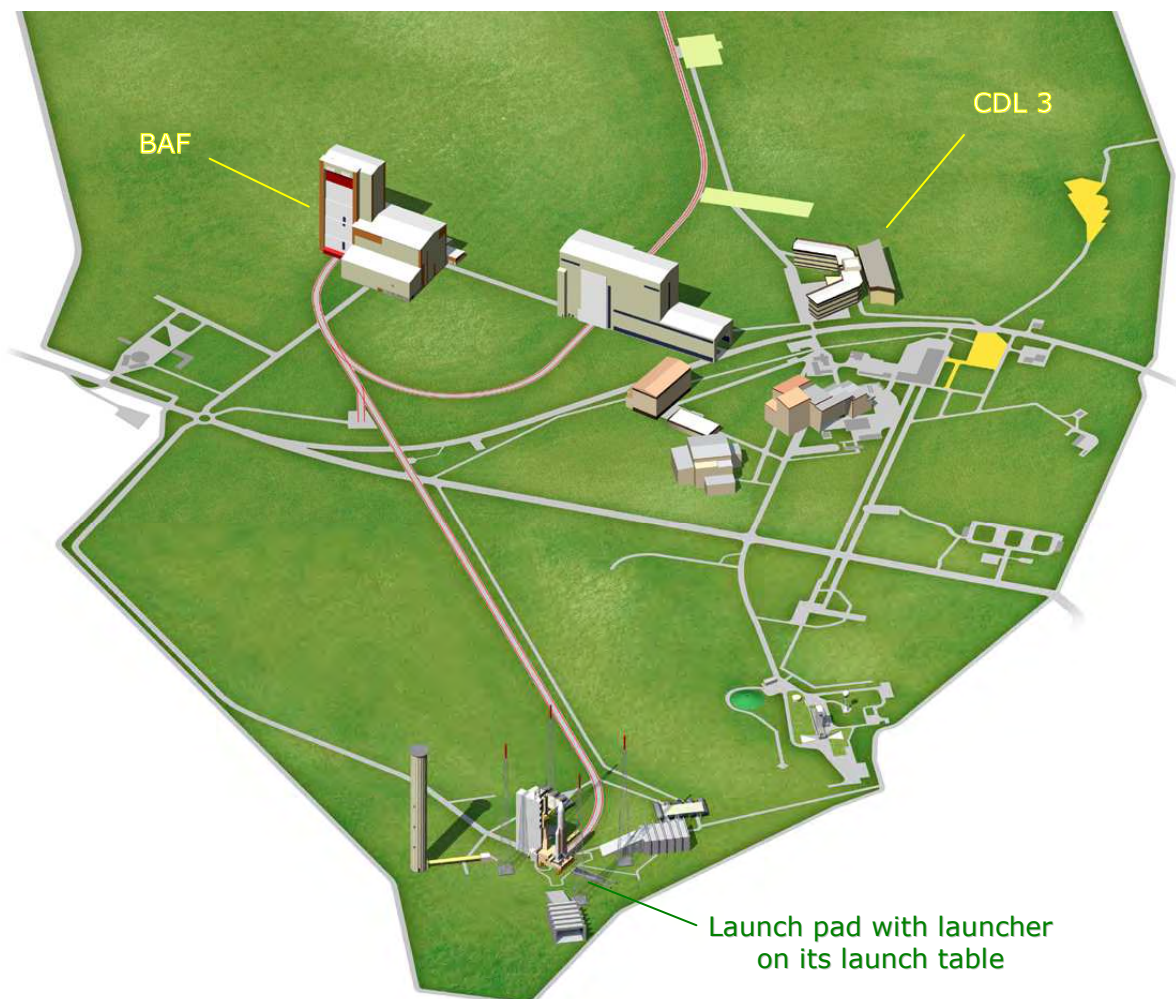

Figure 6.2.3.1.a – ELA3 overview

6.2.3.1.1 Final Assembly Building (BAF "Bâtiment d'Assemblage Final")

This building is used for final preparation of the lower composite (launcher on its table), integration of the upper composite, and assembly of the upper composite on the launcher.

This building is located approximately 2600 m to the south of the launch pad.

Satellite encapsulation hall is used for integration of the upper satellite: length 60 m, width 55 m and height 47 m.

It comprises:

- encapsulation clean hall measuring 40 x 30 m,
- COTE room for customers,
- airlock measuring 30 x 20 m, incorporating a shaft for transferring the spacecraft onto the launcher.

Launch Vehicle preparation hall which receives the launch table and launcher is used for integration of the upper composite (height 90 m).



Figure 6.2.3.1.1.a – BAF launch vehicle access side

6.2.3.1.2 Launch Table

The launch table (870 metric tons) is used to transfer the launcher during the various phases of its preparation: between the launcher integration building and the final assembly building, and between the final assembly building and the launch pad ZL3.

The table/launcher assembly includes a transfer ancillary services unit, comprising a number of mobile trailers carrying power packs, air-conditioning equipment and the optical fiber link deployment/winder unit ensuring permanent communication links between the SC and the LBC during the transfer.



Figure 6.2.3.1.2.a – Ariane 5 on launch table during transfer

A COTE room is designed to house ground/spacecraft remote interface equipment providing all spacecraft/check-out equipment functional links.

The COTE room in the launch table has the following main features:

- 4 slots for 19" anti-seismic racks are available for each Customer,
- COTE installation by vertical hoisting through a L= 1 m, w=0.8 m access opening in the floor (max weight 800 kg),
- personnel access through a 1730 x 1000 mm door,
- COTE removal with a dedicated Arianespace tool, requiring horizontal handling, through the personnel access door.

Details of anti-seismic racks installation and interfaces can be obtained from Arianespace. Up to 2 anti-seismic racks can be provided by Arianespace.

The equipments installed in the COTE are to be qualified either in acoustic or random with respect to the following levels:

- Acoustic

Octave bands (Hz)	31.5	63	125	250	500	1000	2000	Overall
Qualification level (dB)	133	132	128	126	123	122	118	137

Time duration: 1 minute

- Random

Bandwidth	Overall level (g eff)	PSD	Time duration
20 - 2000	12	0.0727	1 minute on 3 axes

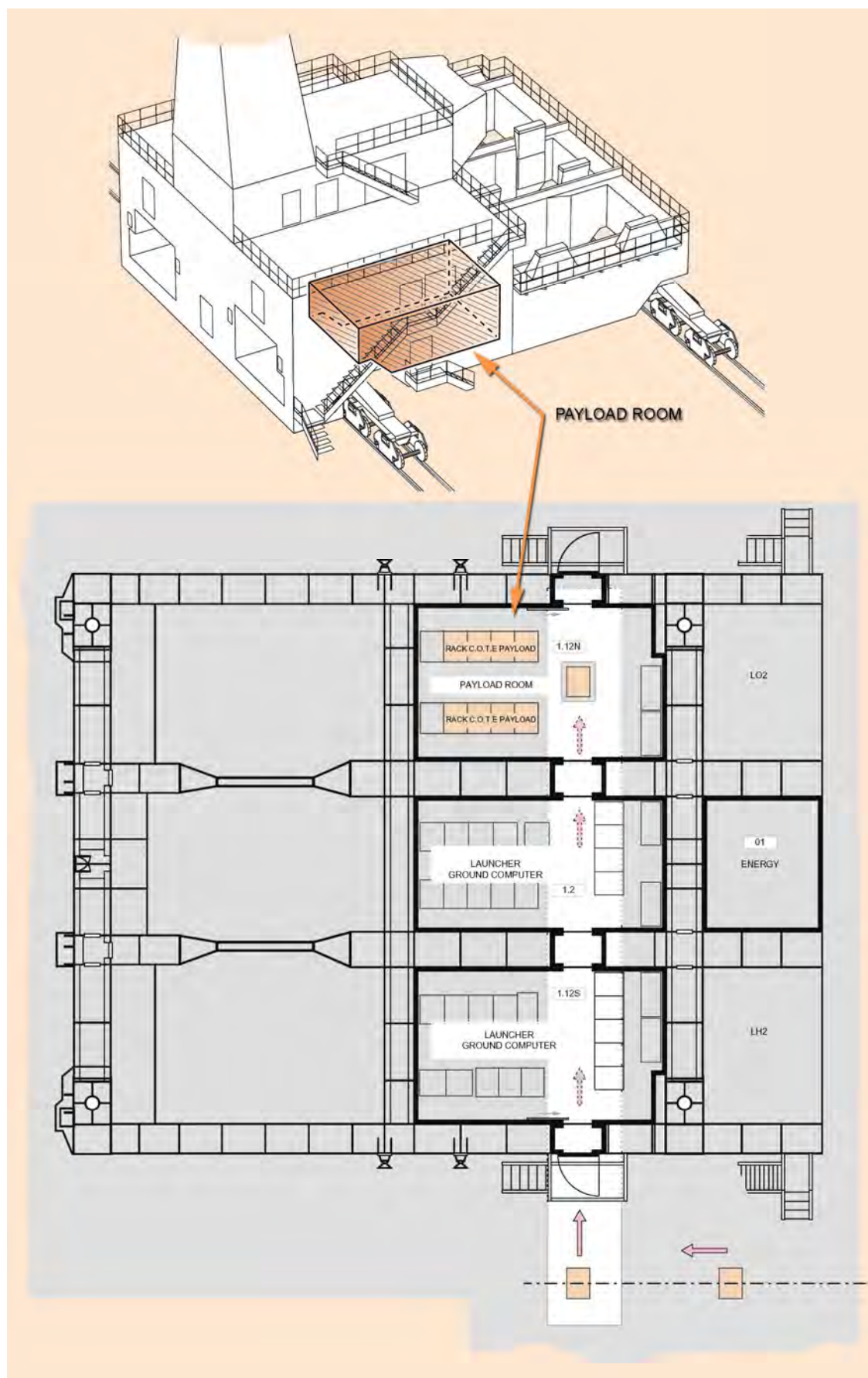

Figure 6.2.3.1.2.b – Payload room in Launch Table

6.2.3.1.3 Ariane Launch Pad (ZL3 "Zone de Lancement n°3")

The table and launcher are moved to the launch pad (ZL3) for the final preparation phase and countdown.

The launch pad comprises:

- foundation block on which the launch table is positioned,
- heavily reinforced structure and tower containing all fluid and cryogenic interface circuits,
- three separate jet deflectors (one for the EPC and one for each EAP),
- four lightning masts, making it possible to carry out final operations without being subject to any lightning constraints,
- water tower 90 m high, with a capacity of 1500 m³ providing with a flow rate of 20 m³/s for attenuation of the acoustic levels,
- hydrogen burn-off pool (310 m²),
- ancillary installations for LOX and LH₂ fuel tanks.



Figure 6.2.3.1.3.a – Ariane 5 on its launch table arriving on the launch pad

6.2.3.1.4 Launch Control Centre (CDL3 "Centre de Lancement n°3")

The Launch Control Centre comprises a reinforced concrete structure designed to absorb the energy of fragments of a launcher (weighing up to 10 metric tons).

This building is located approximately 2500 m from the launch pad ZL3.

The reinforced part of the structure has armored doors and an air-conditioning system with air regeneration plant. The interior of the Launch Control Centre is thus totally isolated from a possible contaminated external atmosphere.



Figure 6.2.3.1.4.a – Launch Control Centre overview

6.2.3.2. Mission Control Centre – Technical Centre

The main CSG administrative buildings and offices, including safety and security service, laboratories, CNES, ESA representative offices are located in the Technical Centre. Its location, a few kilometers from Kourou on the main road to the launch pads, provides the best conditions for management of all CSG activity.

Along with functional buildings the Technical Centre houses the Mission Control Centre located in the Jupiter building. The Mission Control Centre is used for:

- management and coordination of final pre-launch preparation and countdown,
- processing of the data from the ground telemetry network,
- processing of the readiness data from the launch support team (meteo, safety ...),
- providing data exchange and decisional process,
- flight monitoring.

The spacecraft launch manager or his representatives stay in the Mission Control Centre during pre-launch and launch activities and, if necessary, can call a hold which may stop the countdown.

The Customer will have up to 3 operator's seats in the operational area, and 2 other seats for other Customer's representatives area.

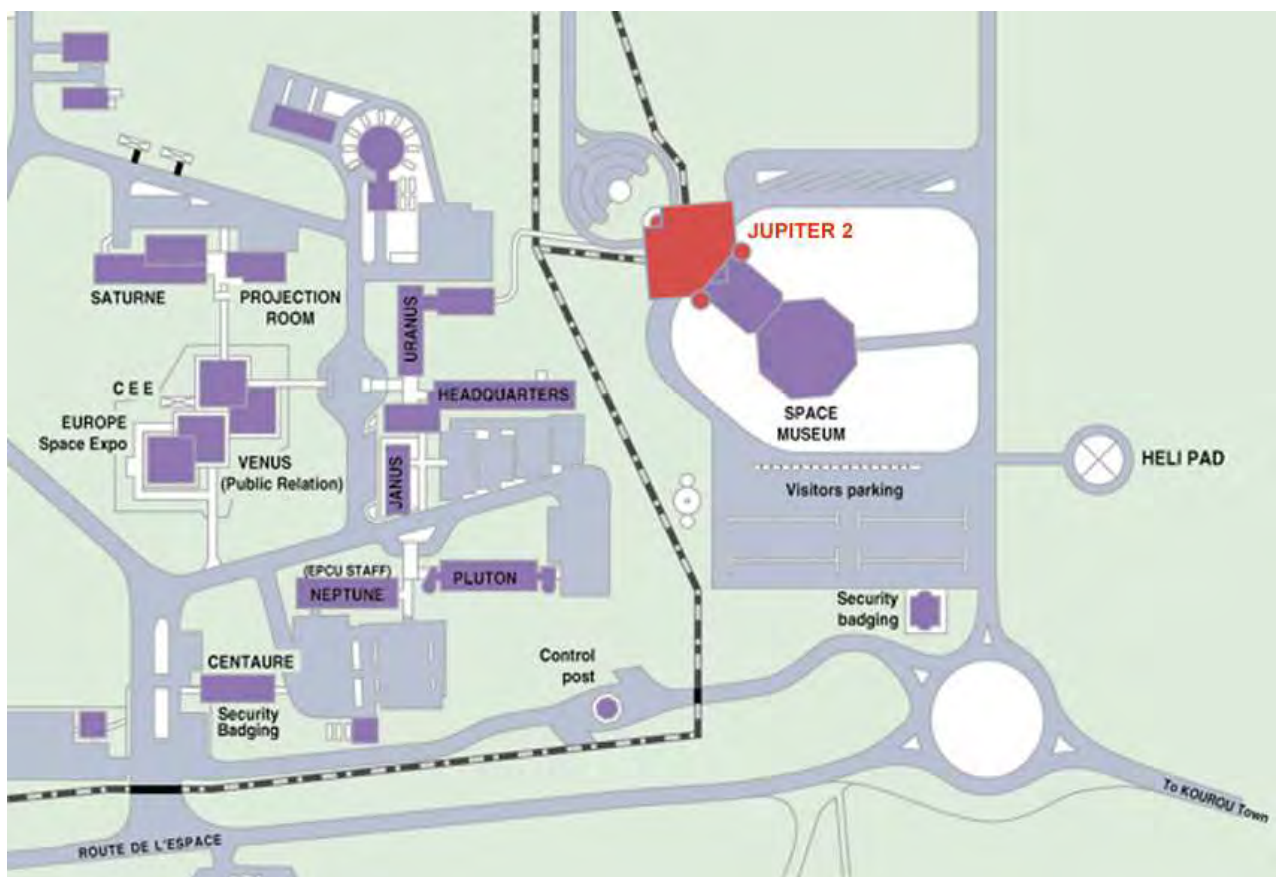

Figure 6.2.3.2.a – Location of Mission Control Centre in Technical Centre



Figure 6.2.3.2.b – Typical Mission Control Centre (Jupiter 2) lay out

6.3. CSG General characteristics

6.3.1. Environmental Conditions

6.3.1.1. Climatic conditions

The outside climatic conditions at the Guyana Space Centre are defined as follows:

- the ambient air temperature varies between $18^{\circ}\text{C} \leq T \leq 35^{\circ}\text{C}$
- the relative humidity varies between $60\% \leq \text{HR} \leq 100\%$.

6.3.1.2. Temperature, humidity and cleanliness in the facilities

Data related to the environment and cleanliness of the various working areas are given in table 3.3.2.2.a for S/C environment on ground and in EPCU user's manual for other facilities.

6.3.1.3. Mechanical Environment

No specific mechanical requirements are applicable during the activity at the CSG except during transportation and handling.

During transport by trucks and handling of the non-flight hardware and support equipment as well as spacecraft in its container, the following dimensioning loads at the interface with platform shall be taken into account:

- Longitudinal QSL (direction of motion) $\pm 1g$
- Vertical QSL (with respect to the Earth) $1g \pm 1g$
- Transverse QSL $\pm 1g$

Details on the mechanical environment of the spacecraft when it is removed from its container are given in chapter 3.

6.3.2. Power Supply

Category I is the Public Power Network.

Category II the CSG generators power network, it is an automatic back-up in case of Category I failure. In case of switch from Cat I to Cat II, the interruption lasts less than one minute.

Category III is the uninterruptible Power Supply Network available in LBCs and COTE rooms. Category III is used for critical equipment like S/C EGSE, communication, safety circuits, etc.

The CSG equipment can supply current of European standard (230 V / 400 V - 50 Hz) or US standard (120 V / 208 V - 60 Hz).

More detailed characteristics of the power network are presented in the EPCU User's Manual.

6.3.3. Communications network

6.3.3.1. Operational data network

Data links are provided between the customer support equipment located in the different facilities and the spacecraft during preparation and countdown. The customer EGSE located in the PPF Control room (LBC) is connected with the satellite through the COTE in the HPF, BAF and Launch Table customer room.

Customer data transfer is managed through links based on optical fiber links. Four main dedicated subsystems and associated protected networks are available.

STFO ("Système de Transmission par Fibres Optiques")

Transmission of TM/TC between customer's EGSE located in LBC and satellite or COTE can be performed as follows:

- RF signals in S, C, Ku and Ka (optional) frequency band
- Base band digital or analog

ROMULUS ("Réseau Opérationnel MULTiservice à Usage Spatial)

Transmission of operational signals between customer EGSE located in LBC and COTE

- Point-to-point links based on V24 circuits
- Point-to-point links based on V11 circuits

PLANET (Payload Local Area NETWORK)

PLANET provides customer with dedicated Ethernet VLAN (10 Mb/s minimum bitrate guaranteed with 100Mb/s link configuration possible). This network is set-up and managed by CSG: it can be accommodated according to customer's request for operational data transfer between EGSE's and/or for non operational links inter-offices connections between personal computers.

BARE FIBERS

Dedicated stripped ends optical fibers are also available in LBC for EGSE connectors at one end, in HPF and in the launch table Customer room for COTE connection at the other end.

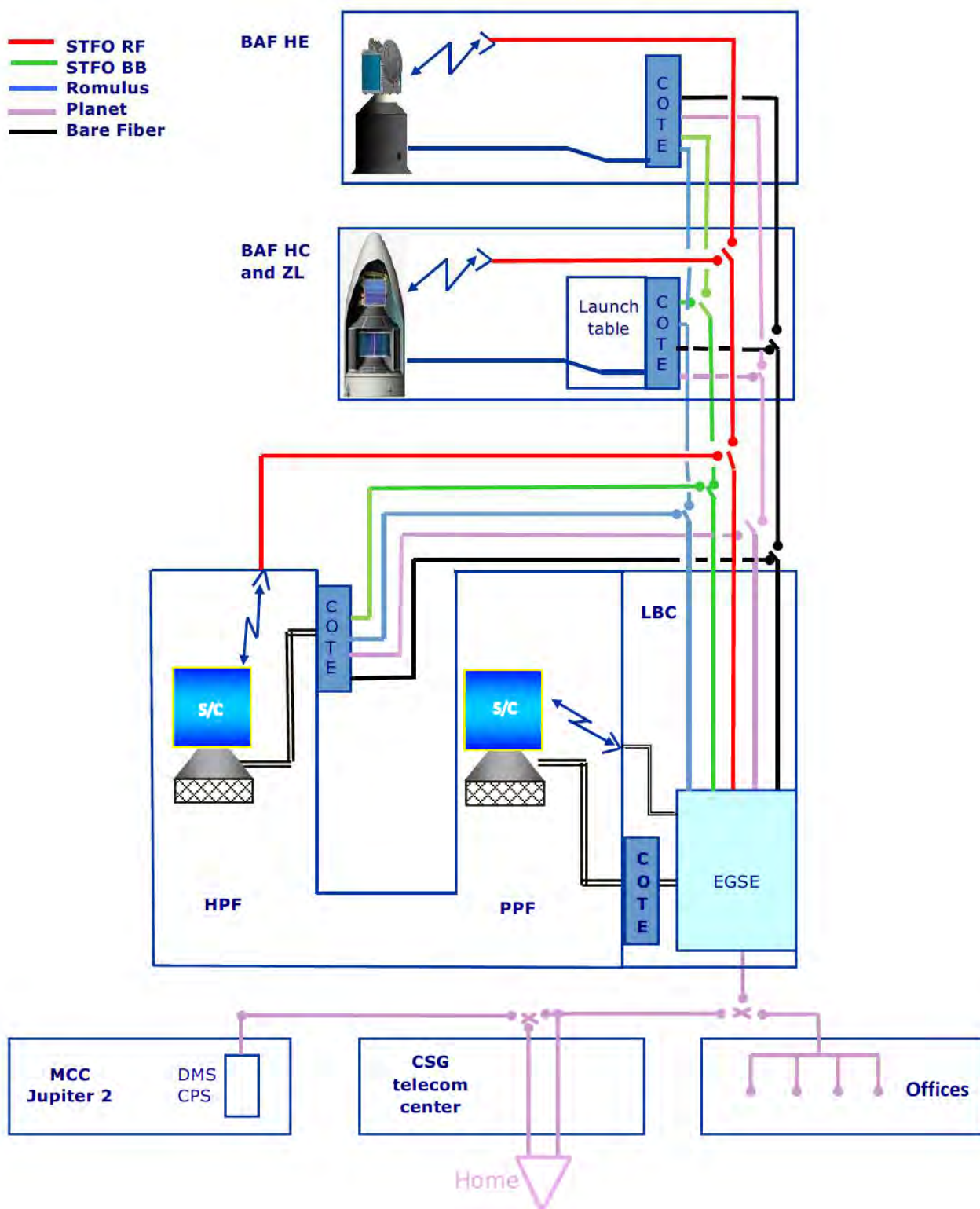

Figure 6.3.3.1.a – Typical data network configuration

6.3.3.2. Range communication network

The multifunctional range communication network provides customer with different ways to communicate internally at CSG, and externally, by voice and data, and delivers information in support of satellite preparation and launch.

The following services are proposed in their standard configuration or adapted to the customer needs:

CSG Telephone PABX System (CTS)

Arianespace provides telephone sets, fax equipment and also ISDN access for voice and data transmission through the CSG local phone network with PABX Commutation Unit.

Public external network

The CSG Telephone System (CTS) is commutated with external public network of France Telecom including long-distance paid, ISDN calls opportunities and access.

The GSM system cellular phones are operational at CSG through public operator providing roaming with major international operator.

Direct or CSG PABX relayed external connection

- Connection to long distance leased lines (LL)

The customer could subscribe at external provider for the Long Distance Leased lines or satellite-based communication lines. These lines will be connected to the CSG PABX Commutation Unit or routed directly to the Customer equipment. For satellite-based communication lines, antennae and decoder equipment are supplied by customer.

- PABX relay lines connection (LIA)

On customer request, long distance leased lines or satellite-based communication lines could be relayed with other PABX communication network providing permanent and immediate exchange between two local communication systems.

- Connection to point-to-point external data lines

In addition to long distance phone leased lines, the customer may extend the subscription for lines adapted to the data transmission. They could be connected to the CSG PABX through specific terminal equipment or to the LAN.

CSG Point-to-Point Telephone System (TS)

A restricted point-to-point telephone network (TS) can be used mainly during countdown exclusively by customer appointed operational specialists. This network is modular and can be adapted for specific customer request. These telephone sets can only call and be called by the same type of dedicated telephone sets.

Intercommunication system (Intercom)

- Operational intersite Intercom system (IO)

The operational communication during satellite preparation and launch is provided by independent Intercom system with a host at each EPCU facility and in BAF. This system allows full-duplex conversations between fixed stations in various facilities, conference and listening mode, and switch to the VHF/UHF fuelling network (IE). All communications on this network are recorded during countdown.

- Dedicated Intercom for hazardous operations (IE)

This restricted independent full-duplex radio system is available between operator's escape suits and control rooms for specific hazardous operations such as fuelling. On request this system could be connected to the Operational Intercom (IO).

VHF/UHF Communication system

The CSG facilities are equipped with a VHF/UHF network that allows individual handsets to be used for point-to-point mobile connections by voice.

Paging system

CSG facilities are equipped with a paging system. Beepers are provided to the customers during their campaign. When on duty, customer representative must be contactable by beeper 7/24.

Videoconference communication system

Access to the CSG videoconference studio, located in the S1B EPCU area, is available upon customer specific request.

6.3.3.3. Range information systems**Time distribution network**

The Universal Time (UT) and the Countdown Time (TD) signals are distributed to the CSG facilities from two redundant rubidium master clocks to enable the synchronization of the check-out operations. The time coding is IRIG B standard accessed through BNC connectors.

Operational reporting network (CRE)

The Reporting System is used to handle all green/red status generated during final countdown.

Closed-circuit television network (CCTV)

The PPF and HPF are equipped with internal closed-circuit TV network for monitoring and safety activities. CCTV is distributed to safety control rooms. The safety video images are also distributed in customer offices. Hazardous operations such as fuelling are recorded.

Public one-way announcement system

The public one-way announcement system ensures emergency announcement, alarms or messages to dedicated CSG locations.

This system is activated through the console of a site manager and safety control rooms.

6.3.4. Transportation and Handling

For all intersite transportation including transportation from the port of arrival of spacecraft and support equipment, CSG provides a wide range of road trailers, trolleys and trucks. These means are adapted to the various freight categories: standard, hazardous, fragile, oversized loads, low speed drive, etc.

The spacecraft is transported either:

- inside its container on the open road trailer,
- in the dedicated payload containers CCU ("Conteneur Charge Utile") mainly between PPF, HPF and BAF,
- encapsulated inside the launch vehicle upper composite between the BAF and the Launch Pad.

The payload containers CCU ensure transportation with low mechanical loads and maintains environments equivalent to those of clean rooms. Two containers are available:

- CCU2 and
- CCU3.

Full description of these containers can be found in the EPCU User's Manual. The choice of the container will be defined in the Interface Control Document considering the spacecraft actual mass and size provided by the customer.

Handling equipment including traveling cranes and trolleys needed for spacecraft and its support equipment transfers inside the building, are available and their characteristics are also described in the EPCU User's Manual. Spacecraft handling equipment is provided by the customer (refer to paragraph 4.2.4.3).



Figure 6.3.4.a – The CCU3 and CCU2 payload containers

6.3.5. Fluids and gases

Arianespace provides the following standard fluids and gases to support the customer launch campaign operations:

- industrial quality gases:
 - compressed air supplied through distribution network
 - N50 grade nitrogen (GN₂), supplied through distribution network (from tanks) or in 50 l bottles
 - N30 grade nitrogen (GN₂) supplied through distribution network only in S3 area
 - N55 grade helium (GHe), supplied through distribution network from tanks (limited capacity) or in 50 l bottles
- industrial quality liquids:
 - N30 grade nitrogen (LN₂) supplied in 35 or 60 l Dewar flasks
 - isopropyl alcohol (IPA)
 - de-mineralized water

Additionally, breathable-air and distilled-water networks are available in the HPF for hazardous operations.

Any gases and liquids different from the standard fluid delivery (different fluid specification or specific use: GN₂-N60, de-ionized water ...) can be procured. The customer is invited to contact Arianespace for their availability.

The CSG is equipped with laboratories for chemical analysis of fluids and gases. This service can be requested by the customer as an option.

Arianespace does not supply propellants. Propellant analyses, can be performed on request.

Disposal of chemical products and propellants are not authorized at CSG and wastes must be brought back by the customer.

6.4. CSG Operations policy

6.4.1. CSG planning constraints

Normal working hours at the CSG are based on 2 shifts of 8 hours per day, between 6:00 am and 10:00 pm from Monday to Saturday.

Work shifts out of normal working hours, Sunday or Public Holiday can be arranged on a case-by-case basis with advance notice and is subject to negotiations and agreement of CSG Authorities. No activities should be scheduled on Sunday and public holiday. In all cases, access to the facility is possible 24 hours a day, 7 days a week, with the following restrictions, mainly due to safety reasons:

- Advanced notice
- No hazardous operation or external hazardous constraints
- No changes to the facilities configuration
- Use of cranes and other handling equipment only by certified personnel

no requirement for range support After spacecraft processing and transfer to other facilities and with advance notice from Arianespace, the PPF may be used by another spacecraft. The spacecraft equipment shall be evacuated from the PPF clean room 24 hours after spacecraft departure.

The CSG is equipped with different storage facilities that can be used for the temporary equipment storage during the campaign, and, optionally, outside the campaign.

6.4.2. Security

The French Government, CSG Authorities and Arianespace maintain strict security measures that are compliant with the most rigorous international and national agreements and requirements. They are applicable to the three launch systems Ariane, Soyuz and Vega and allow strictly limited access to the spacecraft.

The security management is also compliant with the US DOD requirements for the export of US manufactured satellites or parts, and has been audited through a compliance survey by American Authorities (e.g. in frame of ITAR rules).

The security measures include:

- restricted access to the CSG at the road entrance with each area guarded by the Security service,
- escort for the satellite transportation to and within the CSG,
- full control of the access to the satellite: access to the facilities used for spacecraft preparation is limited to authorized personnel only through a dedicated electronic card system; the clean rooms are monitored 24 hours a day and 7 days a week by a security dedicated CCTV system with recording capability.

Security procedures can be adapted to the specific missions according to the Customer's requirements.

6.4.3. Safety

The CSG safety division is responsible for the application of the CSG Safety Rules during the campaign: this includes authorization to use equipment, operator certification, and permanent operation monitoring.

All CSG facilities are equipped with safety equipment and first aid kits. Standard equipment for various operations like safety belts, gloves, shoes, gas masks, oxygen detection devices, propellant leak detectors, etc... are provided by Arianespace. On request from the customer, CSG can provide specific items of protection for members of the spacecraft team.

During hazardous operations, a specific safety organization is activated (officers, equipment, fire brigade, etc.).

Any activity involving a potential source of danger is to be reported to CSG, which in return takes all actions necessary to provide and operate adequate collective protection equipment, and to activate the emergency facilities.

The spacecraft design and spacecraft operations compatibility with CSG safety rules is verified according with mission procedure described in the chapter 7.

6.4.4. Training course

In order to use the CSG facilities in a safe way, Arianespace will provide general training courses for the customer team. In addition, training courses for program-specific needs (e.g., safety, propellant team, crane and handling equipment operations, and communication means) will be given to appointed operators.

6.4.5. Customer assistance

6.4.5.1. Visas and access authorization

For entry to French Guiana, the Customer will be required to obtain entry permits according to the French rules.

Arianespace may provide support to address special requests to the French administration as needed.

The access badges to the CSG facility will be provided by Arianespace according to customer request.

6.4.5.2. Customs clearance

The satellites and associated equipment are imported into French Guiana on a temporary basis, with exemption of duties. By addressing the equipment to CSG with attention of Arianespace, the customer benefits from the adapted transit procedure (fast customs clearance) and does not have to pay a deposit, in accordance with the terms agreed by the customs authorities.

However, if, after a campaign, part of the equipment remains definitively in French Guiana, it will be subject to payment of applicable local taxes.

Arianespace will support the customer in obtaining customs clearances at all ports of entry and exit as required.

Moreover, CSG will insure all required controls to certify that equipment leaving French Guiana at the end of the campaign is explosive free, in order to prepare verifications at departure by airport authorities ("registered charger").

6.4.5.3. Personnel transportation

Customers have access to public rental companies located at Félix Eboué airport or through the assistance of Arianespace's affiliated company Free-Lance. Arianespace provides the transportation from and to Félix Eboué airport, and Kourou, at arrival and departure, as part of the General Range Support.

6.4.5.4. Medical care

The CSG is fully equipped to give first medical support on the spot with first aid kits, infirmary and ambulance. Moreover public hospitals with very complete and up-to-date equipment are available in Kourou and Cayenne.

The customer team shall take some medical precautions before the launch campaign: the yellow fever vaccination is mandatory for any stay in French Guiana.

6.4.5.5. VIP accommodation

Arianespace may assign some places for customer's VIP in the Mission Control Centre (Jupiter 2) for witnessing of the final chronology and launch. The details of this VIP accommodation shall be agreed with advance notice.

6.4.5.6. Other assistance

For the team accommodation, flight reservations, banking, off duty & leisure activities, the customer can use the public services in Kourou and Cayenne or can benefit from the support of Arianespace's affiliated company Free-Lance Services.

Mission integration and management

Chapter 7

7.1. Introduction

To provide the customer with smooth launch preparation and on-time reliable launch, a customer oriented mission integration and management process is implemented.

This process has been perfected through more than 350 missions and complies with the rigorous requirements settled by Arianespace, and with the international quality standards ISO 9001: V2008 specifications.

The mission integration and management process covers:

- **Mission management** and Mission integration schedule
- **L/V procurement** and hardware/software adaptation as needed
- **Systems engineering support**
- **Launch campaign management**
- **Safety assurance**
- **Quality assurance**

The mission integration and management process is consolidated through the mission documentation and revised during formal meetings and reviews.

7.2. Mission management

7.2.1. Contract organization

The contractual commitments between the Launch Service provider and the customer are defined in the **Launch Services Agreement (LSA)** with its **Statement of Work (SOW)** and its **Technical Specification**.

Based on the Application to Use Arianespace's Launch Vehicles (DUA "Demande d'Utilisation Arianespace"), filled out by the customer, the Statement of Work identifies the tasks and deliveries of the parties, and the Technical Specification identifies the technical interfaces and requirements.

At the LSA signature, an Arianespace Program Director is appointed to be the single point of contact with the customer. He/She is in charge of all aspects of the mission including technical and financial matters. The Program Director, through the Arianespace organization, handles the company's schedule obligation, establishes the program priority and implements the high-level decisions. At the same time, he/she has full access to the company's technical staff and industrial suppliers. He/She is in charge of the information and data exchange, preparation and approval of the documents, organization of the reviews and meetings.

During the launch campaign, the Program Director delegates his technical interface functions to the Mission Director for all activities conducted at the CSG. An operational link is established between the Program Director and the Mission Director.

Besides the meetings and reviews described hereafter, Arianespace will meet the customer when required to discuss technical, contractual or management items. The following main principles apply for these meetings:

- the dates, location, and agenda will be defined in advance by the respective Program Directors and by mutual agreement,
- the host will be responsible for the meeting organization and access clearance,
- the participation will be open for both side subcontractors and third companies by mutual preliminary agreement.

7.2.2. Mission integration schedule

The mission integration schedule will be established in compliance with the milestones and launch date specified in the Statement of Work of the Launch Service Agreement. The mission schedule reflects the time line of the main tasks described in detail in the following paragraphs.

A typical schedule for non-recurrent missions is based on a 24-month timeline as shown in figure 7.2.2.a. This planning can be reduced for recurrent spacecraft, taking into account the heritage of previous similar flights, or in case of the existence of a compatibility agreement between the spacecraft platform and the launch system.

For a spacecraft compatible of more than one launch system, the time when the launch vehicle (type and configuration) will be assigned to the spacecraft, will be established according to the LSA provisions.

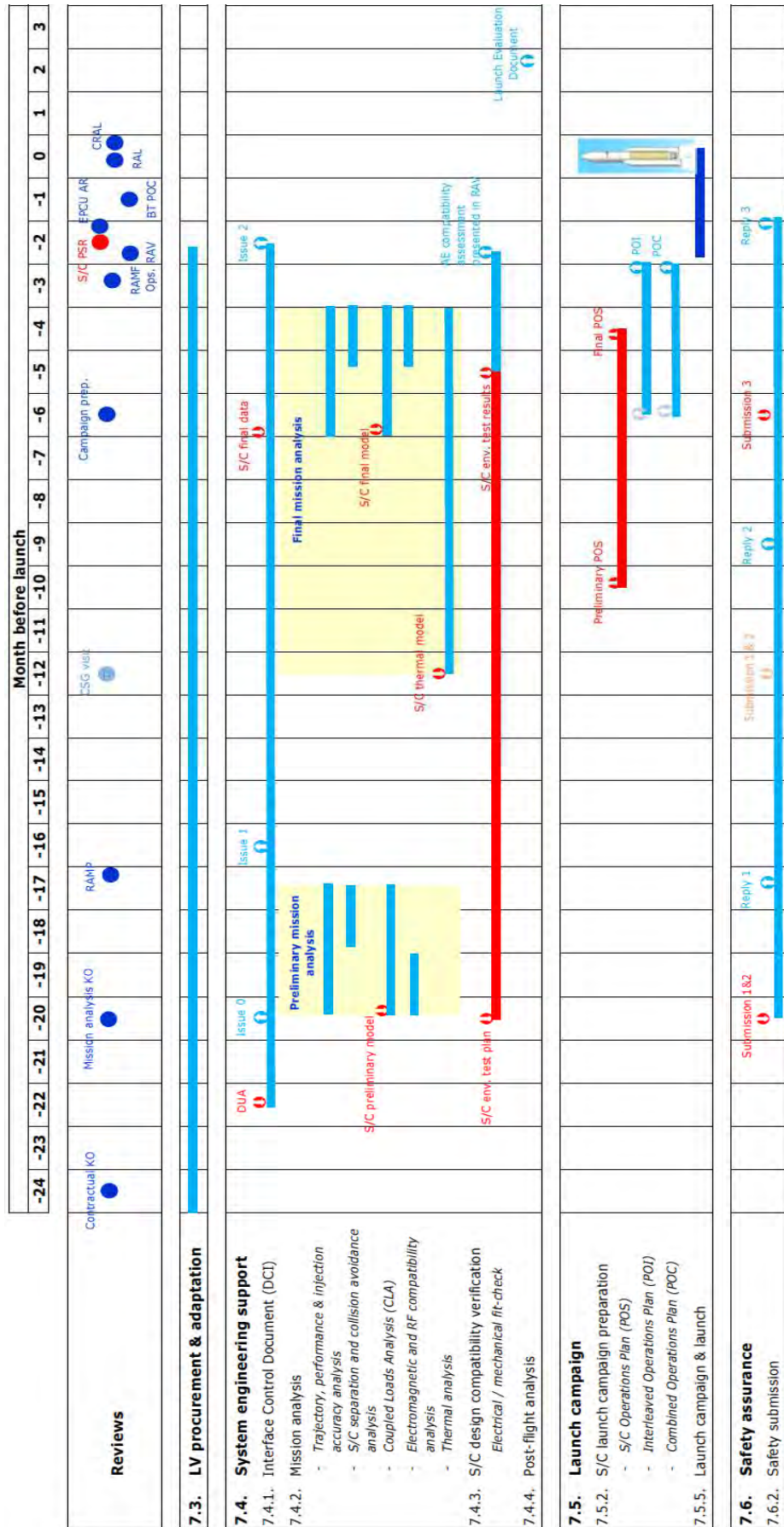

Figure 7.2.2.a - Typical mission integration schedule

7.3. Launch vehicle procurement and adaptation

7.3.1. Procurement/Adaptation process

Arianespace ensures the procurement of L/V hardware according to its industrial organization procedures. The following flight items will be available for the customer launch:

- One equipped launch vehicle and its propellants,
- Dedicated flight program(s),
- One standard fairing with optional access doors and optional passive repeaters or radio-transparent windows,
- One adapter with its separation system(s), umbilical harnesses, and instrumentation,
- Mission dedicated interface items (connectors, cables and others),
- Mission logo on the L/V from customer artwork supplied not later than 6 months before launch.

If any component of the L/V need to be adapted (due to specific mission requests, to the output of mission analysis, etc.), adaptation, in terms of specification, definition, and justification, will be implemented in accordance with standard qualification and quality rules. The customer will be involved in this process.

7.3.2. L/V flight readiness review (RAV "Revue d'Aptitude au Vol")

The review verifies that the launch vehicle, expected to start the launch campaign, is technically capable to execute its mission. During this review, all changes, non-conformities and waivers encountered during production, acceptance tests and storage will be presented and justified. Moreover the L/V-S/C interfaces will be examined with reference to the DCI as well as the status of the launch operational documentation and CSG facility readiness.

The review is conducted by Arianespace and the customer is invited to attend.

The review will conclude on the authorization to begin the L/V launch campaign or on the reactivation of the L/V preparation if that L/V has performed a first part of its integration.

7.4. Systems engineering support

The Arianespace's launch service includes the engineering tasks conducted to insure the system compatibility between the spacecraft, its mission, and the launch system, as well as the consistency of their respective interfaces. The final target of this activity is to demonstrate the correct dimensioning of the spacecraft, the ability of the launch vehicle to perform the mission, to perform the hardware and software customization for the launch, and to confirm after the launch the predicted conditions. In this regard, the following activities are included:

- Interface management,
- Mission analysis,
- Spacecraft compatibility verification,
- Post-launch analysis.

In some cases, engineering support can be provided before contract signature to help the spacecraft platform design process or to verify the compatibility with the launch vehicle. This activity can be formalized in a Compatibility Agreement for a spacecraft platform.

7.4.1. Interface management

The technical interface management is based on the Interface Control Document (DCI "Document de Contrôle d'Interface"), which is prepared by Arianespace using inputs from the technical specification of the Launch Service Agreement and from the Application to Use Arianespace's L/V (DUA) provided by the customer (the DUA template is presented in annex 1). This document compiles all agreed spacecraft mission parameters, outlines the definition of all interfaces between the launch system (L/V, operations and ground facilities) and spacecraft, and illustrates their compatibility.

Nominally, two major updates of the DCI are provided in the course of the mission after the release of the initial version (Issue 0) as a consequence of the LSA signature:

- an update after the Preliminary Mission Analysis Review (Issue 1),
- an update after the Final Mission Analysis Review (Issue 2).

All modifications of the DCI are approved by Arianespace and the customer before being implemented and the different versions of the DCI shall be signed by both Parties.

This document is maintained under configuration control until launch. In the event of a contradiction, the document takes precedence over all other technical documents.

7.4.2. Mission Analysis

7.4.2.1. Introduction

To design the L/V mission and to ensure that the mission objectives can be achieved and that the spacecraft and the launch vehicle are mutually compatible, Arianespace conducts the Mission Analysis.

The Mission Analysis is generally organized in two phases, each linked to spacecraft development milestones and to the availability of spacecraft input data. These phases are:

- the Preliminary Mission Analysis,
- the Final Mission Analysis, taking into account the actual flight configuration.

Depending on spacecraft and mission requirements and constraints, the Statement of Work sets the list of provided analysis. Typically, the following decomposition is used:

Analysis	Preliminary run	Final run
Trajectory, performance, and injection accuracy analysis	✓	✓
Spacecraft separation and collision avoidance analysis	✓	✓
Dynamic coupled loads analysis (CLA)	✓	✓
Electromagnetic and RF compatibility analysis,	✓	✓
Thermal analysis		✓

Note: The Customer can require additional analysis as optional services.
Some of the analyses can be reduced or canceled in case of a recurrent mission.

Mission analysis begins with a kick-off meeting. At the completion of each phase, a Mission Analysis Review (RAMP "Revue d'Analyse de Mission Préliminaire" and RAMF "Revue d'Analyse de Mission Finale"), is held under the joint responsibility of Arianespace and the customer with support of the appropriate documentation package.

7.4.2.2. Preliminary Mission Analysis

The purposes of the Preliminary Mission Analysis are as follows:

- to describe the compliance between the L/V and the Spacecraft,
- to evaluate the environment seen by the Spacecraft to enable the customer to verify the validity of Spacecraft dimensioning,
- to review the Spacecraft test plan (see chapter 4),
- to identify all open points in terms of mission definition that shall be closed during the Final Mission Analysis,
- to identify any deviation from the User's Manual (waivers).

The output of the Preliminary Mission Analysis will be used to define the adaptation of the mission, flight, and ground hardware or to adjust the spacecraft design or test program as needed. Based on the results of the RAMP, the DCI will be updated, reissued and signed by both parties as Issue 1.

7.4.2.2.1. Preliminary trajectory, performance and injection accuracy analysis

The preliminary trajectory, performance and injection accuracy analysis comprises:

- definition of the preliminary reference trajectory and verification of the short and long range safety aspects,
- definition of flight sequences up to separation command and deorbitation of the upper stage if necessary,
- definition of the orbital parameters at separation,
- evaluation of nominal performance and the associated margins with regard to spacecraft mass and propellant reserves and preliminary assessment of launch mass budget,
- evaluation of orbit accuracy,
- verification of compliance with attitude requirements during powered flight, if any,
- the tracking and ground station visibility plan.

7.4.2.2.2. Preliminary spacecraft separation and collision avoidance analysis

The preliminary spacecraft separation and collision avoidance analysis comprises:

- verification of the feasibility of the required orientation,
- verification of the post separation kinematic conditions requirements taking into account sloshing effect,
- evaluation of the relative velocity between the Spacecraft and the L/V and their respective attitude,
- definition of the necessary separation energy,
- clearance evaluation during spacecraft separation,
- short and long-term non-collision prospects after spacecraft separation,
- verification of compliance with attitude requirements during ballistic phase,
- verification of compliance with the contamination requirements.

7.4.2.2.3. Preliminary dynamic coupled loads analysis (CLA)

The preliminary CLA uses a preliminary spacecraft dynamic model provided by the customer according to the Arianespace specification.

The preliminary dynamic CLA:

- performs the modal analysis of the L/V and the Spacecraft,
- provides the dynamic responses of the Spacecraft for the most severe load cases induced by the L/V,
- gives at nodes selected by the Customer, the min-max tables and the time history of forces, accelerations, and relative deflections as well as L/V-Spacecraft interface acceleration and force time histories,
- provides inputs to analyze with Arianespace requests for notching during the Spacecraft qualification tests.

The results of the CLA allow the Customer to verify the validity of the spacecraft dimensioning and to adjust its qualification test plan, if necessary, after discussion with Arianespace.

7.4.2.2.4. Preliminary electromagnetic and RF compatibility analysis

This study allows Arianespace to check the compatibility between the frequencies used by the L/V, the range and the Spacecraft during launch preparation and flight. The analysis is intended to verify that the spacecraft-generated electromagnetic field is compatible with L/V and range susceptibility levels, and vice versa, as defined in the chapter 3 and 4 of this manual.

The Spacecraft frequency plan, provided by the customer in accordance with the DUA template, is used as input for this analysis.

The results of the analysis allow the customer to verify the validity of the Spacecraft dimensioning and to adjust its test plan or the emission sequence if necessary.

7.4.2.3. Final Mission Analysis

The Final Mission Analysis focuses on the actual flight plan and the final flight prediction. The Final Mission Analysis sets the mission baseline, validates data for flight program generation, demonstrates the mission compliance with all spacecraft requirements, and reviews the spacecraft test results (see chapter 4) and states on its qualification.

Once the Final Mission Analysis results have been accepted by the customer, the mission is considered frozen. The DCI will be updated and reissued as Issue 2.

7.4.2.3.1. Final trajectory, performance, and injection accuracy analysis

The final trajectory analysis defines:

- the L/V performance, taking into account actual L/V (mass breakdown, margins with respect to propellant reserves, propulsion parameters adjustments, etc...) and Spacecraft properties,
- the nominal trajectory or set of trajectories (position, velocity and attitude) for confirmed launch dates and flight sequence, and the relevant safety aspects (short and long range),
- the flight events sequence for the on-board computer,
- the position, velocity and attitude of the vehicle during the boosted phase,
- the orbital parameters obtained at the time of spacecraft separation,
- the injection orbit accuracy prediction,
- the tracking and ground station visibility plan,

The final analysis data allows the generation of the flight software.

7.4.2.3.2. Final spacecraft separation and collision avoidance analysis

The final spacecraft separation and collision avoidance analysis updates and confirms the preliminary analysis for the latest configuration data and actual spacecraft parameters.

It allows Arianespace to define the data to be used by the on-board computer for the orbital phase (maneuvers, sequence).

7.4.2.3.3. Final dynamic coupled load analysis

The final CLA updates the preliminary analysis, taking into account the latest model of the spacecraft, validated by tests and actual flight configuration. It provides:

- for the most severe load cases:
 - the final estimate of the forces and accelerations at the interfaces between the adapter and the spacecraft,
 - the final estimate of forces, accelerations, and deflections at selected spacecraft nodes,
- the verification that the Spacecraft acceptance test plan and associated notching procedure comply with these final data.

7.4.2.3.4. Final electromagnetic and RF compatibility analysis

The final electromagnetic and RF compatibility analysis updates the preliminary study, taking into account the final launch configuration and final operational sequences of RF equipment with particular attention on electromagnetic compatibility between spacecraft in the case of dual launches.

7.4.2.3.5. Thermal analysis

The thermal analysis takes into account the thermal model provided by the Customer in accordance with Arianespace specification. For ground operations, it provides a time history of the temperature at nodes selected by the customer in function of the parameters of air ventilation around the spacecraft. During flight and after fairing jettisoning, it provides a time history of the temperature at critical nodes, taking into account the attitudes of the L/V during the entire launch phase.

The study allows Arianespace to define the ventilation parameters which will be apply during operations.

7.4.3. Spacecraft design compatibility verification

In close relationship with mission analysis, Arianespace will support the customer in demonstrating that the spacecraft design is able to withstand the L/V environment. For this purpose, the following reports will be required for review and approval:

- **A spacecraft environment test plan** correlated with requirements described in chapter 4. Customers shall describe their approach to qualification and acceptance tests. This plan is intended to outline the customer's overall test philosophy along with an overview of the system-level environmental testing that will be performed to demonstrate the adequacy of the spacecraft for ground and flight loads (e.g., static loads, vibration, acoustics, and shock). The test plan shall include test objectives and success criteria, test specimen configuration, general test methods, and a schedule. It shall not include detailed test procedures.
- **A spacecraft environment test file** comprising theoretical analysis and test results following the system-level structural load and dynamic environment testing. This file should summarize the testing performed to verify the adequacy of the spacecraft structure for flight and ground loads. For structural systems not verified by test, a structural loads analysis report documenting the analyses performed and resulting margins of safety shall be provided.

Reviewing these documents, Arianespace verifies the S/C qualification to the AR5 environment at the RAMP and RAMF as well as through the acceptability of the associated waivers. The S/C qualification status is presented at the RAV.

The conclusion of the mechanical and electrical fit-check (if required) between the spacecraft and launch vehicle will also be presented at the RAV.

Arianespace requests to attend environmental tests for real time discussion of notching profiles and tests correlations.

7.4.4. Post-launch analysis

7.4.4.1. Injection Parameters

During the flight, the spacecraft physical separation confirmation will be provided in real time to the customer.

Arianespace will give within 1 hour after last separation the first formal diagnosis and information sheets to the Customer, concerning the orbit characteristics and attitude of the spacecraft just before its separation.

For additional verification of the L/V performance, Arianespace requires the customer to provide satellite orbital tracking data on the initial spacecraft orbits including attitude just after separation if available.

The first flight results based on real time flight assessment will be presented during Post Flight Debriefing next to launch day.

7.4.4.2. Flight synthesis report (DEL "Document d'Evaluation du Lancement")

Arianespace provides the customer with a flight synthesis report within 1.5 months after launch or 1 month after receipt of the orbital tracking report from the Customer, whichever is later. This report covers all launch vehicle/payload interface aspects, flight events sequence, L/V performance, injection orbit and accuracy, separation attitude and rates, records for ground and flight environment, and on-board system status during flight. It is issued after the level-0 post flight analyses. These analyses, performed by experts, compare all recorded in-flight parameters to the predictions. The subsequent actions and their planning are then established by a steering committee.

7.5. Launch campaign

7.5.1. Introduction

The spacecraft launch campaign formally begins with the delivery in CSG of the spacecraft and/or its associated GSE, and concludes with GSE clearing after launch.

Prior to the launch campaign, the preparation phase takes place, during which all operational documentation is issued and the facilities compliance with customer needs is verified.

The launch campaign is divided in three major parts differing by operation responsibilities and facility configuration, as following:

- **Spacecraft preparation**

It includes the operations conducted from the spacecraft arrival to the CSG, and up to the readiness for combined operations with the L/V, and is performed in two steps:

- phase 1: spacecraft preparation and checkout
- phase 2: spacecraft propellant filling operations (hazardous)

The operations are managed by the customer with the support and coordination of Arianespace for what concerns the facilities, supplying items and services. The operations are carried out mainly in the PPF and the HPF of the CSG. The major operational document used is the Interleaved Operation Plan (POI "Plan d'Opérations Imbriquées").

- **Combined operations**

It includes the spacecraft mating with the flight adapter, its integration with the launch vehicle, the verification procedures, and the transfer to the launch pad.

The operations are managed by Arianespace with direct customer's support. The operations are carried out mainly in the BAF of the CSG. The major operational document used is the Combined Operation Plan (POC "Plan d'Opérations Combinées").

- **Launch countdown**

It covers the last launch preparation sequences up to the launch. The operations are carried out at the launch pad with a dedicated Arianespace/customer organization.

The following paragraphs provide the description of the preparation phase, launch campaign organization and associated reviews and meetings, as well as a typical launch campaign flow chart.

7.5.2. Spacecraft launch campaign preparation phase

During the launch campaign preparation phase, to ensure activity coordination and compatibility with CSG facility, Ariespace issues the following operational documentation based on the Application to use Ariespace's Launch Vehicles (DUA) and the Spacecraft Operations Plan (POS "Plan des Operations Satellite"):

- an Interleaved Operation Plan (POI)
- a Combined Operations Plan (POC)
- the set of detailed procedures for combined operations
- a countdown manual

For the Customer benefit, Ariespace can organize a CSG visit for Satellite Operations Plan preparation. It will comprise the visit of the CSG facilities, review of a standard POC Master Schedule as well as a verification of DCI provisions and needs.

The operational documentation and related items are discussed at the dedicated technical meetings and the status of the activity is presented at the final operation meeting.

7.5.2.1. Operational documentation

7.5.2.1.1. Application to Use Ariespace's Launch Vehicles (DUA "Demande d'utilisation Ariespace")

Besides interfaces details, spacecraft characteristics, the DUA presents operational data and launch campaign requirements. See annex 1.

7.5.2.1.2. Spacecraft Operations Plan (POS)

The Customer has to prepare a Spacecraft Operations Plan (POS "Plan d'Opérations Satellite") defining the operations to be executed on the spacecraft from arrival in French Guiana, including transport, integration, checkout and fuelling before assembly on the L/V, and operations on the Launch Pad. The POS defines the scenario for these operations, and specifies the corresponding requirements for their execution. It can be updated till the beginning of the launch campaign.

A typical format for this document is shown in annex 1.

7.5.2.1.3. Interleaved Operation Plan (POI)

Based on the Spacecraft Operations Plan and on the interface definition presented in the DCI, Ariespace will issue an Interleaved Operation Plan (POI "Plan d'Opérations Imbriquées") that will define all spacecraft preparations from the time of arrival of each spacecraft and associated GSE equipment in French Guiana, until the launch.

To facilitate the coordination, only one POI is issued for all passengers of a launch vehicle. It is approved by each of them.

7.5.2.1.4. Combined Operation Plan (POC)

Based on the Spacecraft Operations Plan and on the interface definition presented in the DCI, Arianespace will issue a Combined Operation Plan (POC "Plan d'Opérations Combinées") that will outline all activities involving the Spacecraft and the launch vehicle simultaneously, in particular:

- combined operations scenario and Launch Vehicle activities interfacing with the Spacecraft,
- identification of all non reversible and non interruptible Spacecraft and Launch Vehicle activities,
- identification of all hazardous operations involving the spacecraft and/or L/V activities,
- operational requirements and constraints imposed by each satellite and the launch vehicle,
- a reference for each operation to the relevant detailed procedure and associated responsibilities.

Where necessary, this document will be updated before the POC to reflect the true status of the work. In order to take into account real time coordination, a day to day schedule is reviewed every day during the POC.

The Combined Operation Plan is prepared by Arianespace and submitted to the Customer's approval.

The POC is approved at the Combined Operations Readiness Review (BT POC "Bilan Technique POC").

7.5.2.1.5. Detailed operation sheets for combined operations

Two types of combined operations are identified:

- operations involving each spacecraft or launch vehicle independently: these operation sheets are specific for each Authority,
- operations involving spacecraft / launch vehicle interaction managed by common operation sheets.

Typically the operation sheets include the description of the activities to be performed, the corresponding sequence, the identification of the responsibilities, the required support and the applicable constraints.

The operation sheets are prepared by Arianespace and the Customer during POC preparation meeting.

7.5.2.1.6. Countdown Manual

Based on the Spacecraft Operations Plan, Arianespace establishes documents which detail all information relevant to the countdown processing on launch day, including:

- a detailed countdown sequence flow (so called countdown procedure), including all communication exchanges (instruction, readiness status, progress status, parameters, etc.) performed on launch day
- Go/No-Go criteria
- communications network configuration
- list of all authorities who will interface with the Customer, including launch team members' names and functions
- launch abort sequence.

7.5.3. Launch campaign organization

7.5.3.1. Spacecraft launch campaign management

During the operations at CSG, the customer interfaces with the Mission Director (CM "Chef de Mission"). The Program Director, the customer's contact in the previous phases, maintains his responsibility for all non-operational activities.

The Range Operations Manager (DDO) interfaces with the Mission Director. He/She is in charge of the coordination of all the range activities dedicated to customer's support:

- support in the Payload Preparation Complex (transport, telecommunications, etc.),
- weather forecast for hazardous operations,
- ground safety of operations and assets,
- security and protection on the range,
- launcher down range stations set-up for flight.

The launch campaign organization is presented in figure 7.5.3.1.a.

Positions and responsibilities are briefly described in table 7.5.3.1.b.

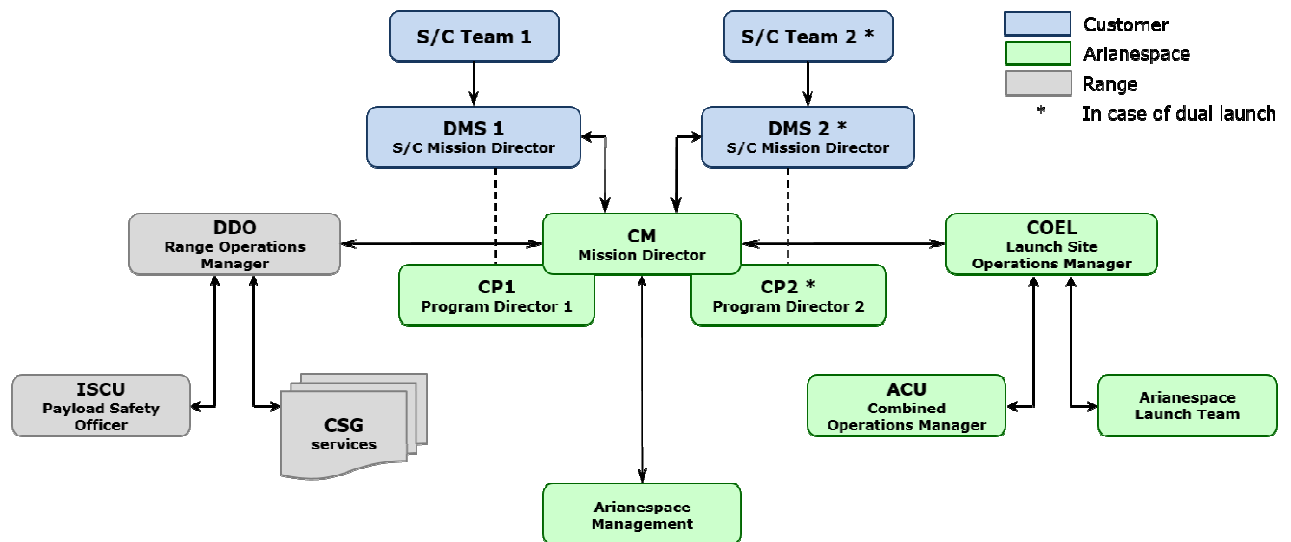

Figure 7.5.3.1.a – Launch campaign organization

The Customer representative

DMS Spacecraft Mission Director – " <i>Directeur de la Mission Satellite</i> "	Responsible for spacecraft preparation to launch and spacecraft launch campaign. DMS reports S/C and S/C ground network readiness during final countdown and provides confirmation of the spacecraft acquisition after separation.
--	--

The Spacecraft Manufacturer representatives

CPS Spacecraft Project Manager – " <i>Chef de Projet Satellite</i> "	CPS manages the S/C preparation team. Usually he is representative of the S/C manufacturer.	
RPS Spacecraft Preparation Manager – " <i>Responsable de la Préparation Satellite</i> "	Responsible for the preparation, activation, and checkout of the spacecraft. Provides final S/C status to DMS during countdown.	CPSA Deputy Spacecraft Project Manager – " <i>Adjoint au Chef de Projet Satellite</i> "

The Arianespace representatives

PDG Chairman & CEO – " <i>Président Directeur Général</i> " supported by DTQ	Ensures the Arianespace's commitments fulfillment. Flight Director during final countdown.	DTQ Senior Vice President Chief Technical Officer – " <i>Directeur Technique et Qualité</i> "	Chairman of launch vehicle flight readiness review (RAV) and launch readiness review (RAL).
CM Mission Director – " <i>Chef de Mission</i> "	Responsible for preparation and execution of the launch campaign and final countdown.	CP Arianespace Program Director – " <i>Chef de Projet</i> "	Responsible for the contractual aspects of the launch.
COEL Launch Site Operations Manager – " <i>Chef des Opérations Ensemble de Lancement</i> "	Responsible for the overall management of the SLV, CSG activities and launch authorization.	CPAP Arianespace Production Project Manager – " <i>Chef de Projet Arianespace Production</i> "	Launch vehicle authority: coordinates all technical activities allowing to state the LV flight readiness.
ACU Combined Operations Manager – " <i>Adjoint Charge Utile</i> "	COEL's deputy in charge of all interface operations between S/C and L/V.	ISLA Launch Area Safety Officer – " <i>Ingénieur Sauvegarde Lancement Arianespace</i> "	Representative of the Safety Responsible on the launch site.

The Guiana Space Center (CSG) representatives

CG/D Range Director – " <i>Directeur du CSG</i> "	Ensures the CSG's commitments fulfillment.		
DDO Range Operations Manager – " <i>Directeur Des Opérations</i> "	Responsible for the preparation, activation and use of the CSG facilities and down-range stations and their readiness during launch campaign and countdown.	RMCU Payload facilities Manager – " <i>Responsable des Moyens Charge Utile</i> "	Responsible for EPCU maintenance and technical support for operations in the EPCU facilities.
ISCU Payload Safety Officer – " <i>Ingénieur Sauvegarde Charge Utile</i> "	Responsible for the monitoring of the payload hazardous operations.	RSV Flight Safety Responsible – " <i>Responsable Sauvegarde Vol</i> "	Responsible for the applications of the CSG safety rules during flight.

Table 7.5.3.1.b – Positions and responsibilities

7.5.3.2. Launch countdown organization

A typical operational countdown organization is presented on figure 7.5.3.2.a reflecting the Go/NoGo decision path and responsibility tree.

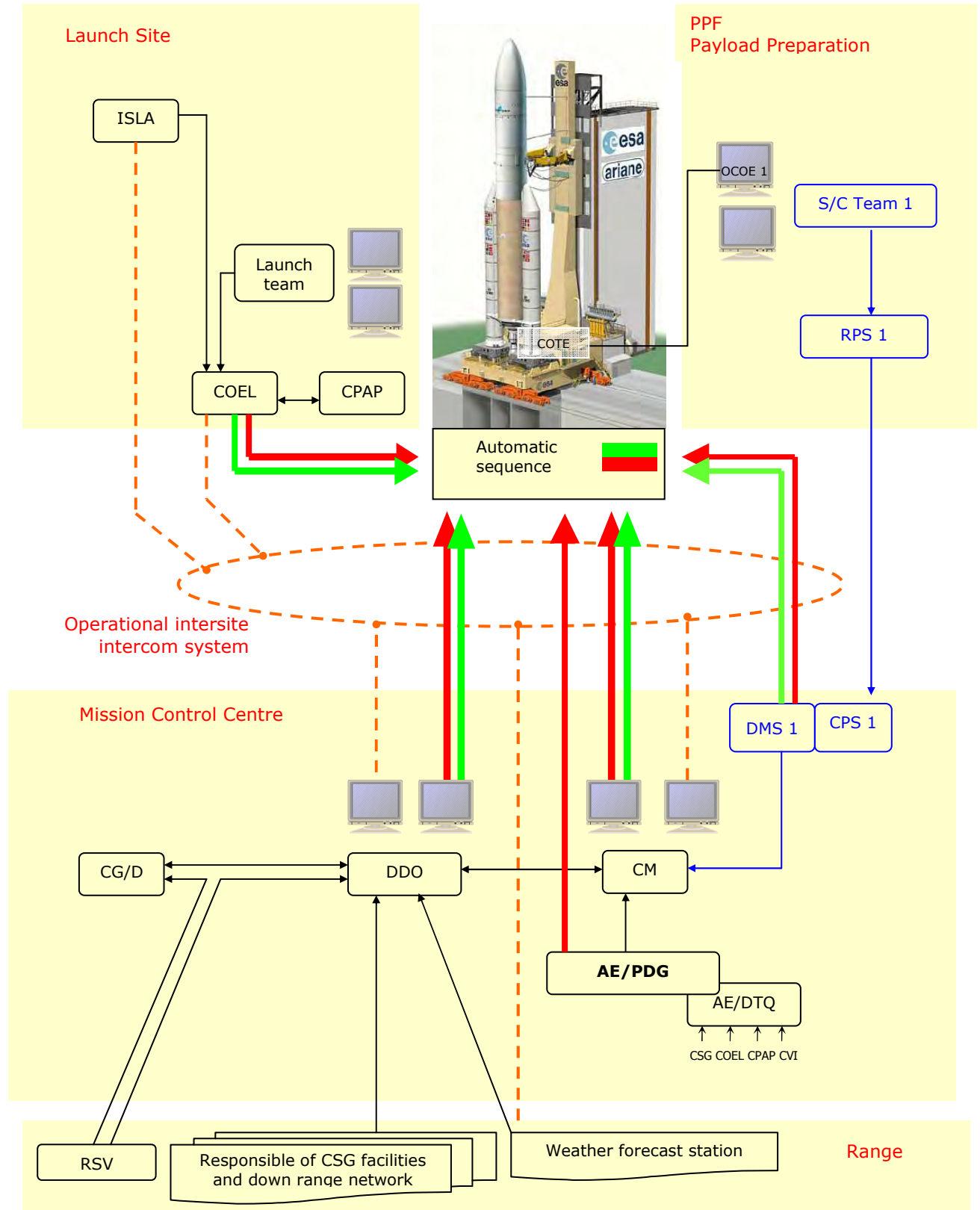

Figure 7.5.3.2.a – Countdown organization

7.5.4. Launch campaign meetings and reviews

7.5.4.1. Introduction

The launch preparation is carried out in permanent interaction between the customer and the L/V team. This interface is under the responsibility of the Arianespace Mission Director who may be assisted by Arianespace L/V campaign responsible, upon request. A few more formalized meetings and reviews take place at major milestones of the operational process.

7.5.4.2. Spacecraft pre-shipment review

Arianespace wishes to be invited to the pre-shipment or equivalent review, organized by the customer and held before shipment of the spacecraft to the CSG.

Besides spacecraft readiness, this review may address the CSG and launch vehicle readiness status that will be presented by Arianespace.

7.5.4.3. Spacecraft transport meeting

Arianespace will hold a preparation meeting with the customer at the CSG, before spacecraft transportation, typically 3 days before S/C arrival in French Guiana. The readiness of the facilities at entrance port, and at CSG for the spacecraft arrival, as well as status of formal issues, and transportation needs will be verified.

7.5.4.4. EPCU acceptance review certificate

On request, before the spacecraft arrival in the EPCU, an acceptance review certificate may be delivered by Arianespace to the customer.

This certificate attests that the facilities are configured following DCI requirements.

7.5.4.5. Combined operations readiness review (BT POC "Bilan Technique POC")

The objective of this review is to demonstrate the readiness of the spacecraft, the flight items and the CSG facilities to start the combined operations according to POC. It addresses the following main points:

- POC presentation, organization and responsibility for combined operations,
- the readiness of the upper composite items (adapter, fairing, any other involved item): preparation status, non-conformities and waivers overview,
- the readiness of the BAF and launch pad facilities and information on the L/V preparation,
- the readiness of the spacecraft,
- the mass of the spacecraft in its final launch configuration.

7.5.4.6. Preliminary Launch Readiness Review (pre-RAL)

A preliminary Launch Readiness Review providing more specific and detailed presentation on the mission aspects is held for the benefit of the customer usually the day before the Launch Readiness Review itself. The review covers:

- a synthesis of the significant items that will be presented in the Launch Readiness Review (RAL),
- any additional clarification that may result from previous written questions raised by the customer.

7.5.4.7. Launch Readiness Review (RAL "Revue d'Aptitude au Lancement")

A Launch Readiness Review is organized after the Dress Rehearsal and held the day before the roll-out of the L/V to the launch pad. It authorizes the filling of the L/V cryogenic stages and the pursuit of the final countdown and launch. This review is conducted by Arianespace. The customer is invited to attend.

The following points are addressed during this review:

- the L/V hardware, software, propellants and consumables readiness including status of non-conformities and waivers, results of the dress rehearsal, and quality report,
- the readiness of the spacecraft, Customer's GSE, voice and data spacecraft communications network, including ground stations, and control center,
- the readiness of the range facilities (launch pad, communications and tracking network, weather forecast, EMC status, general support services),
- the countdown operations presentation for nominal and possible postponed launch, and Go/No-Go criteria finalization,
- a review of logistics and public relations activities.

7.5.4.8. Post flight debriefing (CRAL "Compte-Rendu Après le Lancement")

The day after the actual J0, Arianespace draws up a report to the customer, on post flight analysis covering flight event sequences, evaluation of L/V performance, and injection orbit and accuracy parameters.

7.5.4.9. Launch service wash-up meetings

At the end of the campaign, Arianespace organizes wash-up meetings.

The technical wash-up meeting collects the feedback from customers on the services provided from the beginning of the project and up to the launch campaign and launch.

The contractual wrap-up meeting is organized to close all contractual items.

7.5.5. Summary of a typical launch campaign

7.5.5.1. Launch campaign time line and scenario

The Spacecraft campaign duration, from equipment arrival in French Guiana until beginning of POC, shall not exceed 15 working days..

The Spacecraft shall be available for combined operations 12 (D-11 for upper S/C) or 10 (D-9 for lower S/C) working days prior to the Launch, at the latest, as it will be agreed in the operational documentation.

The Spacecraft check-out equipment and specific COTE (Check Out Terminal Equipment - see para. 7.5.5.4.) necessary to support the Spacecraft/Launch Vehicle on-pad operations shall be made available to Arianespace, and validated, 2 days prior to operational use according to the approved operational documentation, at the latest. After launch, the COTE can be at the earliest removed from the table on the launch pad on D+1 working day (provided it complies with the requirements in § 6.2.3.1.2).

All Spacecraft mechanical and electrical support equipment shall be removed from the various EPCU buildings (LBC and offices) and Launch Table, packed and made ready for return shipment within 3 working days after the Launch. For PPF and HPF clearing, see A3.7.2.

7.5.5.2. Spacecraft autonomous preparation

7.5.5.2.1. Phase 1: Spacecraft arrival preparation and check-out

A typical flow diagram of phase 1 operations is shown in figure 7.5.5.2.1.a.

The spacecraft and its associated GSE arrive at the CSG through one of the entry ports described in chapter 6.

Equipment should be packed on pallets or in containers and protected against rain and condensation.

After formal procedures, the spacecraft and GSE are transferred by road to CSG's appropriate facilities on the CSG transportation means. On arrival at the PPF, the customer is in charge of equipment unloading and dispatching with CSG and Arianespace support. The ground equipment is unloaded in the transit hall and the spacecraft in its container is unloaded in the high-bay airlock of the PPF. If necessary, pyrotechnic systems and any other hazardous systems of the same class can be stored in the pyrotechnic devices buildings of the ZSP (Pyrotechnical Storage Area). Hazardous fluids are stored in a dedicated propellant storage area.

In the Spacecraft Operations Plan (POS), the customer defines the way his equipment should be arranged and laid out in the facilities. The customer states which equipment has to be stored in an air-conditioned environment. Other equipment will be stored under open shed.

Autonomous operations and checks of the spacecraft are carried out in the PPF. These activities include:

- Installation of the spacecraft checkout equipment, connection to the facilities power and operational networks with CSG support;
- Removal of the spacecraft from containers and deployment in the clean-room. This also applies for flight spare equipment;
- Spacecraft assembly and functional tests (non-hazardous mechanical and electrical tests);
- Verification of the interface with L/V, if needed, such as mechanical and/or electrical fit check,...;
- MEOP tests / leak tests;
- Battery charging.

The duration of such activities varies with the nature of the payload and its associated tests.

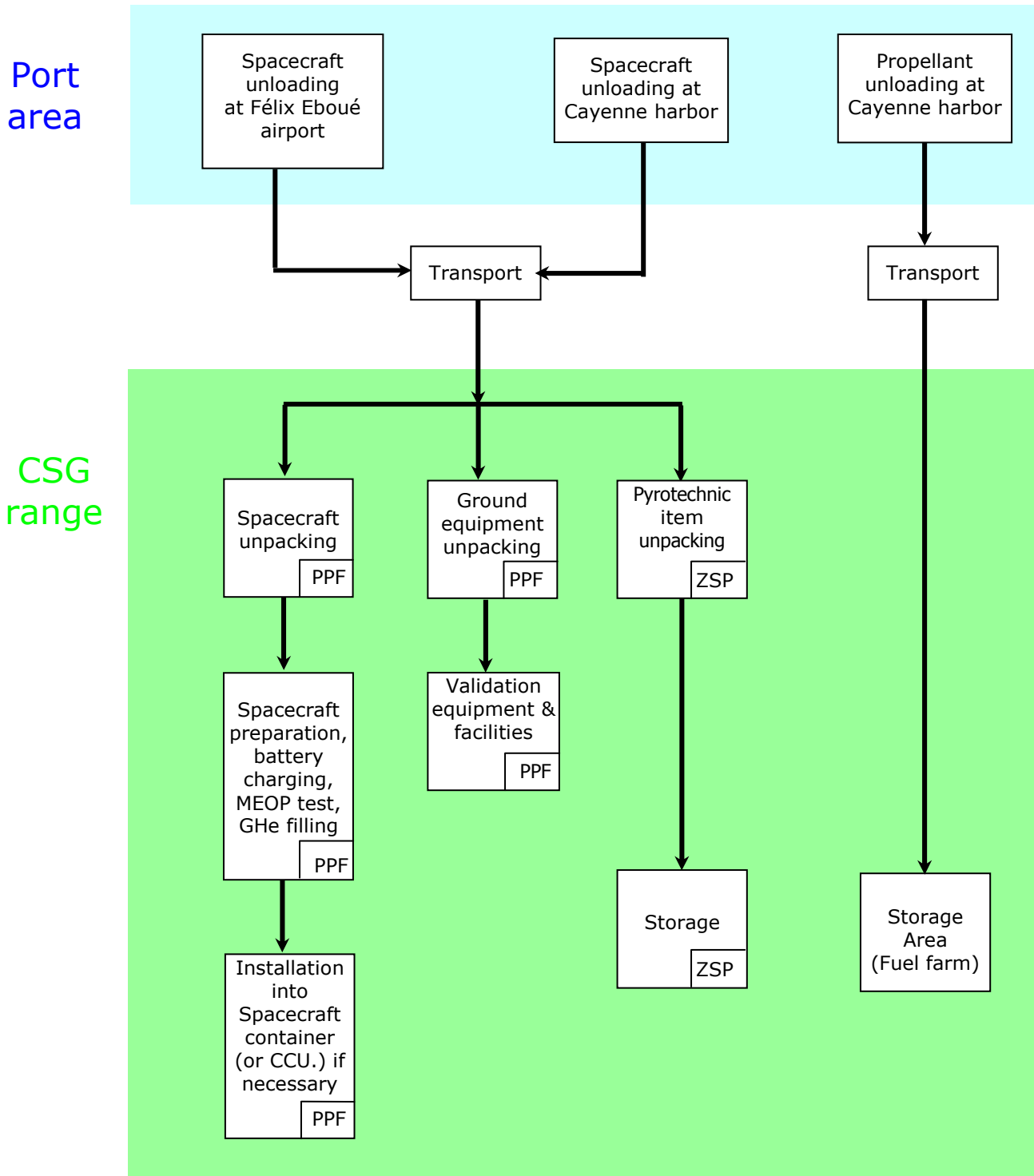

Figure 7.5.5.2.1.a – Operations phase 1: typical flow diagram

7.5.5.2.2. Phase 2: Spacecraft hazardous operations

A typical flow diagram of phase 2 operations is shown in figure 7.5.5.2.2.a.

Spacecraft filling and hazardous operations are performed in the HPF. The facility and communication network setup are provided by Arianespace.

The pyrotechnic systems are prepared and final assembly is carried out by the spacecraft team.

Arianespace brings the propellant from the storage area to the dedicated facilities of the HPF. The spacecraft team carries out the installation and validation of spacecraft GSE, such as pressurization and filling equipment, and setup of propellant transfer tanks.

The customer fills and pressurizes the spacecraft tanks to flight level.

Hazardous operations are monitored from a remote control room. CSG Safety department ensures safety during all these operations.

Flushing and decontamination of the GSE are performed by the customer in a dedicated area.

The integration of hazardous items (category A pyrotechnic devices, etc...) into spacecraft are carried out in the same way (in accordance with safety recommendations).

Load cells are available for customer in HPF. On request, S/C weighing can be performed under the customer's responsibility by Arianespace authority.

Spacecraft batteries may be charged in HPF, if needed, except during dynamic hazardous operations.

Fluids and propellants analyses are carried out by Arianespace on customer's request as described in the DCI.

7.5.5.3. Launch Vehicle Processing

The two solid strap-on boosters are integrated in the solid strap-on boosters integration building (BIP). The cryogenic central core is unloaded and prepared in the Launch Vehicle integration building (BIL), and is mated on the two strap-on boosters transferred from the strap-on boosters integration building (BIP). The strap-on boosters support the central core on the launch table. The cryogenic upper stage ESC-A is then installed on top of the cryogenic central core. The Vehicle Equipment Bay (VEB) that houses the vehicle avionics and provides the fairing interface is finally installed. The lower part of the Launch Vehicle is then transferred to the final assembly building (BAF). These activities are conducted in parallel with the spacecraft activities in PPF/HPF.

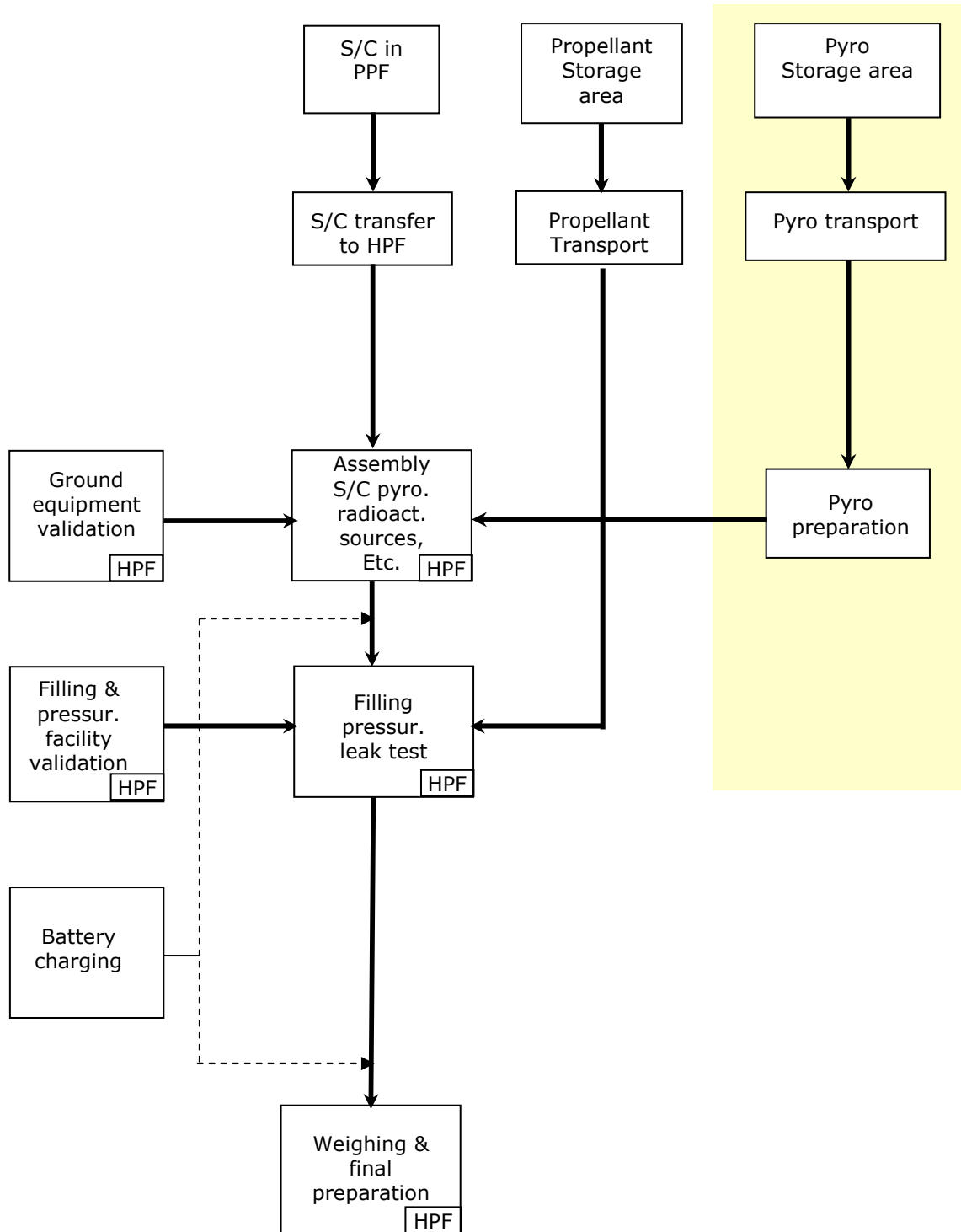

Figure 7.5.5.2.2.a – Operations phase 2: typical flow diagram

7.5.5.4. Combined Operations

All Combined Operations and launch site activities are conducted as phase 3.

A typical flow diagram of phase 3 operations is given in Figure 7.5.5.4.a.

Phase 3 operations take place in HPF facility and in the Final Assembly Building (BAF).

The combined operations carried out under Arianespace responsibility, include the following activities:

- Spacecraft and adapter assembly in HPF building
After filling and final preparation, the spacecraft is mated onto its flight adapter.
- Transport of spacecraft and installation in BAF

Arianespace is responsible for transporting the spacecraft in one of the CCU's from HPF building to the BAF building.

Umbilical lines at BAF/Launch vehicle, data/modem lines and RF links between BAF and PPF buildings have been checked previously.

The spacecraft mated to its adapter is installed into the payload container (CCU) and is then transferred by road to the BAF.

- Encapsulation Phase

The encapsulation phase is carried out by Arianespace in the Final Assembly Building (BAF).

Typical dual spacecraft encapsulation sequence

The upper spacecraft on its adapter is mated onto SYLDA 5 and then is encapsulated by the Fairing. In the meantime the lower spacecraft with its adapter, using the spacecraft handling equipment, is hoisted at the PFCU level and mated to the L/V. Finally the lower spacecraft is encapsulated by the upper composite. After the upper payload is mated and encapsulated onto Ariane 5, pneumatic and electrical umbilical plugs are connected. Ventilation is provided through the pneumatic umbilicals and each spacecraft is linked to its COTE by the connection of the electrical umbilical plug. These operations are conducted under Arianespace responsibility.

A typical dual spacecraft encapsulation is shown in figure 7.5.5.4.b.

Typical single spacecraft encapsulation sequence

Using the S/C handling equipment, the spacecraft with its adapter is hoisted at the PFCU level and mated to the L/V. The spacecraft is linked to its COTE by connection of the electrical umbilical plug (POE). After spacecraft final preparation it is encapsulated with the fairing. Ventilation is then provided through the pneumatic umbilical plug (POP).

These operations are conducted under Arianespace responsibility.

A typical single spacecraft encapsulation is shown in figure 7.5.5.4.c

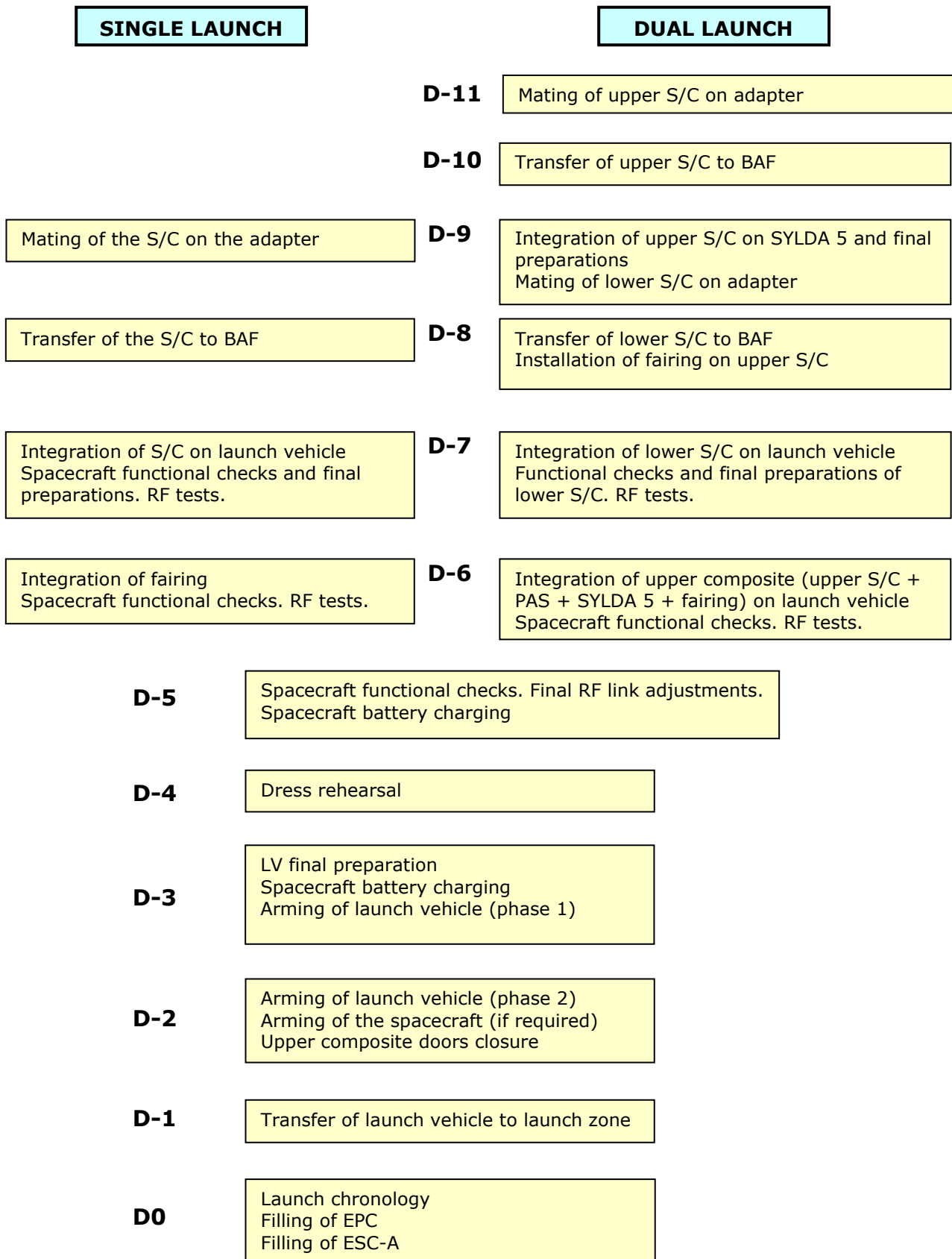

Figure 7.5.5.4.a – Operations Phase 3: typical flow diagram

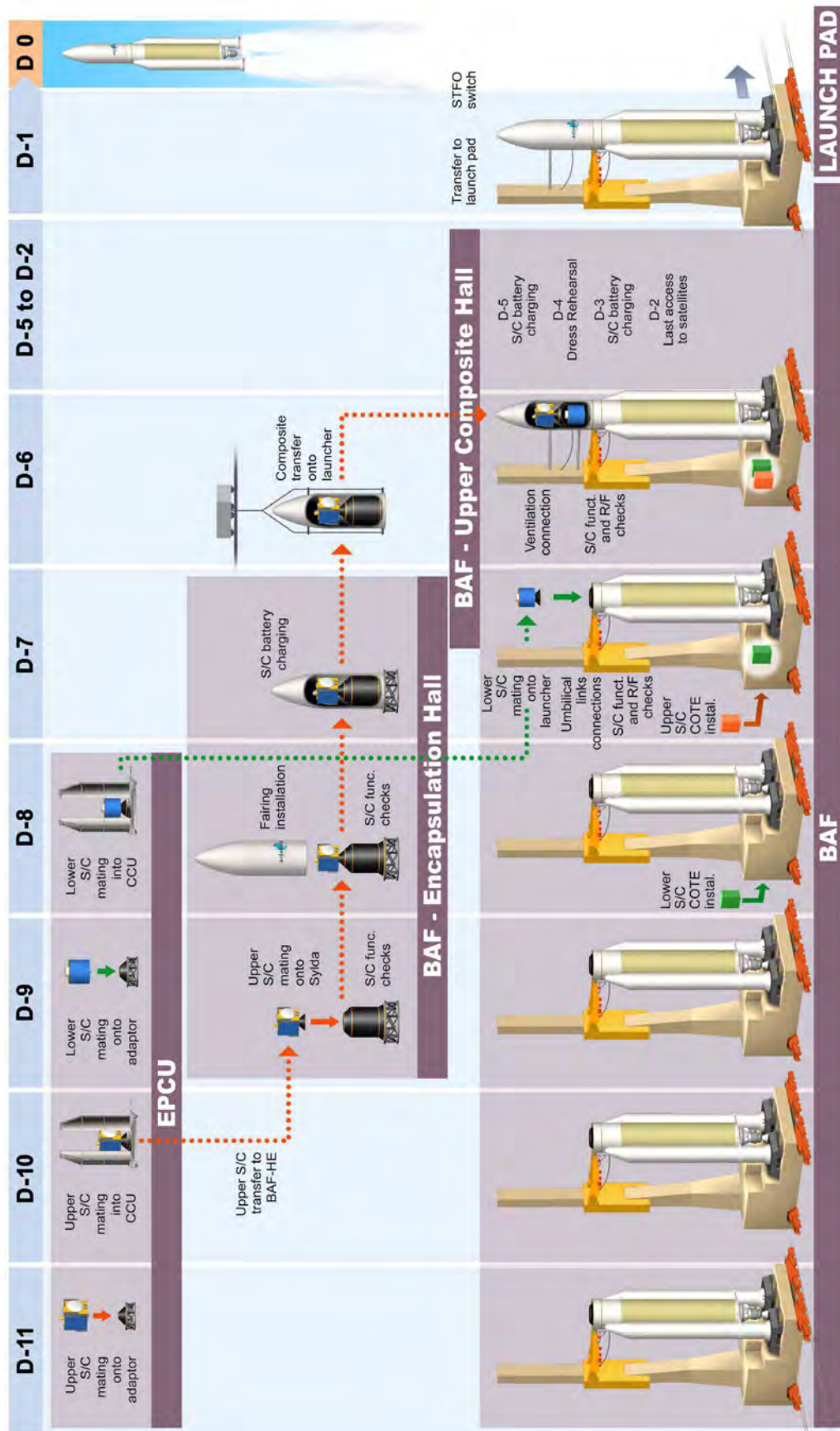

Figure 7.5.5.4.b – Typical dual launch encapsulation sequence with SYLDA 5

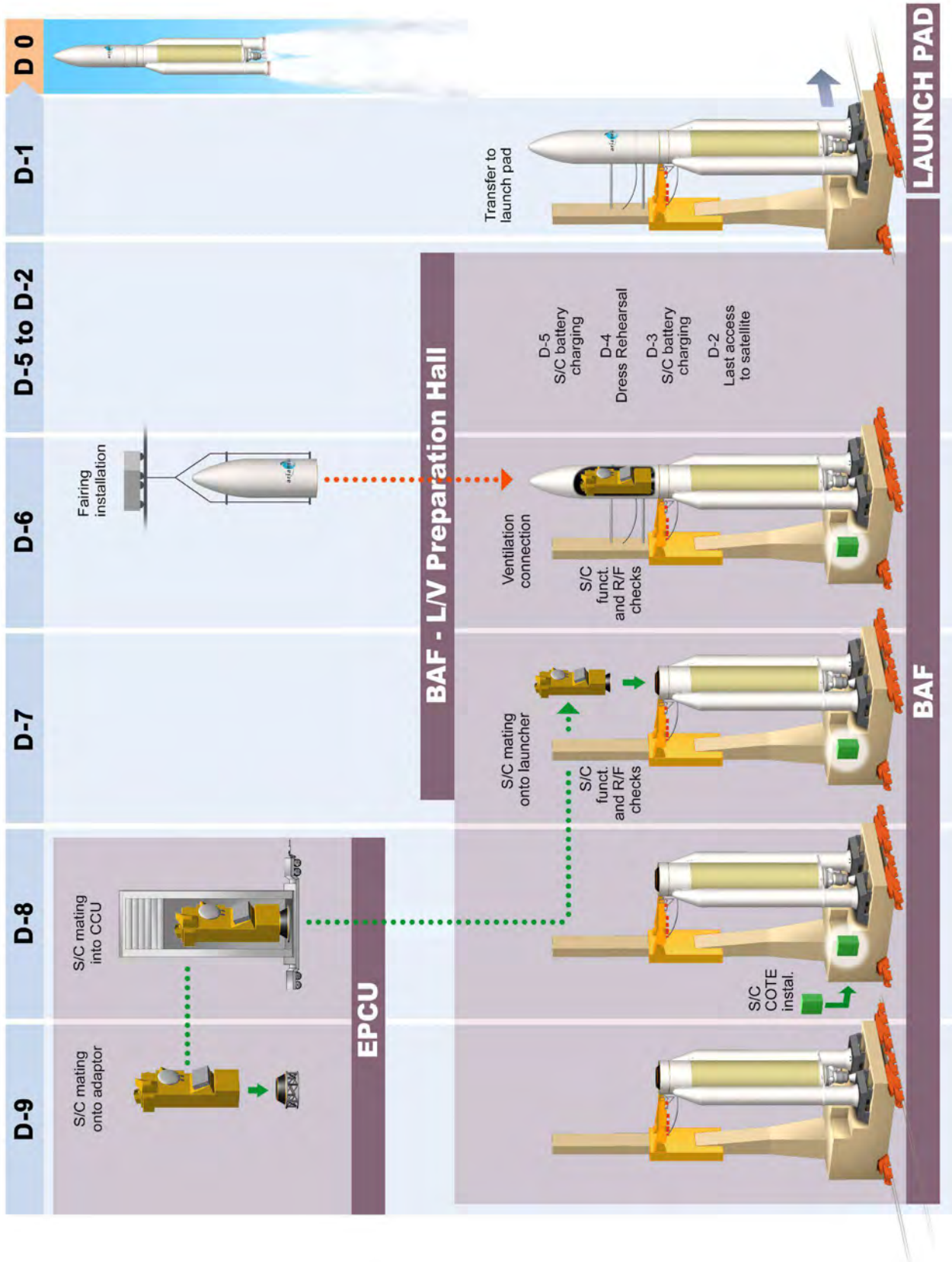

Figure 7.5.5.4.c – Typical single launch encapsulation sequence

- Preparation and checkout of the spacecraft, once mated on the launch vehicle

A spacecraft functional check is carried out in accordance with the combined activities time-schedule.

Spacecraft activities must be compliant with launch vehicle activities (accessibility and radio-silence constraints).

If required, the arming and disarming checks of hazardous circuits are carried out by the customer after clearance by Arianespace authorities.

- Launch rehearsal at D-4

A launch rehearsal is held in order to validate all the interfaces and timing at final chronology.

This rehearsal implies the participation of all entities involved in an Ariane launch together with the spacecraft voice and data communications links, including RF and ground stations.

- Checkout and preparation before launch countdown at D-2

The sequence of operations is the following:

- Arming of the launch vehicle: fitting and connection of the launch vehicle pyrotechnic devices. During this operation, access to the BAF is prohibited.
- Late access through access doors for the spacecraft final preparation.
- Closure of the spacecraft access door(s) on the fairing. No more access to the spacecraft until launch.

- Transfer of L/V from BAF to Launch Pad at D-1

- Preparation of the BAF and L/V for the transfer to the Launch Pad,
- Launch table electrical and fluids plug disconnection,
- Departure from BAF and Roll out.

Note:

During transfer from BAF to Launch Pad, spacecraft are continuously linked to their Check Out station and may be monitored (see figure 7.5.5.4.d).

- Launch Pad operations at D-1

- L/V arrival at the Launch Pad,
- Connection of launch table electrical and fluids umbilicals,
- Spacecraft launch pad links check out including RF.



Figure 7.5.5.4.d – Phase 3 operations: transfer to launch pad and chronology

- Check-out and preparation at D0

The spacecraft can be checked out via baseband, PLANET and/or RF links, according to agreed slots during the final chronology, with no physical access to COTE during D0.

The spacecraft and launch vehicle activities are shown in figure 7.5.5.4.e.

During this sequence, the main spacecraft operations are the following:

- Spacecraft RF and functional tests (health check) may be performed.
- Before starting the launch vehicle fillings, Arianespace requires a formal S/C readiness status.
- Spacecraft RF flight configuration
The final RF flight configuration set up must be completed before H0-1h30 and remains unchanged until 20 s after separation, i.e. RF transmitters levels are set-up in final launch configuration (ON or OFF according to DCI).
- Spacecraft switch on to internal power
Switch from external to internal power is performed so that the spacecraft is ready for launch in due time, and in all case at the latest at H0-7mn30s.
- L/V automatic sequence
The nominal starting point of the automatic sequence is H0-7mn.
- Countdown hold
In case of stop action during the final sequence the count down is set back to H0-7mn. When required, in coordination with Arianespace, the spacecraft can be switched back to external power.
- Spacecraft stop action
The Spacecraft Authority can stop the countdown until H0-7s.

- Launch countdown phase
The final countdown sequence starts at about H0-9 hours for the spacecraft activities.

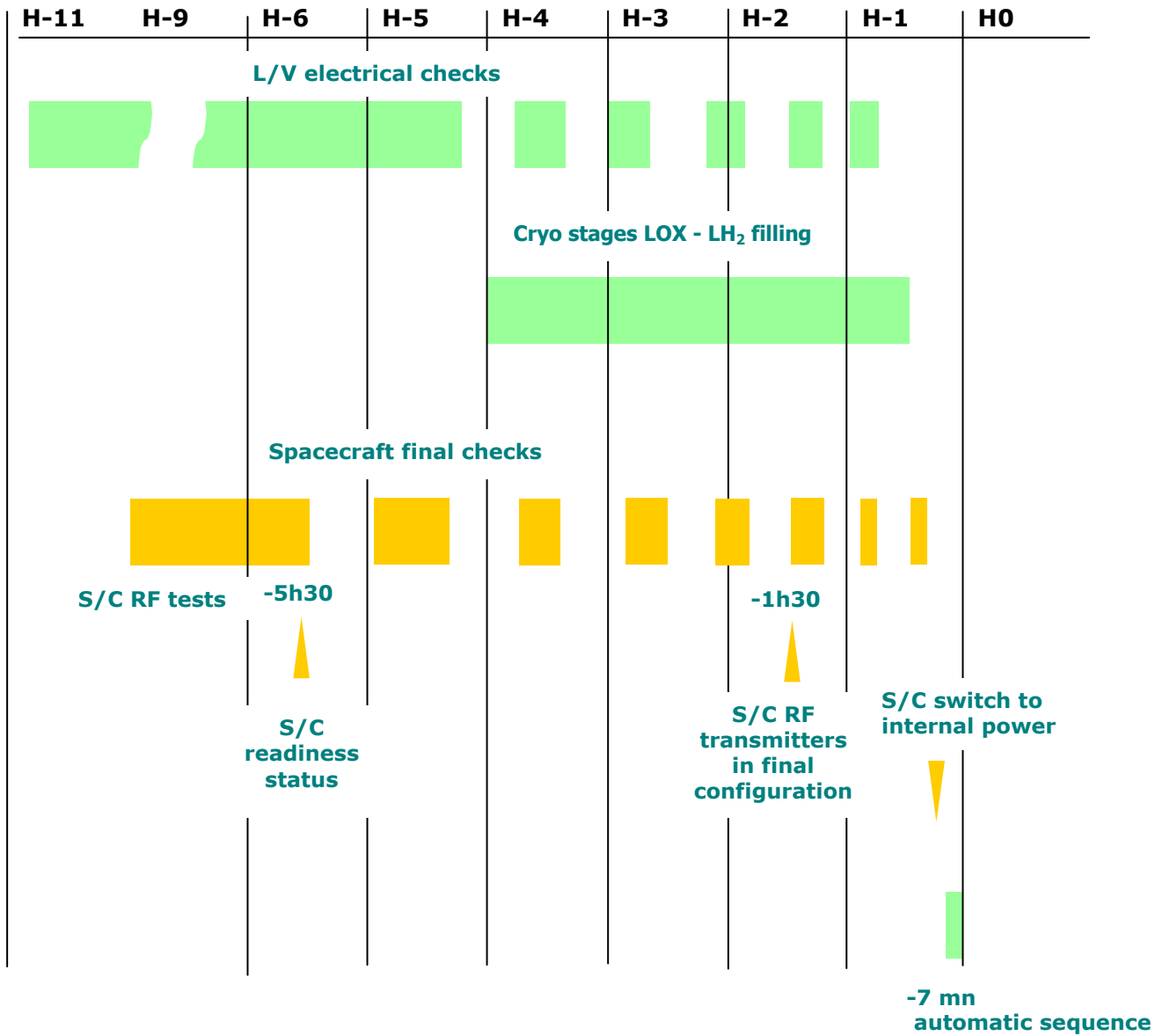

Figure 7.5.5.4.e -Typical final countdown phase

7.6. Safety assurance

7.6.1. General

The safety objectives are to protect the staff, facility and environment during launch preparation launch and flight. This is achieved through preventive and palliative actions:

- Short and long range flight safety analysis based on spacecraft characteristics and on trajectory ground track;
- Safety analysis based on the spacecraft safety submission;
- Training and prevention of accidents;
- Safety constraints during hazardous operations, and their monitoring and coordination;
- Coordination of the first aid in case of accident.

CSG is responsible for the implementation of the Safety Regulations and for ensuring that these regulations are observed. All launches from the CSG require approvals from Ground and Flight Safety Departments. These approvals cover payload hazardous systems design, all transportation and ground activities that involve spacecraft and GSE hazardous systems, and the flight plan.

These regulations are described in the document "Payload Safety Handbook"

7.6.2. Safety Submission

In order to obtain the safety approval, a customer has to demonstrate that his equipment and its operations at CSG comply with the provisions of the Payload Safety handbook. Safety demonstration is accomplished in several steps, through the submission of documents defining and describing hazardous elements and their processing. Submission documents are prepared by the customer and are sent to Arianespace providing the adequate support in the relation with CSG Authorities.

The time schedule, for formal safety submissions showing the requested deadlines, working backwards from launch date L, is presented in table 7.6.2.a. A safety checklist is given in the annex 1 to help for the establishment of the submission documents.

7.6.3. Safety training

The general safety training will be provided to the customer through video presentations and documents before or at the beginning of the launch campaign. At the arrival of the launch team at CSG a specific training will be provided with on-site visits and detailed practical presentations that will be followed by personal certification.

In addition, specific safety training on the hazardous operations, like fueling, will be given to the appointed operators, including operations rehearsals.

Table 7.6.2.a - Safety submission time schedule

Safety Submissions	Typical Schedule
<p>Phase 0 – Feasibility (optional) A customer willing to launch a satellite containing inventive and innovating systems or subsystems can obtain a safety advice from CSG through the preliminary submission</p>	<p>Before contract signature</p>
<p>Phase 1 - Design The submission of the spacecraft and GSE design and description of their hazardous systems. It shall cover component choice, safety and warning devices, fault trees for catastrophic events, and in general all data enabling risk level to be evaluated.</p>	<p>After the contract signature</p>
<p>End of Phase 1 submission</p>	<p>Not later than Preliminary Mission Analysis Review (RAMP) or L-12 months</p>
<p>Phase 2 – Integration and Qualification The submission of the refined hardware definition and respective manufacturing, qualification and acceptance documentation for all the identified hazardous systems of the spacecraft and GSE. The submission shall include the policy for test and operating all systems classified as hazardous. Preliminary spacecraft operations procedures should also be provided.</p>	<p>As soon as it becomes available and not later than L - 12 months</p>
<p>End of Phase 2 submission</p>	<p>Not later than L - 7 months</p>
<p>Phase 3 – Acceptance tests and hazardous operations The submission of the final description of operational procedures involving the spacecraft and GSE hazardous systems as well as the results of their acceptance tests if any.</p>	<p>Before campaign preparation visit or L - 6 months</p>
<p>Approval of the spacecraft compliance with CSG Safety Regulation and approbation of the procedures for autonomous and combined operations.</p>	<p>Before S/C fuelling at latest (procedures shall be provided before S/C arrival to CSG)</p>

Note:

Shorter submission process can be implemented in case of a recurrent spacecraft having already demonstrated its compliance with the CSG safety Regulations.

7.6.4. Safety measures during hazardous operations

The Spacecraft Authority is responsible for all spacecraft and associated ground equipment operations.

The CSG safety department representatives monitor and coordinate these operations for all that concerns the safety of the staff and facilities.

Any activity involving a potential source of danger is to be reported to the CSG safety department representative, which in return takes all steps necessary to provide and operate adequate collective protection, and to activate the emergency support.

Each member of the spacecraft team must comply with the safety rules regarding personal protection equipment and safety training. The CSG safety department representative permanently verifies their validity and gives the relevant clearance for the hazardous operations.

On request from the Customer, the CSG can provide specific protection equipment for members of the spacecraft team.

In case the launch vehicle, the spacecraft, and, if applicable its co-passenger imposes crossed safety constraints and limitations, the Arianespace representatives will coordinate the respective combined operations and can restrict the operations or access to the spacecraft for safety reasons.

7.7. Quality assurance

7.7.1. Arianespace's Quality Assurance system

To achieve the highest level of reliability and schedule performance, Arianespace's Quality Assurance system covers the launch services provided to the customer, and extends up to the launch vehicle hardware development and production by major and second level suppliers, in addition to their proper system imposed by their respective government organization.

Arianespace quality rules and procedures are defined in the company's Quality Manual. This process has been perfected through a long period of implementation, starting with the first Ariane launches more than 35 years ago, and is certified as compliant with the ISO 9001:V2000 standard.

The system is based on the following principles and procedures:

A. Appropriate management system

The Arianespace organization presents a well defined decisional and authorization tree including an independent Quality directorate responsible for establishing and maintaining the quality management tools and systems, and setting methods, training, and evaluation activities (audits). The Quality directorate representatives provide un-interrupted monitoring and control at each phase of the mission: hardware production, satellite-Launch vehicle compliance verification, and launch operations.

B. Configuration management, traceability, and proper documentation system

Arianespace analyses and registers the modifications or evolutions of the system and procedures, in order not to affect the hardware reliability and/or interfaces compatibility with spacecraft. The reference documentation and the rigorous management of the modifications are established under the supervision of the configuration control department.

C. Quality monitoring of the industrial activities

In complement to the supplier's product assurance system, Arianespace manages the production under the following principles: acceptance of supplier's Quality plans with respect to Arianespace Quality management specification; visibility and surveillance through key event inspection; approbation through hardware acceptance and non-conformance treatment; on site audits; quality-to-quality forums...

During the Launch campaign, at customer's request, specific meetings may be organized with the Launch Vehicle and Quality Authorities, as necessary, to facilitate the understanding of the anomalies or incidents.

The system is permanently under improvement thanks to the customer's feedback during the Launch Services Wash-up meeting at the end of the mission.

7.7.2. Customized quality reporting (optional)

In addition and upon request, Arianespace may provide the customer with a dedicated access right, and additional visibility on the overall launch system organization and status, by the implementation of:

- A **Quality System Presentation** (QSP) included in the agenda of the contractual kick-off meeting. This presentation explicitly reviews the product assurance provisions defined in the Arianespace Quality Manual,
- A **Quality System Meeting** (QSM), suggested about 10-12 months before the Launch, where the latest L/V production Quality statement is reviewed, with special emphasis on major quality and reliability aspects, relevant to customer's Launch Vehicle or Launch Vehicle batch. It can be accompanied by visits to main contractor facilities,
- A dedicated **Quality Status Review** (QSR), which can be organized about 3-4 months before the Launch to review the detailed quality log of customer's Launch Vehicle hardware.

7.8. Environmental footprint management

To ensure the sustainable nature of our business, Arianespace takes a proactive stance on minimizing the environmental impact of its activities on ground and in outer space.

Those measures are described in the corporate social responsibility report issued each other year.

In order to be as efficient as possible, Arianespace works hand in hand with ESA, CNES and the suppliers to assess and reduce the environmental impact of the launch activities starting with launcher design and production and extending to space debris management.

Arianespace is certified ISO14001 and ISO 50001 for CSG activities, since 2014.

Application to use

Arianespace's launch vehicle (DUA)

Annex 1

The customer will preferably provide the DUA as an electronic file, according to the Arianespace template.

A1.1. Spacecraft description and mission summary

Manufactured by		Model/Bus	
<i>DESTINATION</i>			
Telecommunication*	Meteorological*	Scientific*	Others*
Direct broadcasting*	Remote sensing*	Radiolocalisation*	
<i>MASS</i>		<i>DIMENSIONS</i>	
Total mass at launch	TBD kg	Stowed for launch	TBD m
Mass of satellite in target orbit	TBD kg	Deployed on orbit	TBD m
<i>FINAL ORBIT</i>		<i>LIFETIME</i>	
Zp × Za × inclination; ω; RAAN		TBD years	
<i>PAYLOAD</i>			
TBD operational channels of TBD bandwidth			
Traveling wave tube amplifiers: TBD (if used)			
Transmit Frequency range: TBD W			
Receive Frequency range. TBD W			
EIRP: TBD			
<i>ANTENNAS (TM/TC)</i>			
Antenna direction and location			
<i>PROPULSION SUB-SYSTEM</i>			
Brief description: TBD (liquid, number of thrusters, used for orbit transfer and/or in orbit manoeuvres...)			
<i>ELECTRICAL POWER</i>			
Solar array description	(L × W)		
Beginning of life power	TBD W		
End of life power	TBD W		
Batteries description	TBD	(type, capacity)	
<i>ATTITUDE CONTROL</i>			
Type: TBD			
<i>STABILIZATION</i>			
Spin*			
3 axis*			
<i>COVERAGE ZONES OF THE SATELLITE</i>		TBD (figure)	

*Note: * to be selected.*

A1.2. Mission characteristics

A1.2.1. Orbit description

Orbit parameters and its dispersions:

	Separation orbit	Spacecraft final orbit (if different)
• Perigee altitude	_____ ± _____ km	_____ km
• Apogee altitude	_____ ± _____ km	_____ km
• Semi major axis	_____ ± _____ km	_____ km
• Eccentricity		
• Inclination	_____ ± _____ deg	_____ deg
• Argument of perigee	_____ ± _____ deg	_____ deg
• RAAN	_____ ± _____ deg	_____ deg

Orbit constraints

- Any element constrained by the spacecraft (injection time limitation, aerothermal flux, ground station visibility, etc.)

A1.2.2. Launch window(s) definitions

A1.2.2.1. Constraints and relevant margins

Targeted launch period/launch slot

Solar aspect angle, eclipse, ascending node, moon constraints, etc.

A1.2.2.2. Targeted window

The targeted launch window shall be computed using the reference time and reference orbit described in the User's Manual if any. The resulting launch window must include the dual launch window, when applicable, as specified in the User's Manual for any launch period. The launch window's data is preferably supplied as an electronic file (MS Excel). Constraints on opening and closing shall be identified and justified.

A1.2.3. Flight maneuvers and separation conditions

A1.2.3.1. Attitude control during flight and prior to separation

Any particular constraint that the spacecraft faces up to injection in the separation orbit should be indicated (solar aspect angle constraints, spin limitation due to gyro saturation or others).

Any particular constraint that the spacecraft faces after injection, during the Roll and Attitude Control System sequence prior to separation, should be indicated (solar aspect angle constraints or others).

A1.2.3.2. Separation conditions

A1.2.3.2.1. Separation mode and conditions

Indicate spinning (axial or transverse) or three-axis stabilization (tip-off rates, depointing, etc., including limits).

A1.2.3.2.2. Separation attitude

The desired orientation at separation should be specified by the customer with respect to the inertial perifocal reference frame [U, V, W] related to the orbit at injection time, as defined below:

U = radius vector with its origin at the center of the Earth, and passing through the intended orbit perigee.

V = vector perpendicular to U in the intended orbit plane, having the same direction as the perigee velocity.

W = vector perpendicular to U and V to form a direct trihedron (right-handed system [U, V, W]).

For circular orbits, the [U, V, W] frame is related to the orbit at a reference time (specified by Arianespace in relation with the mission characteristics) with U defined as radius vector with origin at the Earth center and passing through the launcher CoG (and V, W as defined above).

In case of 3-axis stabilized mode, two of the three S/C axes [U, V, W] coordinates should be specified. In case of spin stabilized mode, the S/C spin axes [U, V, W] coordinates should be specified.

Maximum acceptable angular rate and relative velocity at separation shall be indicated.

A1.2.3.3. Separation conditions and actual launch time

Need of adjustment of the separation attitude with regard to the actual launch time (relative to the sun position or other) should be indicated.

A1.2.3.4. Sequence of events after S/C separation

Describe main maneuvers from separation until final orbit including apogee firing schedule.

A1.3. Spacecraft description

A1.3.1. Spacecraft Systems of Axes

The S/C properties should be given in spacecraft axes with the origin of the axes at the separation plane.

Include a sketch showing the spacecraft system of axes, the axes are noted Xs, Ys, Zs and form a right handed set (s for spacecraft).

A1.3.2. Spacecraft geometry in the flight configuration

A drawing and a reproducible copy of the overall spacecraft geometry in flight configuration is required. It should indicate the exact locations of any equipment requiring access through shroud, lifting points locations and define the lifting device. Detailed dimensional data will be provided for the parts of the S/C closest to the "static envelope" under shroud (antenna reflectors, deployment mechanisms, solar array panels, thermal protections, etc.). It includes the static envelop drawing and adapter interface drawing.

Preferably, a 3D CAD model limited to 300Mo (IGES or STEP extension) shall be supplied.

A1.3.3. Fundamental modes

Indicate fundamental modes (lateral, longitudinal) of spacecraft hardmounted at interface.

A1.3.4. Mass properties

The data required are for the spacecraft after separation. If the adapter is supplied by the Customer, add also spacecraft in launch configuration with adapter, and adapter alone just after separation.

A1.3.4.1. Dynamic out of balance (if applicable)

Indicate the maximum dynamic out of balance in degrees.

A1.3.4.2. Angular momentum of rotating components

A1.3.4.3. MCI Properties

Element (i.e. s/c adapter)	Mass (kg)	C of G coordinates (mm)			Coefficients of inertia Matrix (kg. m ²)					
		X _G	Y _G	Z _G	I _{xx}	I _{yy}	I _{zz}	I _{xy} *	I _{yz} *	I _{zx} *
Tolerance					Min/Max	Min/Max	Min/Max	Min/Max	Min/Max	Min/Max

Notes: *CoG coordinates are given in S/C axes with their origin at the separation plane.*
Inertia matrix is calculated in S/C axes with origin of the axes at the Centre of Gravity and 1 g conditions.
The cross inertia terms () must be intended as the opposite of the inertia products (I_{xy} = -P_{xy}).*

A1.3.5. Propellant/pressurant characteristics

Tanks		1	2	3	4
Propellant		NTO	MMH	NTO	MMH
Density	(kg/m ³)				
Tank volume	(l)				
Fill factor	(%)				
Liquid volume	(l)				
Liquid mass	(kg)				
Centre of Gravity of propellant loaded tank	Xs				
	Ys				
	Zs				
Slosh model under 0 g	Pendulum mass	(kg)			
	Pendulum length	(m)			
	Pendulum attachment point	Xs			
		Ys			
		Zs			
	Fixed mass (if any)				
	Fixed mass attachment point (if any)	Xs			
		Ys			
		Zs			
Natural frequency of fundamental sloshing mode (Hz)					
Slosh model under 1 g	Pendulum mass	(kg)			
	Pendulum length	(m)			
	Pendulum attachment point	Xs			
		Ys			
		Zs			
	Fixed mass (if any)				
	Fixed mass attachment point (if any)	Xs			
		Ys			
		Zs			
Natural frequency of fundamental sloshing mode (Hz)					

		Pressurant helium			
		1	2	3	...
Tanks					
Volume	(l)				
Loaded mass	(kg)				
Centre of Gravity (mm)	Xs				
	Ys				
	Zs				

Indicate:

Mass of total pressurant gas: TBD kg

Number of pressurant tanks: TBD

A1.3.6. Mechanical Interfaces

A1.3.6.1. Customer using Arianespace standard adapters

A1.3.6.1.1. Interface geometry

Provide a drawing with detailed dimensions and nominal tolerances showing:

- the spacecraft interface ring,
- the area allocated for spring actuators and pushers,
- umbilical connector locations and supports,
- the area allocated for separation sensors (if any),
- equipment in close proximity to the separation clampband (superinsulation, plume shields, thrusters).

A1.3.6.1.2. Interface material description

For each spacecraft mating surface in contact with the launcher adapter and the clampband, indicate material, roughness, flatness, surface coating, rigidity (frame only), inertia and surface (frame only), and grounding.

A1.3.6.2. Customer providing its own adapter

Define the adapter and its interface with the launch vehicle according to Arianespace's specifications.

Define the characteristics of the separation system including:

- separation spring locations, type, diameter, free length, compressed length, spring constraint, energy,
- tolerances on the above,
- dispersion on spring energy vectors,
- dispersion of separation system,
- clampband tension,
- dispersion on pyro device actuation times,
- the energy of separation and the energy released in the umbilical connectors.

A1.3.6.3. Spacecraft accessibility requirements after encapsulation

Indicate items on the spacecraft to which access is required after encapsulation, and give their exact locations in spacecraft coordinates.

A1.3.7. Electrical interfaces

Provide the following:

- A spacecraft to EGSE links description and diagram as well as a definition of umbilical connectors and links (indicate voltage and current during launch preparation as well as at plug extraction).

The umbilical links at launch preparation:

S/C connector pin allocation number	Function	Max voltage (V)	Max current (mA)	Max voltage drop (ΔV)	or	Expected one way resistance (Ω)
1						
2						
3						
...						

The umbilical links at umbilical connector extraction (lift-off):

Function	Max voltage (V)	Max current (mA)

- A block diagram showing line functions on the spacecraft side and the EGSE side,
- Data link requirements on ground (baseband and data network) between spacecraft and EGSE,
- A description of additional links used after spacecraft mating on the L/V for the test or ground operation,
- The location of the spacecraft ground potential reference on the spacecraft interface frame,
- Electrical link requirements (data, power, etc.) during flight between the L/V and spacecraft.

A1.3.8. Radioelectrical interfaces

A1.3.8.1. Radio link requirements for ground operations

Provide the radio link requirements and descriptions between spacecraft, launch site, spacecraft check-out system and PPF and HPF (including re-rad).

Include transmit and receive points location of antenna(e) to be considered for radio links during launch preparation, as well as antenna(e) pattern.

A1.3.8.2. Spacecraft transmit and receive systems

Provide a description of spacecraft payload telecommunications systems (for information only)

Provide a description of spacecraft telemetry and telecommand housekeeping systems.

For each TM and TC system used on the ground and during launch, give the following:

Unit designation	Tx1			Tx2			Tx3	Rx1		
FUNCTION	TELEMETRY (Transfer orbit)						TELEMETRY (On station) ⁽¹⁾	TELECOMMAND		
Color code ⁽³⁾										
BAND										
CARRIER FREQUENCY F0 (MHz)										
BANDWIDTH	-3dB									
CENTERED AROUND	-20dB									
F0 (Mhz)	-60dB									
CARRIER MODULATION	Type									
	Index									
	Bit rate									
SUB CARRIER (Mhz)										
MINIMUM S/N (dB)										
ASSOCIATED BANDWIDTH (MHz)										
FIELD STRENGTH	MAX									
AT ANTENNA	NOM			-				-		
RECEIVE (dBW/m ²)	MIN									
RF OUTPUT IMPEDANCE (Ohm)										
Low Power mode available (Yes/No)										
Antenna designation	Horn +Z	Horn -Z	Omni	Horn +Z	Horn -Z	Omni	Comm Ant.	Horn +Z	Horn -Z	Omni
Color code ⁽³⁾										
ANTENNA LOCATION (mm)	X									
	Y									
	Z									
PATTERN										
GAIN MAX. (dBi)										
EIRP : output power (dBW) ⁽²⁾	MAX									
	NOM									
	MIN									
Antenna input power (dBW) ⁽²⁾	MAX									
	NOM									
	MIN									

(1) On station data not required if no RF tests are planned once S/C on the L/V.

(2) These data should come from RF test.

(3) Color code: light green represent the nominal flight configuration. Please refer to LS-SG-1000000-X-002-AE : general specification for radio compatibility analysis input for more explanation on the format.

If one channel is the backup of another one, it should be clearly indicated.

The spacecraft transmission plan shall also be supplied as shown in table below.

RF TRANSMISSION PLAN BEFORE D0						
Location ⇔	BAF-HE (upper payload only)		BAF-HC		Launch Pad	Remark
S/C sources ↓	Before encaps.	After encaps.	Lower S/C only: before upper comp. integr.	Upper comp. on L/V	D-1 after the BAF-ZL transfer	
S1						
S2...						

RF TRANSMISSION PLAN FROM D0					
Location ⇔	L/P	L/P & Flight	In orbit	In orbit	Remark
S/C sources ↓	Before H0-1h30	After H0-1h30 until 20s after sep.	In transfer orbit	On station	
S1					
S2					

Provide the spacecraft emission and the spacecraft susceptibility spectrum.

A1.3.8.3. Spacecraft ground station network

For each spacecraft ground station to be used for spacecraft acquisition after separation (nominal and back-up stations) indicate the geographical location (latitude, longitude, and altitude) and the radio-electrical horizon for TM and telecommand and associated spacecraft visibility requirements.

A1.3.9. Environmental characteristics

Provide the following:

- thermal and humidity requirements (including limits) of environment during launch preparation and flight phase,
- dissipated power under the fairing during ground operations and flight phase,
- maximum ascent depressurization rate and differential pressure,
- contamination constraints and contamination sensible surfaces,
- purging requirements (if any).

Indicate the following:

- specific EMC concerns (e.g. lightning, RF protection),
- spacecraft electrical field susceptibility levels,
- spacecraft sensitivity to magnetic fields (if any).

A1.4. Operational requirements

A1.4.1. Provisional range operations schedule

Provide a main operations list and description (including launch pad activities) and estimated timing (with hazardous operation identification).

A1.4.2. Facility requirements

For each facility used for spacecraft preparation (PPF, HPF, Launch pad) provide:

- main operations list and description,
- space needed for spacecraft , GSE and Customer offices,
- environmental requirements (Temperature, relative humidity, cleanliness),
- power requirements (Voltage, Amps, # phases, frequency, category),
- RF and hardline requirements,
- support equipment requirements,
- GSE and hazardous items storage requirements.

A1.4.3. Communication needs

For each facility used for spacecraft preparation (PPF, HPF, Launch pad) provide need in telephone, facsimile, data lines, time code, etc.

A1.4.4. Handling, dispatching and transportation needs

Provide

- estimated packing list (including heavy, large and non-standard container characteristics) with indication of designation, number, size (L x W x H in m) and mass (kg),
- a definition of the spacecraft container and associated handling device (constraints),
- a definition of the spacecraft lifting device including the definition of CCU interface (if provided by the Customer),
- a definition of spacecraft GSE (dimensions and interfaces required),
- dispatching list.

A1.4.5. Fluids and propellants needs

A1.4.5.1. List of fluids

Indicate type, quality, quantity and location for use of fluids to be supplied by Arianespace.

A1.4.5.2. Chemical and physical analysis to be performed on the range

Indicate for each analysis: type and specification.

A1.4.5.3. Safety garments needed for propellants loading

Indicate number.

A1.4.6. Technical support requirements

Indicate need for workshop, instrument calibration.

A1.4.7. Security requirements

Provide specific security requirements (access restriction, protected rooms, supervision, etc.).

A1.5. Miscellaneous

Provide any other specific requirements requested for the mission.

A1.6. Contents of the spacecraft development plan

The customer prepares a file containing all the documents necessary to assess the spacecraft development plan with regard to the compatibility with the launch vehicle.

It, at least, shall include:

- spacecraft test plan: define the qualification policy, vibrations, acoustics, shocks, protoflight or qualification model,
- requirements for test equipment (adapters, clamp-band volume simulator, etc.),
- tests on the customer's premises,
- test at the range.

A1.7. Definitions, acronyms, symbols

Provide a list of acronyms and symbols with their definition.

A1.8. Contents of Safety Submission Phases 1 and 2

The customer prepares a file containing all the documents necessary to inform CSG of his plans with respect to hazardous systems. This file contains a description of the hazardous systems. It responds to all questions on the hazardous items check list given in the document Payload Safety Handbook, and summarized here below.

Sheet number	Title
O	Documentation
GC	General comments. Miscellaneous
A2	Igniter assembly S & A device. Initiation command and control circuits
A3	GSE operations
B1	Electro-explosive devices ordnance
B2	Initiation command and control circuits
B3	GSE ground tests operations
C1	Monopropellant propulsion system
C2	Command and control circuits
C3	GSE operations
AC1	Dual propellant / propulsion system propellants
AC2	Command and control circuits
AC3	GSE operations
D1A	Non ionizing RF systems
D2A	Optical systems
D3A	Other RF sources laser systems
D1B	Electrical systems batteries heaters
D2B	Umbilical electrical interfaces
D3B	GSE battery operations
D1C	Pressurized systems with fluids and gas other than propellants cryogenics
D2C	Command and control circuits
D3C	GSE operations
D1D	Mechanical / electro-mechanical systems Transport / handling devices structure
D2D	Other systems and equipment
D1E	Ionizing systems / flight sources
D2E	Ionizing systems / ground sources

A1.9. Contents of Spacecraft Operations Plan (POS)

The customer defines the operations to be executed on the spacecraft from arrival at the CSG, at the launch site, and up to the launch.

A typical content is presented here below.

1. General

1.1 Introduction

1.2 Applicable documents

2. Management

2.1 Time schedule with technical constraints (day by day)

3. Personnel

3.1 Organizational chart for spacecraft operation team in campaign

3.2 Spacecraft organizational chart for countdown

4. Operations

4.1 Handling and transport requirements for spacecraft and ancillary equipment

4.2 Tasks sheets for every operations describing the operation and support needed, indicating any hazardous activity and including description of required access after encapsulation.

5. Equipment associated with the spacecraft

5.1 Brief description of equipment for launch operations

5.2 Description of hazardous equipment (with diagrams)

5.3 Description of special equipment (PPF, HPF, Launch table)

6. Installations

6.1 Surface areas including offices

6.2 Environmental requirements

6.3 Communications links (including RF)

7. Logistics

7.1 Transport facilities

7.2 Packing list

Reviews and documentation checklist

Annex 2

A2.1. Introduction

This annex presents the typical documentation and meetings checklist that is used as a base during contract preparation. The delivery dates will be modified according to the customer's mission schedule, availability of the input data and spacecraft's production planning.

The dates are given in months, relative to contract kick-off meeting or relative to L, where L is the first day of the latest agreed launch period, slot, or approved launch day as applicable.

A2.2. Arianespace issued documentation

On a typical 24 months working baseline.

Ref.	Document	Date	Customer action ❶	Remarks
1	Interface Control Document (DCI): Issue 0	L -20	R	
	Issue 1, rev 0	L -16	A	after RAMP
	Updating of issue 1	as necessary	A	
	Issue 2, rev 0	L -2	A	after RAMF
2	Preliminary mission analysis documents	L -17.5	R	at RAMP
3	Final mission analysis documents	L -3	R	
4	Interleaved operations plan (POI)	L -2.5	R	at RAMF/OPS
5	Combined operations Plan (POC)	L - 2	A	Draft at RAMF/OPS
6	Countdown sequence	L - 2 weeks	R	
7	Safety statements: Phase 1 & 2 replies	3 months after each submission to be closed during launch campaign	R	
	Phase 3 reply		R	
8	Injection data (orbital parameters and attitude data prior to separation)	30 min after separation	I	
9	Launch evaluation document (DEL)	❷	I	

❶ A ⇒ Approval R ⇒ Review I ⇒ Information

❷ 1.5 months after launch, or 1 month after receipt of the orbital tracking report from the customer, whichever is later.

A2.3. Customer issued documentation

On a typical 24 months working baseline.

Ref.	Document	Date	Arianespace action ❶
1	Application to use Arianespace L/V (DUA) or spacecraft interface requirements document (IRD)	L - 22	R
2	Safety submission Phase 1 and 2	L - 20 to L-9	A
3	S/C dynamic model (preliminary) according to A5-SG-0-01	L - 20	R
4	S/C mechanical environment test plan	L - 20	A
5	S/C thermal model according to LS-SG-1-X-26-AE ❷	L - 12	R
6.1	Preliminary S/C Launch Operations Plan (POS)	L - 10	R
6.2	S/C Launch Campaign planning	L - 4	R
7	S/C dynamic model (final) according to A5-SG-0-01❷	L - 6	R
8	Updated S/C data for final mission analysis ❷	L - 6	R
9	S/C operations procedures applicable at CSG, including Safety submission Phase 3	L - 6	A
10	Environmental testing: instrumentation plan, notching plan, test prediction for sine test according to LS-SG-1000000-X-001-AE	❷	A
11	Environmental Testing: Instrumentation plan, test plan for Acoustic test according to LS-SG-1000000-X-001-AE	❷	A
12	S/C final launch window	L-2.5	R
13	S/C mechanical environment tests results according to LS-SG-1000000-X-001-AE	❸	A
14	Launch campaign containers Packing List	❹	R
1	Final S/C mass properties ❺	❻	R
16	Orbital tracking report (orbit parameters and S/C attitude after separation)	2 weeks after launch	I

❶ A ⇒ Approval; R ⇒ Review; I ⇒ Information

❷ 1 month before S/C tests

❸ 1 month after S/C tests ❹ At the latest two weeks before the start of the launch campaign

❺ Including S/C wet mass, S/C dry mass, propellant mass break down

❻ Before beginning of POC Operations

❼ Customer shall provide those models and data no later than the dates mentioned in the table. In the event that following those dates, customer provides Arianespace with any modification leading to the need of re-performance by Arianespace of the analysis, then customer shall bear the responsibility and may be invoiced for any associated cost.

A2.4. Meetings and reviews

Mtg	Title	Date ①	Subjects ②	Location ③
1	Contractual kick-off meeting	L -24	M-E	C
2	DUA review Review of S/C characteristics and requirements	L -20	M-E-O-S	E or W
3	Preliminary Mission analysis kick off: First DCI review issue 0 rev 0 Presentation of Ariane mission analysis computation and method	L -20	M-E	E or W
4	Prelim. mission analysis review [RAMP] Trajectory, performance and injection accuracy- separation and collision avoidance- dynamic environment - EMC environment Safety submission status DCI review	L -17	M-E-O-S	E
5	DCI signature issue 1 rev0	L -16	M-E-O-S	④
6	Preparation of S/C operations plan [POS]- if required: Launch base facilities visit - CSG support - telecommunication network - Safety submission phase 1 and 2 DCI review (chapters 7 and 8)	L -12	M-O-S	W or K
7	Security Review - if required	L-12	M-O	K
8	Review of S/C operations plan [POS] Transport and logistics - Preliminary satellite Operation plan (POS) - combined operations introduction - telecommunication network Safety submission phase 1 and 2 DCI review (chapters 7 and 8)	L -6	M-O-S	W
9	Final Mission Analysis Kick-Off: Review of the inputs for the Final Mission Analysis DCI review	L -6	M-E	⑦
10	Final mission analysis review [RAMF] DCI review	L -2.5	M-E	E
11	Campaign preparation: final meeting	L -2.5	M-O-S	E

12	DCI signature issue 2 rev 0	L-2	M	⑥
13	VIP launch preparation meeting	L-2	M	C
14	Range configuration review	④	M-O-S	K
15	POC readiness review (BT POC)	⑤	M-O-S	K
16	Technical wash-up meeting	L-1 day	O	K
17	Financial Wrap-up meeting	L-1 day	M	K

① Meeting target dates are given, taking into account the respective commitments of both parties for the delivery of the documentation as described in this annex parts 2 & 3. Dates are given in months, relative to L, where L is the first day of the latest agreed Launch Term, Period, Slot or Day, as applicable.

② M ⇨ Management; E ⇨ Engineering; O ⇨ Operations; S ⇨ Safety

③ E ⇨ Evry; K ⇨ Kourou; C ⇨ CUSTOMER HQ; W ⇨ Contractor Plant

④ To be held at Spacecraft Team arrival in Kourou

⑤ To be held the day before the agreed day for starting the Combined Operations

⑥ To be combined with another meeting or to be performed by electronic exchange

⑦ To be combined with another meeting or to be performed by teleconference

Items and services for an Arianespace launch

Annex 3

Within the framework of the Launch Service Agreement Arianespace supplies standard items and conduct standard services.

In addition, Arianespace proposes a tailored service, the General Range Service (GRS), to suit the needs of satellite operations during the launch campaign at CSG.

Other items and services, to cover specific customer's requirements, are additionally provided as options through the Launch Service Agreement or ordered separately.

A3.1. Mission management

Arianespace will provide a dedicated mission organization and resources to fulfill its contractual obligations in order to satisfy the customer's requirements, focusing on the success of the mission: contract amendments, payments, planning, configuration control, documentation, reviews, meetings, and so on ... as described in the chapter 7.

A3.2. System engineering support

A3.2.1. Interface management

DCI issue, update and configuration control.

A3.2.2. Mission analysis

Arianespace will perform the Mission Analyses as defined in chapter 7 in number and nature.

A3.2.3. Spacecraft Compatibility Verification

Reviewing and approbation of the spacecraft compatibility with the L/V through the documentation provided by the customer (test results, qualification files...).

A3.2.4. Post-launch analysis

Injection parameters (S/C orbit and attitude data).

Flight synthesis report (DEL).

A3.3. Launch vehicle procurement and adaptation

Arianespace will supply the hardware and software to carry out the mission, complying with the launch specification and the Interface Control Document (DCI):

- one equipped Ariane 5 launch vehicle, in shared or single launch configuration,
- one dedicated flight program,
- launch vehicle propellants,
- one payload compartment under the fairing, on or inside a dual launch carrying structure*,
- one mission logo installed on the fairing and based on the Customer artwork supplied at L-6,
- one adapter with separation system, umbilical interface connector, umbilical harnesses, and instrumentation,
- two Check-Out Terminal Equipment (COTE) racks compatible with the Ariane 5 launch table.

* access door(s) and passive repeater or RF window are available as options

A3.4. Launch operations

Arianespace shall provide:

- all needed launch vehicle autonomous preparation (integration, verification and installation, etc.)
- launch vehicle/spacecraft combined operations,
- launch pad operations including countdown and launch,
- flight monitoring, tracking and reporting.

A3.5. Safety assurance

As defined in chapter 7.

A3.6. Quality assurance

As defined in chapter 7.

A3.7. General Range Support (GRS)

The General Range Support provides the customer, on a lump sum basis, with a number of standard services and standard quantities of fluids (see list hereafter). Request(s) for additional services and/or supply of additional items exceeding the scope of the GRS can be accommodated, subject to negotiation between Arianespace and the customer.

A3.7.1. Transport Services

A3.7.1.1. Personnel transportation

Transport from and to Félix Eboué Airport and Kourou at arrival and departure.

A3.7.1.2. Spacecraft and GSE transport between airport or harbor and PPF

Subject to advanced notice and performed nominally within normal CSG working hours. Availability outside normal working hours, Saturdays, Sundays and public holidays is subject to advance notice, negotiations and agreement with local authorities.

It includes:

- Coordination of loading / unloading activities,
- Transportation from Félix Eboué airport and/or Degrad-des-Cannes harbor to CSG and return to airport / harbor of spacecraft and associated equipment of various freight categories (standard, hazardous, fragile, oversized loads, low speed drive, etc...) compliant with transportation rules and schedule for oversized loads. The freight is limited to 12 x 20 ft pallets (or equivalent) in 2 batches (plane or vessel),
- Depalletisation of spacecraft support equipment on arrival to CSG, Palletisation of spacecraft support equipment prior to departure from CSG to airport/harbor,
- All formality associated with the delivery of freight by the carrier at airport/harbor,
- CSG support for the installation and removal of the spacecraft check-out equipment.

It does not include:

- the "octroi de mer" tax on equipment permanently imported to Guiana, if any,
- insurance for spacecraft and its associated equipment.

A3.7.1.3. Logistics support

Support for shipment and customs procedures for the spacecraft and its associated equipment and for personal luggage and equipment transported as accompanied luggage.

A3.7.1.4. Spacecraft and GSE Inter-Site Transportation

All spacecraft transportation either inside the S/C container or in the Ariane payload container (CCU), and spacecraft GSE transportation between CSG facilities.

A3.7.2. Payload preparation facilities allocation

The Payload Preparation Complex, with its personnel for support and equipped as described in the EPCU User's Manual, may be used simultaneously by several customers.

Specific facilities are dedicated to the Customer on the following basis: activities performed nominally within normal CSG working hours, or subject to negotiations and agreement of authorities, as defined in chapter 6.4 "CSG operations policy".

PPF and HPF areas

- spacecraft preparation (clean room) 350 m²
- lab for check-out stations (LBC) 110 m²
- offices and meeting rooms 250 m²
- filling hall dedicated

Storage

Any storage of equipment during the campaign.

Propellant storage provided for a duration starting 2 months before the launch campaign until one month after the launch campaign.

Schedule restrictions

The launch campaign duration is limited to 15 working days, from S/C arrival in French Guiana, to actual spacecraft hand over to Arianespace for the start of the combined Operations. Extension possible, subject to negotiations.

Spacecraft Ground Support Equipment must be ready to leave the range within 3 working days after the launch.

After Spacecraft transfer to the filling hall, and upon request by ARIANESPACE, the Payload Processing Facility (PPF) may be used by another Customer. The evacuation of Ground Support Equipment (GSE) from the clean room shall thus be completed within 1 working day after departure of the Spacecraft to the filling hall. In the same way, the evacuation of the GSE from the filling hall shall also be completed within 1 working day after departure of the Spacecraft for the Combined Operations.

A3.7.3. Communication Links

The following communication services between the different spacecraft preparation facilities will be provided for the duration of a standard campaign (including technical assistance for connection, validation and permanent monitoring).

Service	Type	Remarks
RF- Link	S/C/Ku/Ka band	1 TM / 1 TC through optical fiber
Baseband Link	analogic / digital	2 TM / 2 TC through optical fiber
Data Link	Romulus Network, V11 and V24	For COTE monitoring & remote control
Ethernet	Planet network, 100Mb/sec	
Umbilical Link	Copper lines	2x37 pins for S/C umbilical & 2x37 pins for auxiliary equipment.
Internet	ADSL	3 points of access with associated routers ②
Closed Circuit TV		As necessary
Intercom System		As necessary
Paging System		5 beepers ②
CSG Telephone		As necessary
Cellular phone	GSM	Rental by Customer
International Telephone Links ①	With Access Code	As necessary
ISDN (RNIS) links ①	Subscribed by CSG	As necessary. Routed to dedicated Customer's working zone
Facsimile in offices ①		1 ②
Video Conference ①	Equipment shared with other Customers	As necessary

Note: ① Traffic to be paid, at cost, on CSG invoice after the campaign

② To be shared between the Customer and its subcontractors

A3.7.4. Cleanliness monitoring

Continuous monitoring of particulate and organic deposits in clean room, with one report per week.

Continuous counting of particles in clean room, with one report per week.

A3.7.5. Operation

One mechanical and/or electrical adapter fit check at S/C arrival in Kourou if not performed before.

A3.7.6. Fluid and Gases Deliveries

Gases	Type	Quantity
Compressed air	Industrial, dedicated local network	6bar. As necessary
GN2	N50, dedicated local network and/or B50 bottles	As necessary available at 190 bar
GHe	N55, dedicated local network and/or bottles	As necessary, available at 350 bar and 200 bar; other pressure may be available on request.

Fluid	Type	Quantity
LN2	N30, local production	As necessary
IPA	MOS-SELECTIPUR	Up to 5 drums of 200l
Water	De-mineralized	Up to 5 drums of 200l

Note: Any requirement different from the standard fluid delivery (different fluid specification or specific use) is subject to negotiation.

A3.7.7. Safety

Equipment	Type	Quantity
Safety equipment for hazardous operations (Safety belts, gloves, shoes, gas masks, oxygen detection devices, propellant leak detectors, etc.)	Standard	As necessary

A3.7.8. Miscellaneous

One CD-ROM or DVD with launch coverage will be provided after the launch.

Office equipment:

- no-break power: 10 UPS 1.4 kVA at S1 or S5 offices for Customer PCs,
- copy machines: 2 in S1 or S5 Area (1 for secretarial duties, 1 for extensive reproduction); paper provided.

A3.8. Optional items and services

The following Optional items and Services list is an abstract of the "Tailored and optional services list" available for the customer and which is updated on a yearly basis.

A3.8.1. Launch vehicle hardware

- pyrotechnic command,
- electrical command,
- dry loop command,
- spacecraft GN₂ flushing,
- RF transmission through the payload compartment (either SRP or RF window),
- access doors: at authorized locations, for access to the encapsulated spacecraft.

A3.8.2. Mission analysis

Any additional Mission Analysis study or additional Flight Program requested or due to any change induced by the Customer.

A3.8.3. Interface tests

Note: any loan or purchase of equipment (adapter, clamp-band, bolts, separation pyro set) can be envisaged and is subject to previous test plan acceptance by Arianespace.

- fit-check (mechanical/electrical) with flight hardware in Kourou (optional if already performed in customer premises)
- fit-check (mechanical/electrical) with ground test hardware and one shock test (clamp-band release test) at customer's premises.

A3.8.4. Range Operations

- additional shipment of S/C support equipment from Cayenne to CSG and return,
- extra working shift,
- campaign extension above contractual duration,
- chemical analysis (gas, fluids and propellants except Xenon),
- S/C weighing,
- bilingual secretary,
- technical photos,
- transmission of TV launch coverage to the point of reception requested by the Customer,
- internet video corner during the spacecraft campaign,
- on board camera.

A3.8.5. Launch system visibility

See details in paragraph 7.7.2.

Ariane 5 ECA description

Annex 4



Ariane 5 ECA comprises two main sections :

- the lower section, consisting of the main cryogenic core stage (EPC) and the two solid propellant boosters (EAP),
- the upper section consisting of the upper composite (UC), including the upper stage (ESC-A) and the Vehicle Equipment Bay (VEB), and on top the payload composite.

MAIN CRYOGENIC STAGE (EPC)

The EPC stage is 5.4 m in diameter and 31 m long. It is powered by one Vulcain 2 engine that burns liquid hydrogen (LH₂) and liquid oxygen (LO₂) stored in two tanks separated with a common bulkhead. The LO₂ tank is pressurized by gaseous helium and the LH₂ one by a part of gaseous hydrogen coming from the regenerative circuit.

The Vulcain 2 engine develops 1,390 kN maximum thrust in vacuum. Its nozzle is gimballed for pitch and yaw control. The engine is turbopumped and regeneratively cooled. The thrust chamber is fed by two independent turbopumps using a single gas generator.

A cluster of GH₂ thrusters is used for roll control.



Ignition of the engine is obtained by pyrotechnic igniters and occurs 9 seconds before lift-off in order to check its good functioning.

The engine shut down command is sent by the On Board Computer (OBC) when the launcher has reached a pre-defined orbit or when a critical level of depletion of one of the propellant tanks has been reached.

SOLID PROPELLANT BOOSTER (EAP)

Each booster develops a maximum of 7,000 kN of thrust (in vacuum conditions) and is 3 m in diameter and 27 m long. Most of the launcher thrust at lift-off is provided by the two boosters (92%). The nozzles are gimballed by hydraulic actuators. The boosters are ignited just after the Vulcain proper functioning checks and they are jettisoned when the On Board Computer (OBC) detects thrust tail-off.



UPPER COMPOSITE (UC)

• LOWER PART - CRYOGENIC UPPER STAGE (ESC-A)

The ESC-A stage is 5.4 m in diameter and 4.8 m long between the I/F rings. It is powered by the HM7B engine that burns liquid hydrogen (LH₂) and liquid oxygen (LO₂) stored in two fully separated tanks. The LO₂ tank is pressurized by gaseous helium and the LH₂ one by a part of gaseous hydrogen coming from the regenerative circuit.



The HM7B engine develops 67 kN maximum thrust in vacuum. The engine is turbopump-fed and regeneratively cooled. The thrust chamber is fed by two pumps (LH₂ and LO₂) driven by a gas generator, a common turbine and a gear box.

During the powered flight, the attitude control in pitch and yaw is ensured by the gimbaling of the nozzle, and 4 GH₂ thrusters are used for roll control.

During the ballistic phase, roll, pitch and yaw control uses 2 clusters of 3 GH₂ thrusters. 2 GO₂ thrusters are also implemented for longitudinal boosts.

The engine shut down command is sent by the On Board Computer (OBC) when the launcher has reached a pre-defined orbit or when the OBC detects a thrust tail-off on depletion.

• UPPER PART - VEHICLE EQUIPMENT BAY (VEB)



All guidance, stage sequencing, telemetry, tracking and safety systems are supported by the VEB. In addition to separation commands, the spacecraft could be provided with additional commands (electrical or pyrotechnic), power and data transmission to the ground. Two redundant ring laser gyroscopes ensure inertial reference and guidance.



PAYLOAD COMPOSITE

• FAIRING

The payload fairing consists of two large composite half shells whose inside surfaces are covered with acoustic attenuation panels. This acoustic protection is used to absorb noise generated by the engines mainly during the lift-off event.

The payload fairing has an external diameter of 5.4 m and a total height of 17 m.

In order to increase the volume available for the S/C, a fairing raising cylinder can be used. Please contact Arianespace for any more information on this structure use.



• DUAL LAUNCH SYSTEM

In the dual launch configuration, the SYLDA 5 carrying structure is used:

The standard SYLDA 5 composite structure consists of a rear conical part of 0.6 m, a cylinder height of 3.2 m and another conical part (height 1.1 m) reaching a total height of 4.9 m, with a usable internal diameter volume of 4 m. The cylinder can be extended by up to 1.5 m in steps of 0.3 m. An additional version with a cylinder extension of 2.1 m is also contemplated. The total height can then reach 7 m.

• CONE 3936 or LVA 3936

The cone 3936 or LVA 3936 is an adaptation structure between the VEB upper frame ($\varnothing 3936$) and the lower frame of the Ariane 5 standard adaptors (respectively $\varnothing 2624$ or $\varnothing 1780$). Cone 3936 is 783mm high and LVA3936 is 1187 mm high. They are composed of a carbon structure and 2 aluminium rings. They both comprise a membrane, which separate the satellite compartment from the upper stage. It is designed to prevent helium transfer upper part compartment to satellite compartment.



• ADAPTERS

Payload adapters, generally of conical shape, ensure interfaces between the launcher and the spacecraft.

They consist of

- a conical or a cylindrical structure with
- an upper interface (937, 1194, 1663, 1666 and 2624mm) compatible with the spacecraft
- a bottom bolted interface ($\varnothing 1780$ mm or $\varnothing 2624$ mm)
- a separation system (generally a clamp-band) with springs to meet spacecraft separation requirements; a four-bolt separation system is also available for the 1663 interface
- an electrical system (connectors, microswitches...) including satellite umbilical lines and vibration sensors

Usable volume under fairing and SYLDA 5

Annex 5

The free volume available to the payload, known as the "static volume", is shown in the following figures.

This volume constitutes the limits that the static dimensions of the spacecraft, including manufacturing tolerance, thermal protection installation, appendices..., may not exceed.

It has been established having regard to the frequency requirements of para. 4.2.3.4. Allowance has been made for the flexibility of fairing, SYLDA 5 and of the spacecraft.

If needed, the compatibility of the spacecraft critical dimensions with the usable volume will be studied in greater depth by coupled load analysis, based on detailed information provided by the customer.

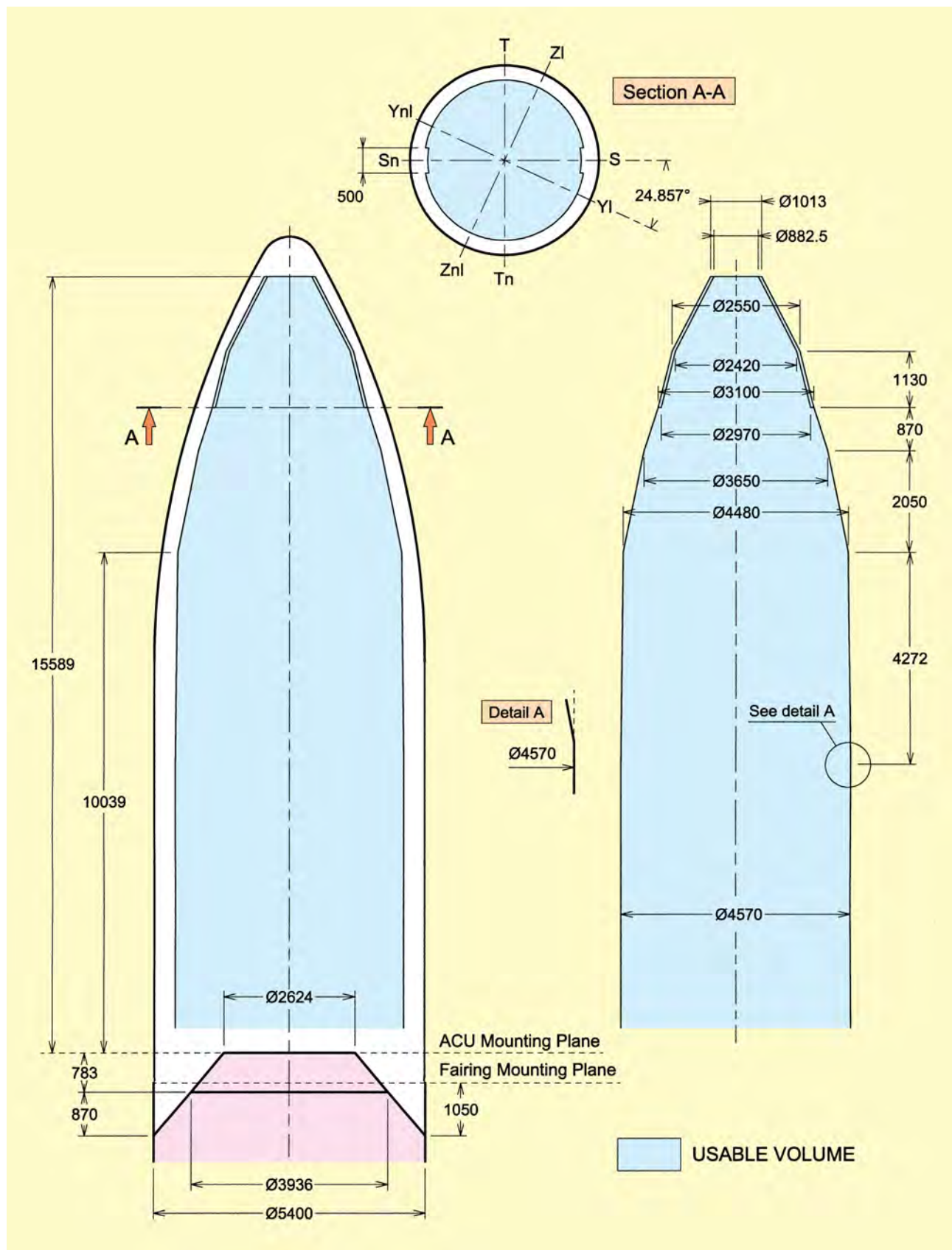
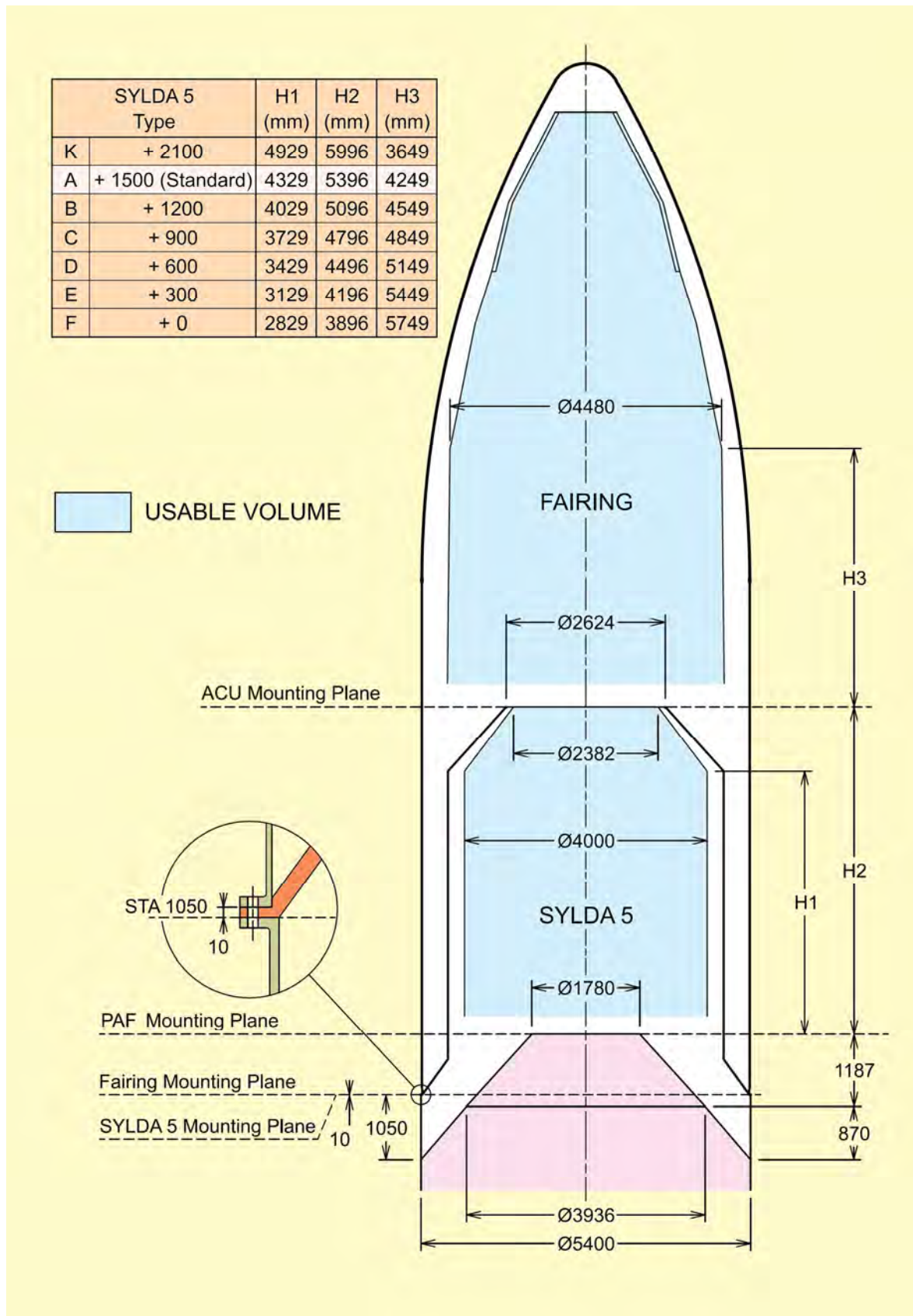

Figure A5.1 – Usable volume beneath the payload fairing



Spacecraft accessibility and radio communications

Annex 6

The following figures present the authorized areas and the associated main constraints for:

- the access doors in the fairing
- the access holes in the SYLDA5 (their position will be optimised to align correctly with the fairing doors)
- the radio frequency transparent windows in the fairing and the SYLDA 5
- the passive repeater system inside the fairing

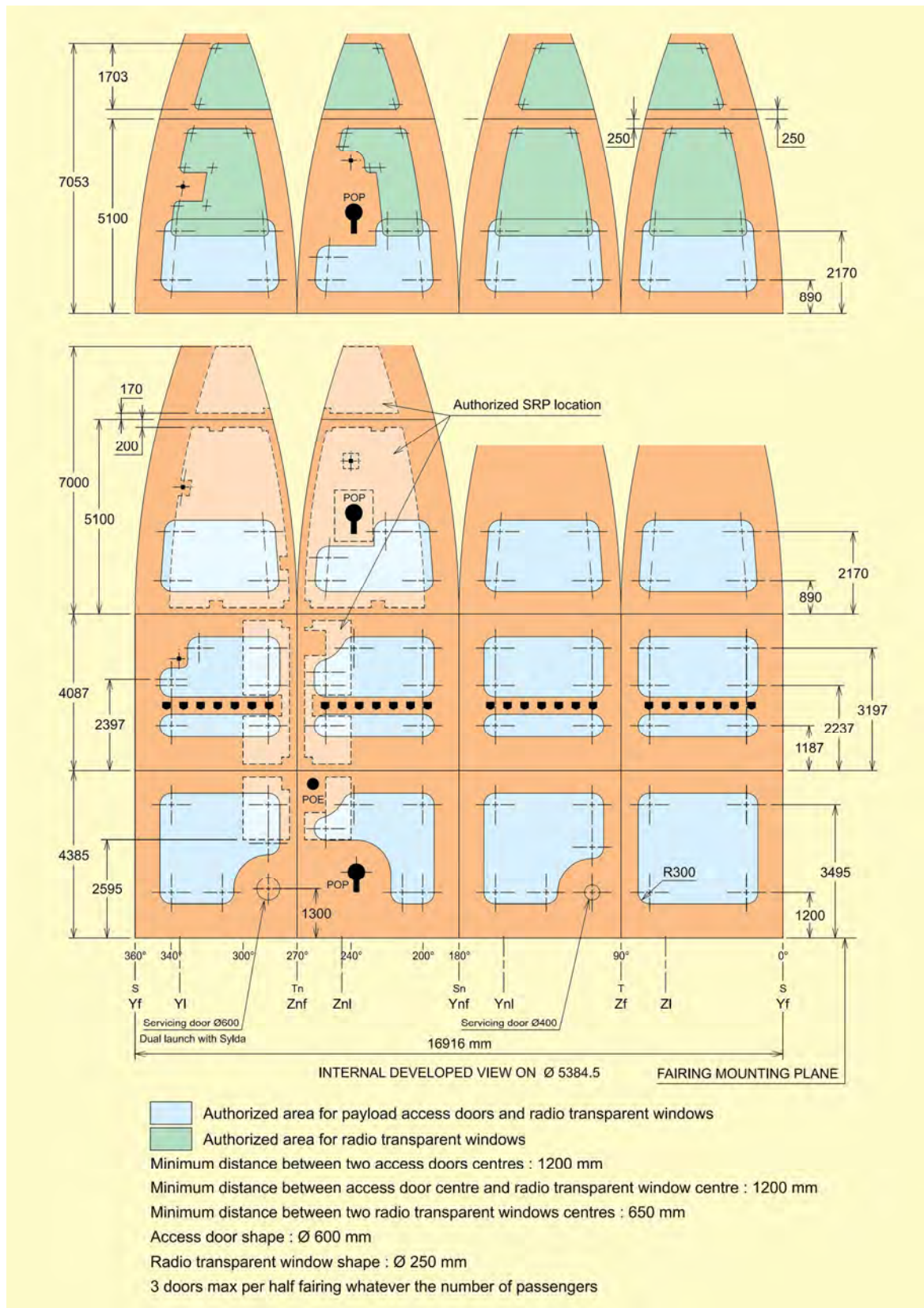

Figure A6.1– Fairing: locations and dimensions of access doors and RF windows, and authorized areas for SRP

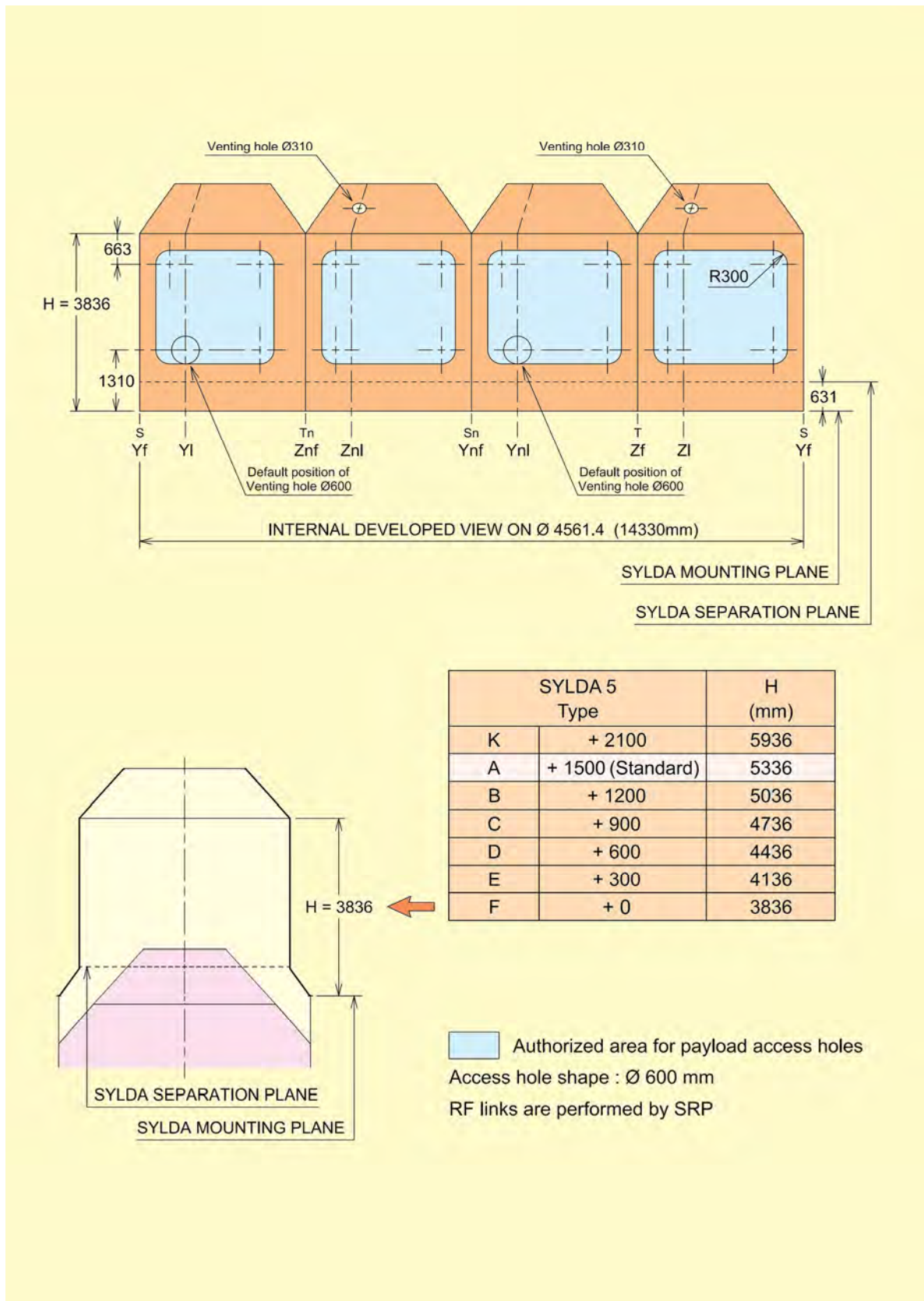

Figure A6.2– SYLDA 5: locations and dimensions of access holes

Nota : If more volume is requested, Arianespace can offer solutions including a raising cylinder. Please contact Arianespace for more information.

Adapter Ø937mm

Annex 7

There are two Payload Adapter Systems having the 937 mm spacecraft interface diameter, both equivalent in performance and in particular for the shock spectrum of the clamp-band release (see figure A7.1).

The maximum mass of the adapter system is 155 kg.

The PAS 937 is designed and qualified to support a payload of 4000 kg centred at 1500 mm from the separation plane.

For this qualification domain, the clamping tension may go up to 48 kN at any time, for the nominal pretension case of 40 kN. For further information regarding other pretension cases and its particular application domain please contact Arianespace.

The spacecraft is forced away from the launch vehicle by 4 actuators, bearing on supports fixed to the spacecraft rear frame.

The force exerted on the spacecraft by each spring does not exceed 1500 N.

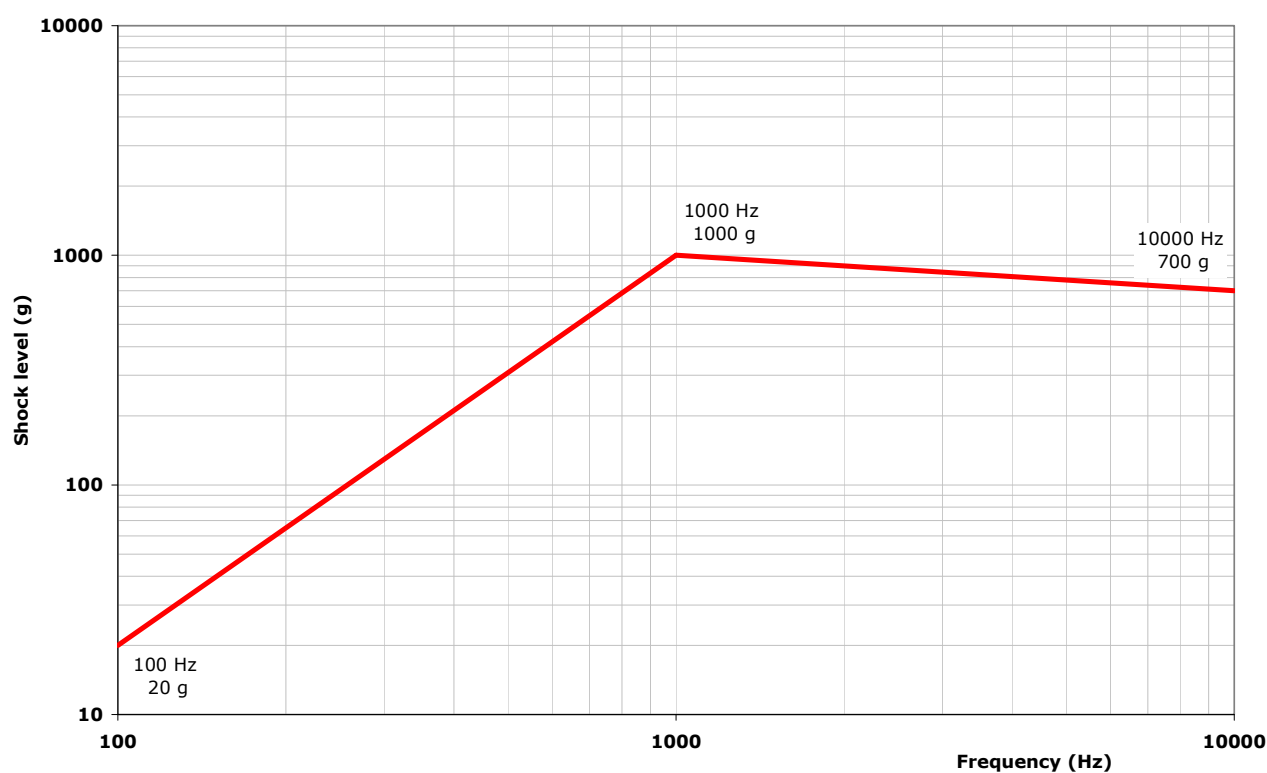

Figure A7.1 – Adapter 937 – Shock spectrum of clamp band release

PAS 937

PAS 937S

The PAS 937S is mainly composed of:

- a structure,
- a clamping device,
- a set of 4 actuators

The PAS 937S structure comprises the following main parts:

- the optional composite lower cone called LVA 2624 (Launch Vehicle Adaptor) bolted to the reference plane $\varnothing 2624$ (top of SYLDA or top of cone 3936) the monolithic aluminium upper cone called PAF (Payload Attachment Fitting), integrated on top of the LVA 2624 or LVA 3936 ($\varnothing 1780$), with a diameter of 937 mm at the level of the spacecraft separation plane,
- optionally, an intermediate metallic ring (ACY 1780) for specific accommodations needs.

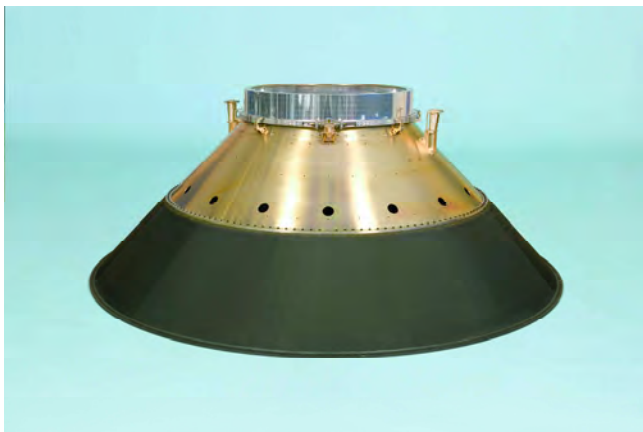

The spacecraft is secured to the adapter interface frame by a clamping device. The clamp band consists of a band with one connecting point. The tension applied to the band provides pressure on the clamp which attaches the satellite to the launcher. Release is obtained thanks to a Clamp Band Opening Device (CBOD) pyrotechnically initiated. The CBOD is specially designed to generate low shock levels. Finally a set of catchers secures a safe behaviour and parks the clamp band on the adapter.

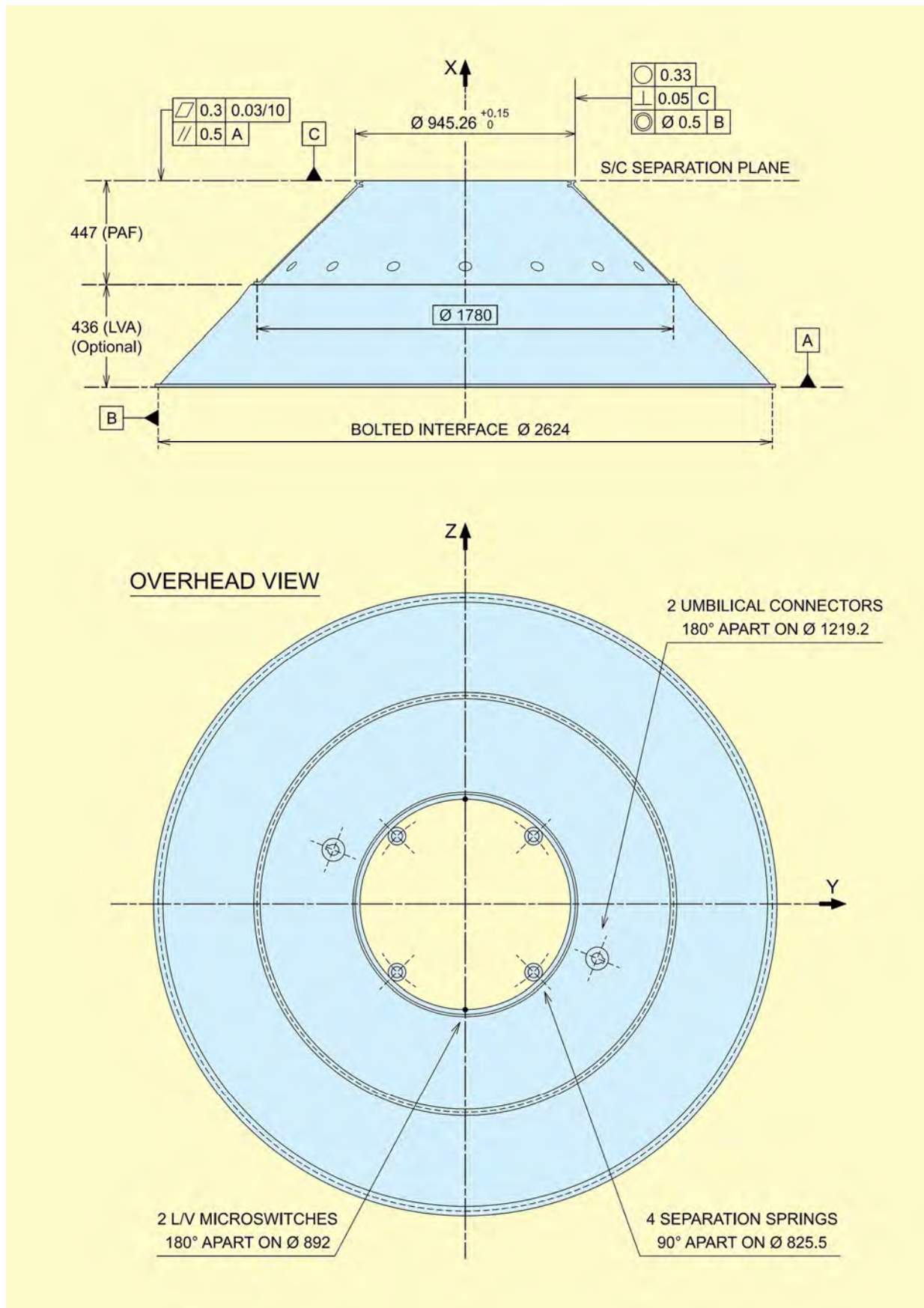

Figure A7.2 – PAS 937S – General View

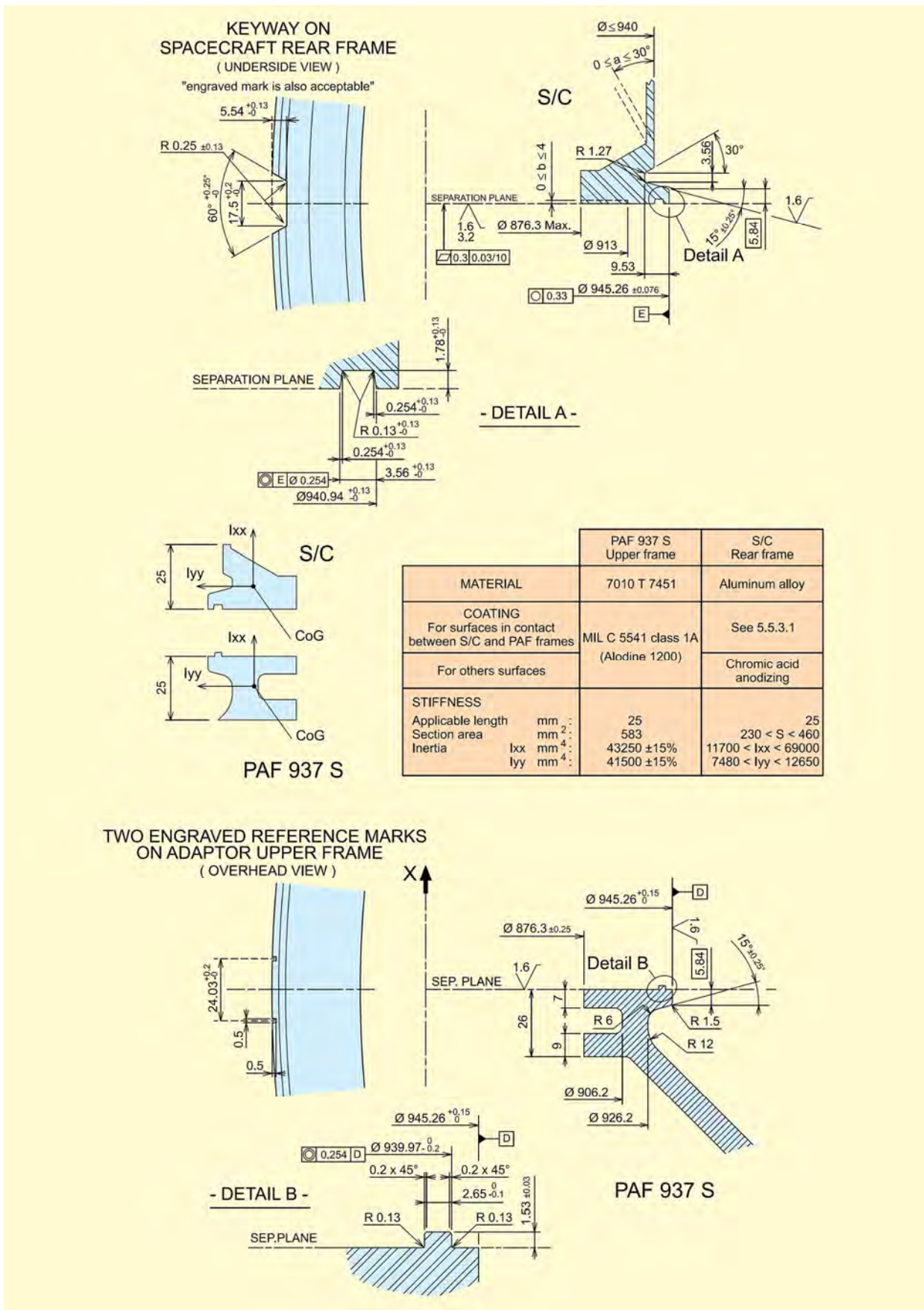

Figure A7.3 – PAS 937S – Interface Frames

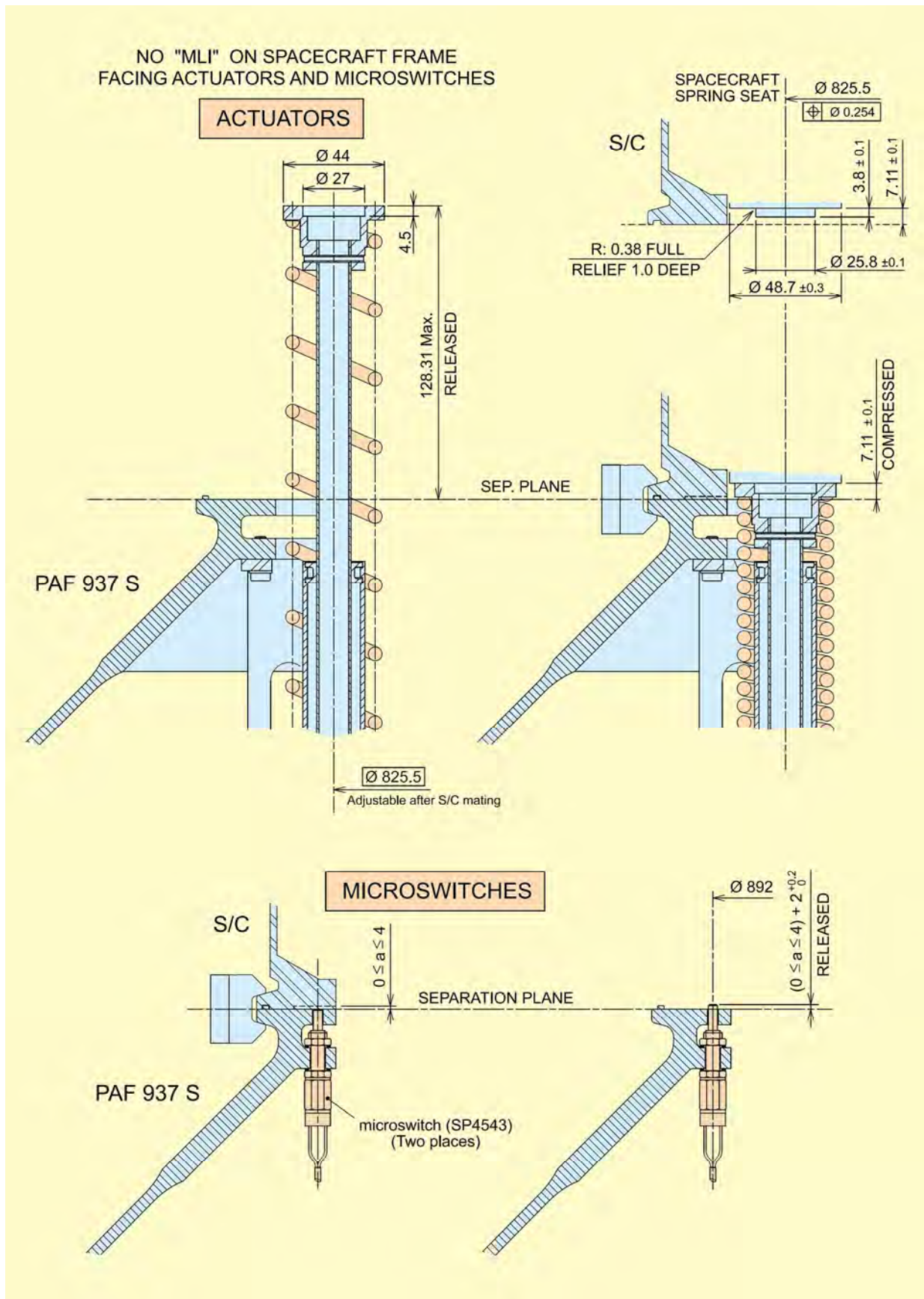

Figure A7.4 – PAS 937S – Actuators and microswitches

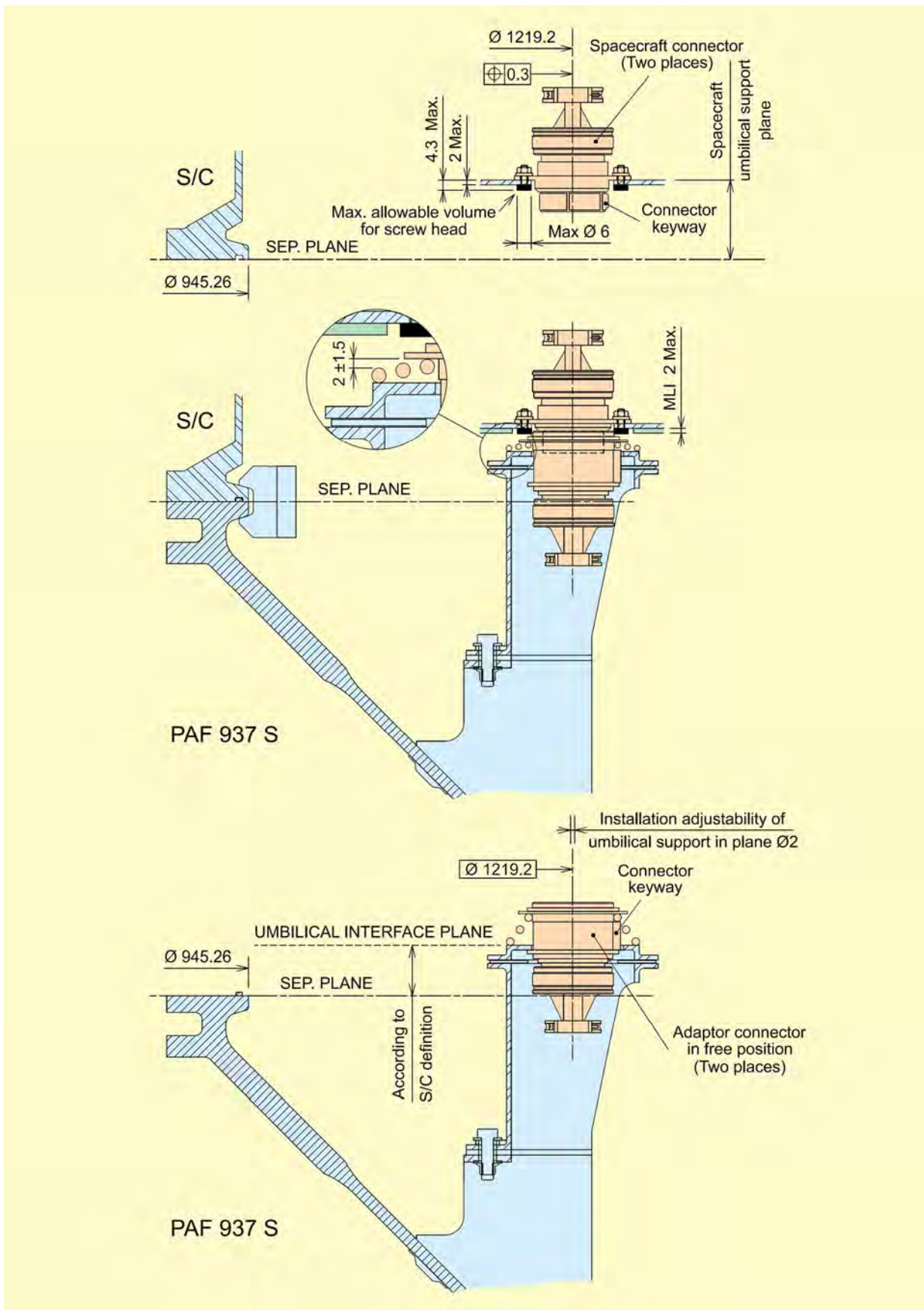

Figure A7.5 – PAS 937S – Umbilical connectors

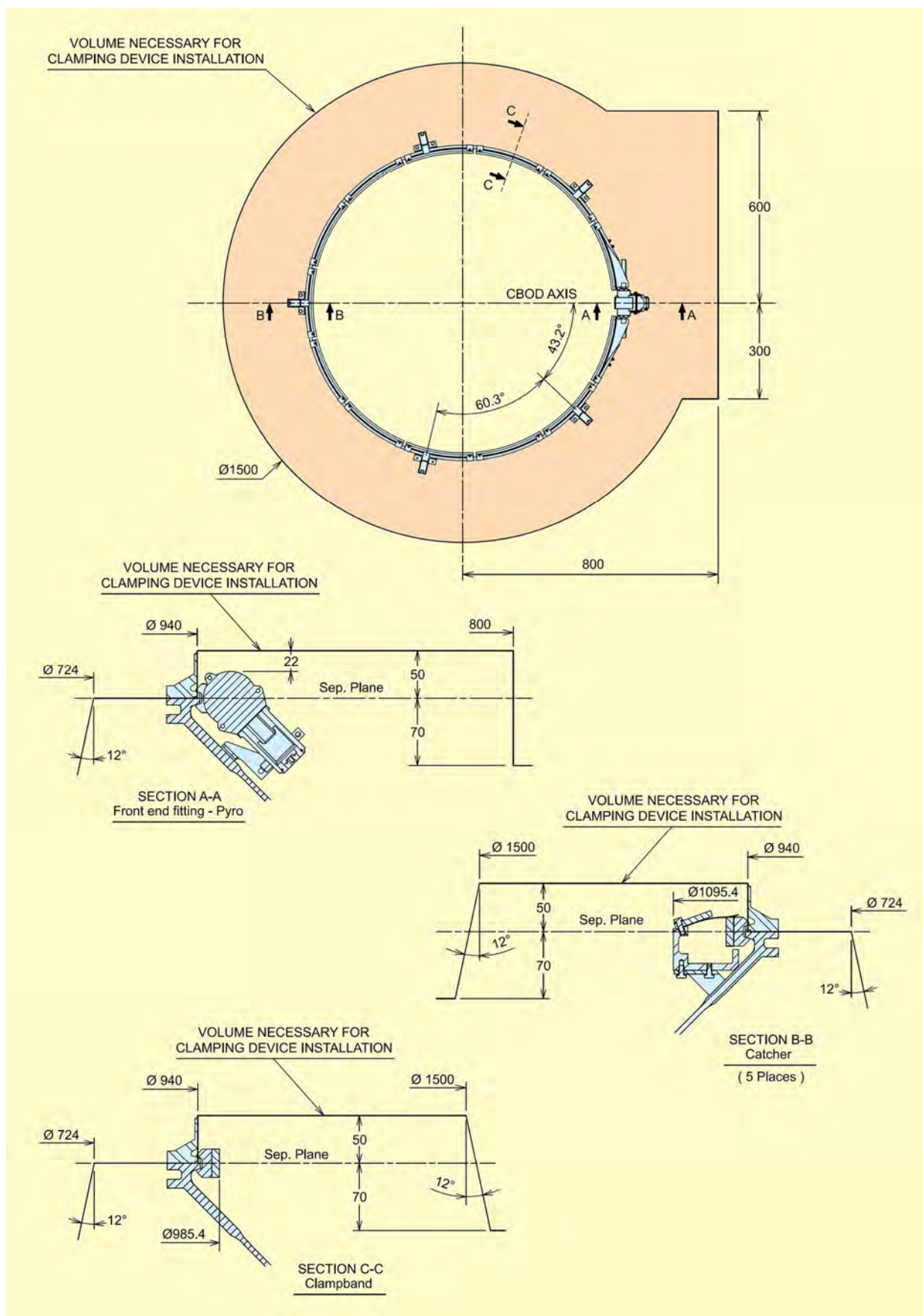

Figure A7.6 – PAS 937S – Clamping device interface

PAS 937

PAS 937C

The PAS 937C is mainly composed of:

- a load carrying structure,
- a separation and ejection subsystem,
- and an electrical subsystem.

The PAS 937C exists in 2 versions.

The PAS 937C baseline version is bolted to the reference plane $\varnothing 2624$ (top of SYLDA or top of cone 3936) and comprises the following main parts:

- a monolithic CFRP conical shell with an integrated lower ring at 2624 I/F, made by co-bonding technology,
- an aluminium alloy upper interface frame, integrated on top of the cone, with a diameter of 937 mm at the level of the spacecraft separation plane.



The PAS 937C variant A is divided in two elements which are named PAF 937 and LVA 2624:

- the PAF (Payload Adapter Fitting) 937 is a metallic structure with a 937mm diameter interface at its top and a 1780mm diameter bolted interface at its bottom. This interface can be bolted on top of LVA (Launch Vehicle Adapter) 2624 or LVA 3936.
- the optional LVA 2624 is designed to fit the diameter $\varnothing 1780$ at its upper end and the $\varnothing 2624$ bolted launch vehicle interface at its lower end (top of the SYLDA interface or cone 3936), and its structure is identical to the lower part of the PAS 937C with an aluminium upper ring,
- optionally, an intermediate Raising Cylinder (ACY 1780) with 1780 mm I/F diameter, ensuring sufficient gap between spacecraft lower protrusions and the adapter structure.

The spacecraft is secured to the adapter interface frame by a clamping device, the shock-less LPSS* (Launcher Payload Separation System) 937.

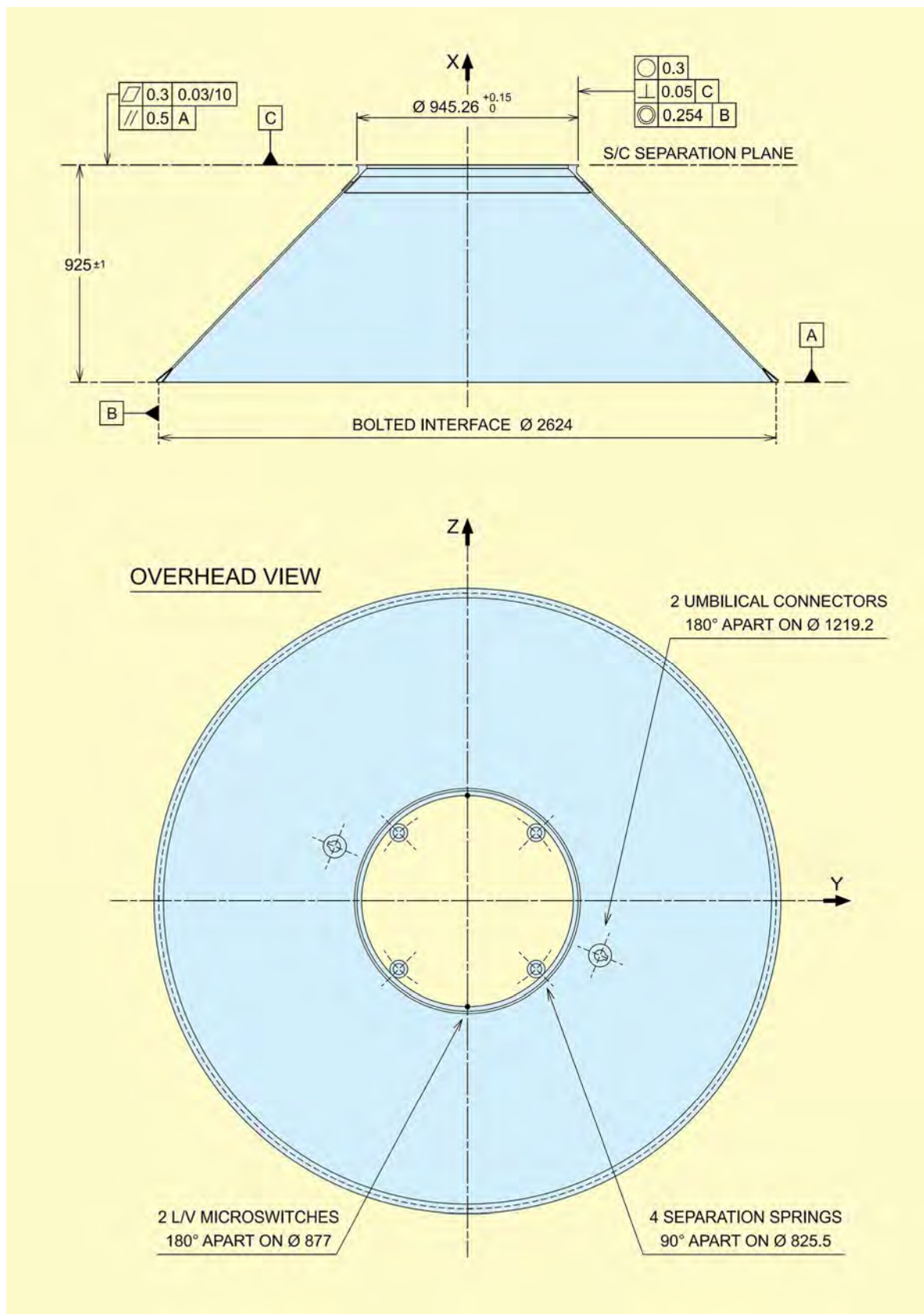

Figure A7.7 – PAS 937C– General view

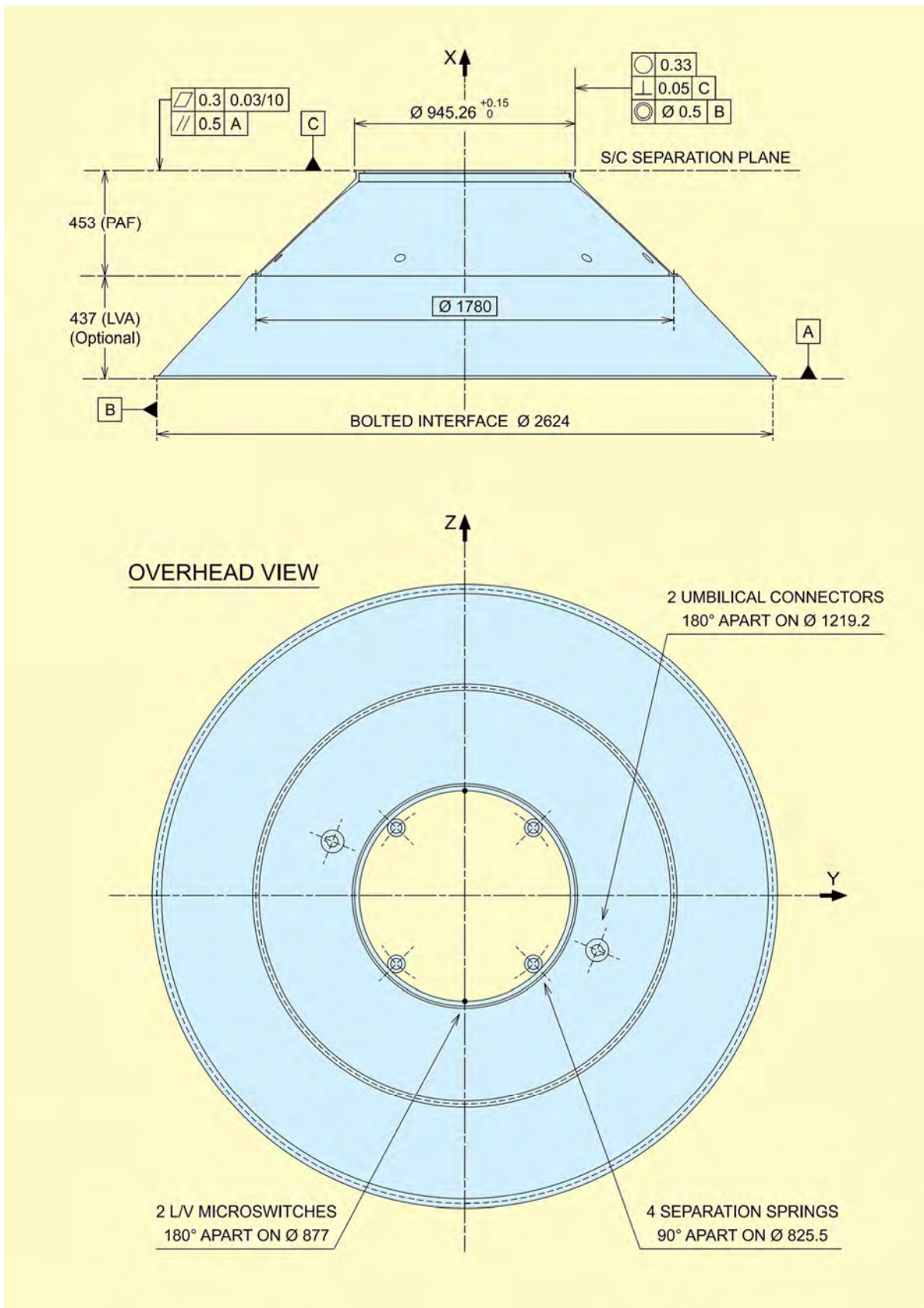

Figure A7.8 – PAS 937C Variant A – General view

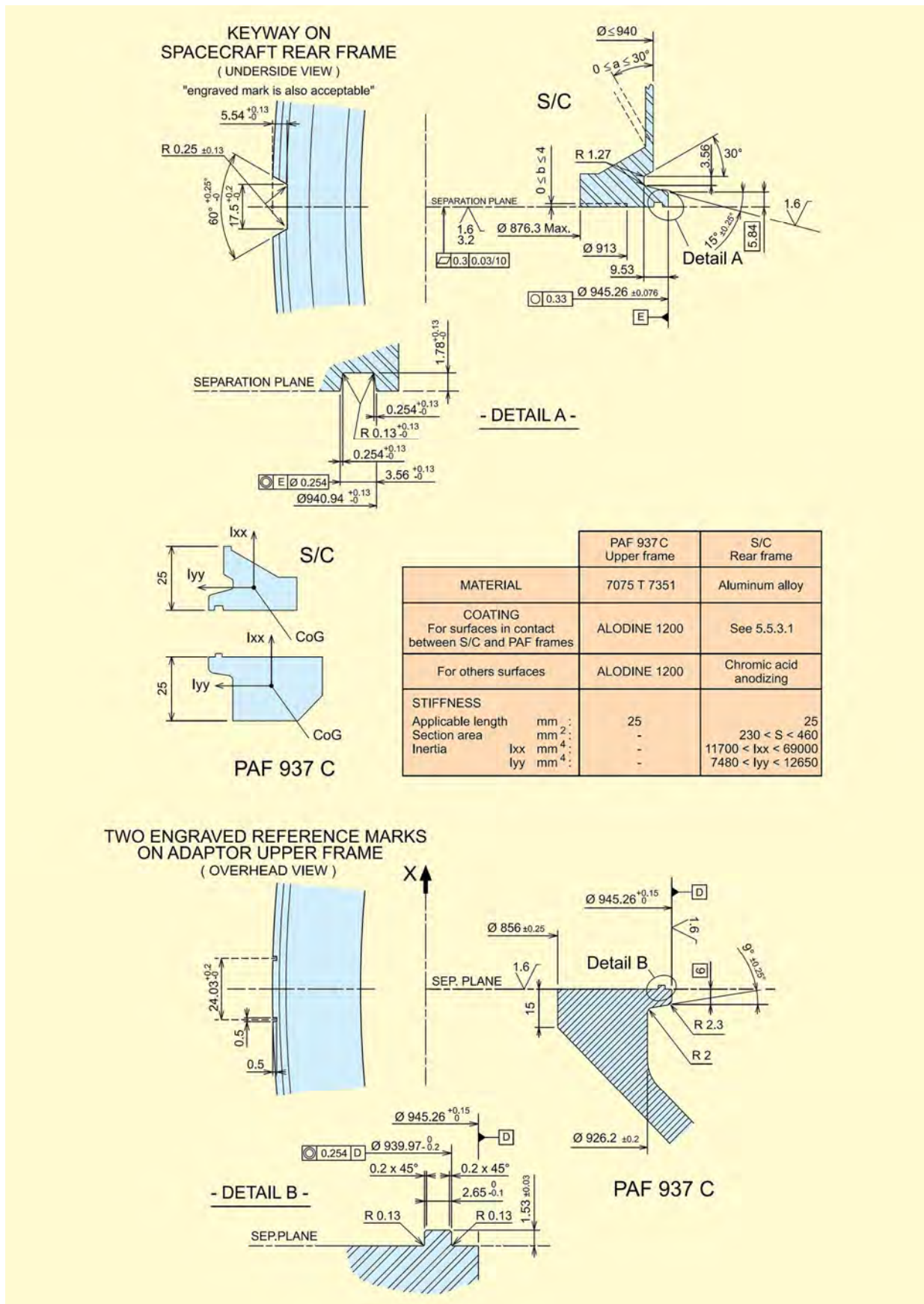

Figure A7.9 – PAS 937C – Interface frames

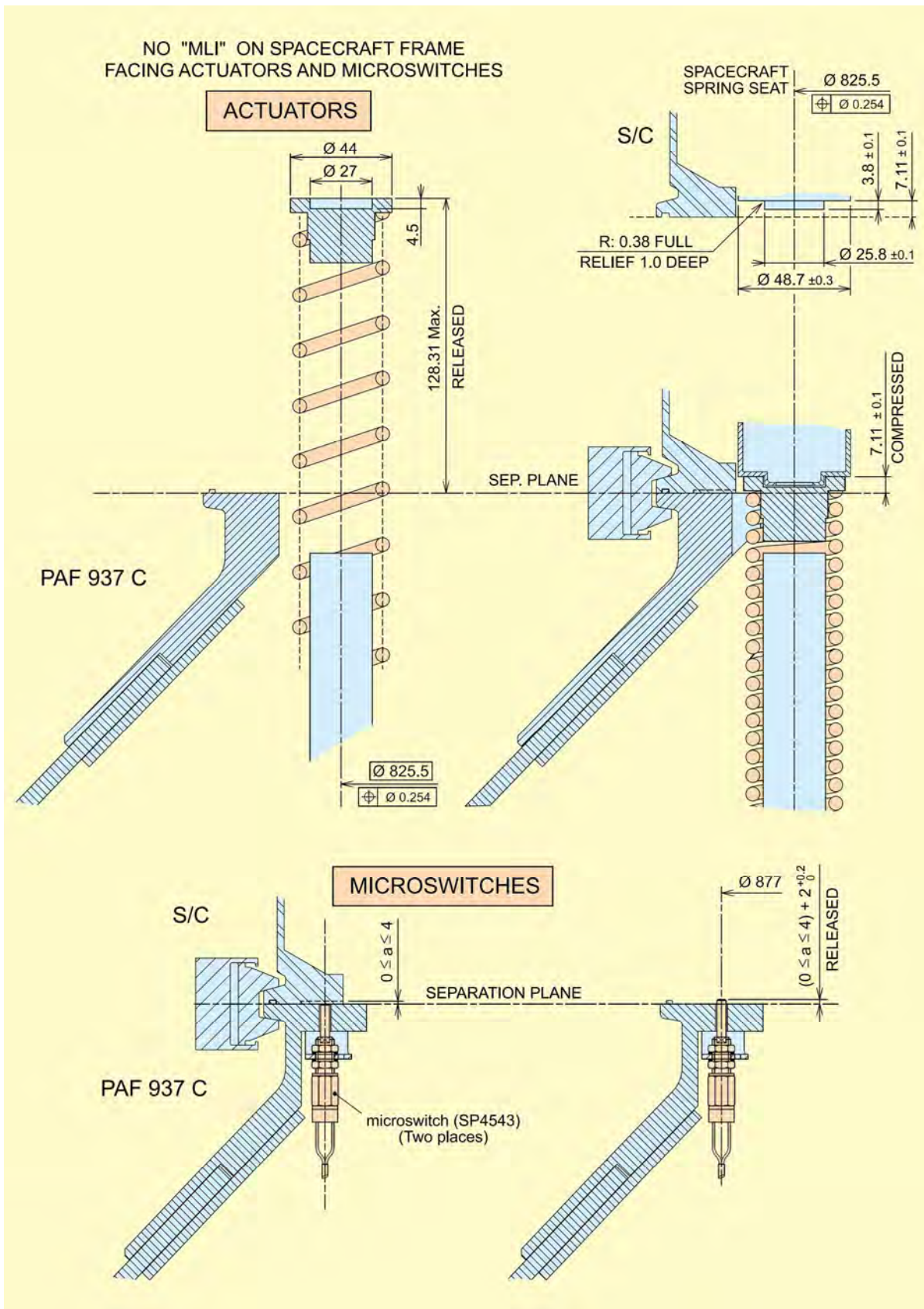

Figure A7.10 – PAS 937C – Actuators and microswitches

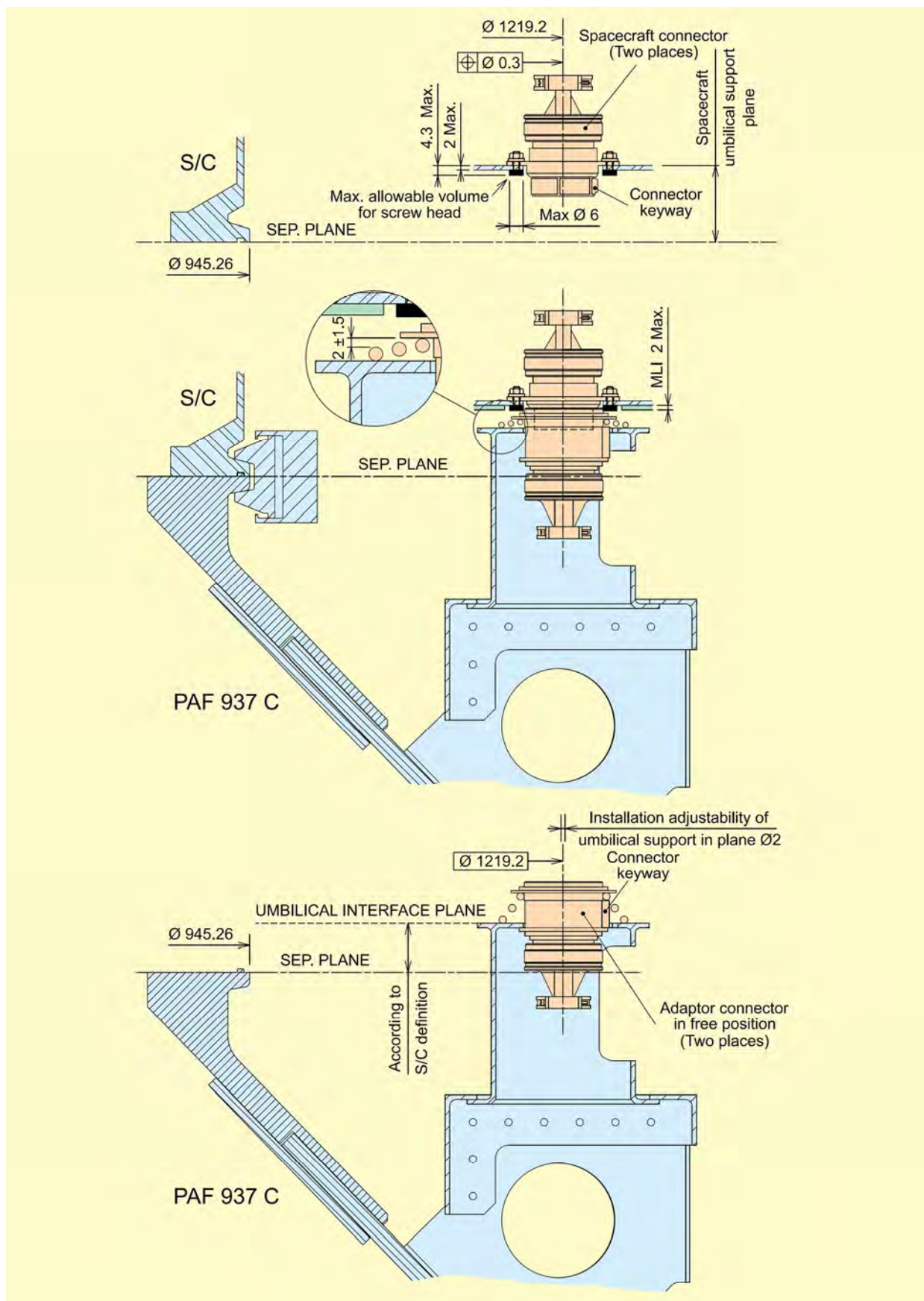

Figure A7.11 – PAS 937C – Umbilical connectors

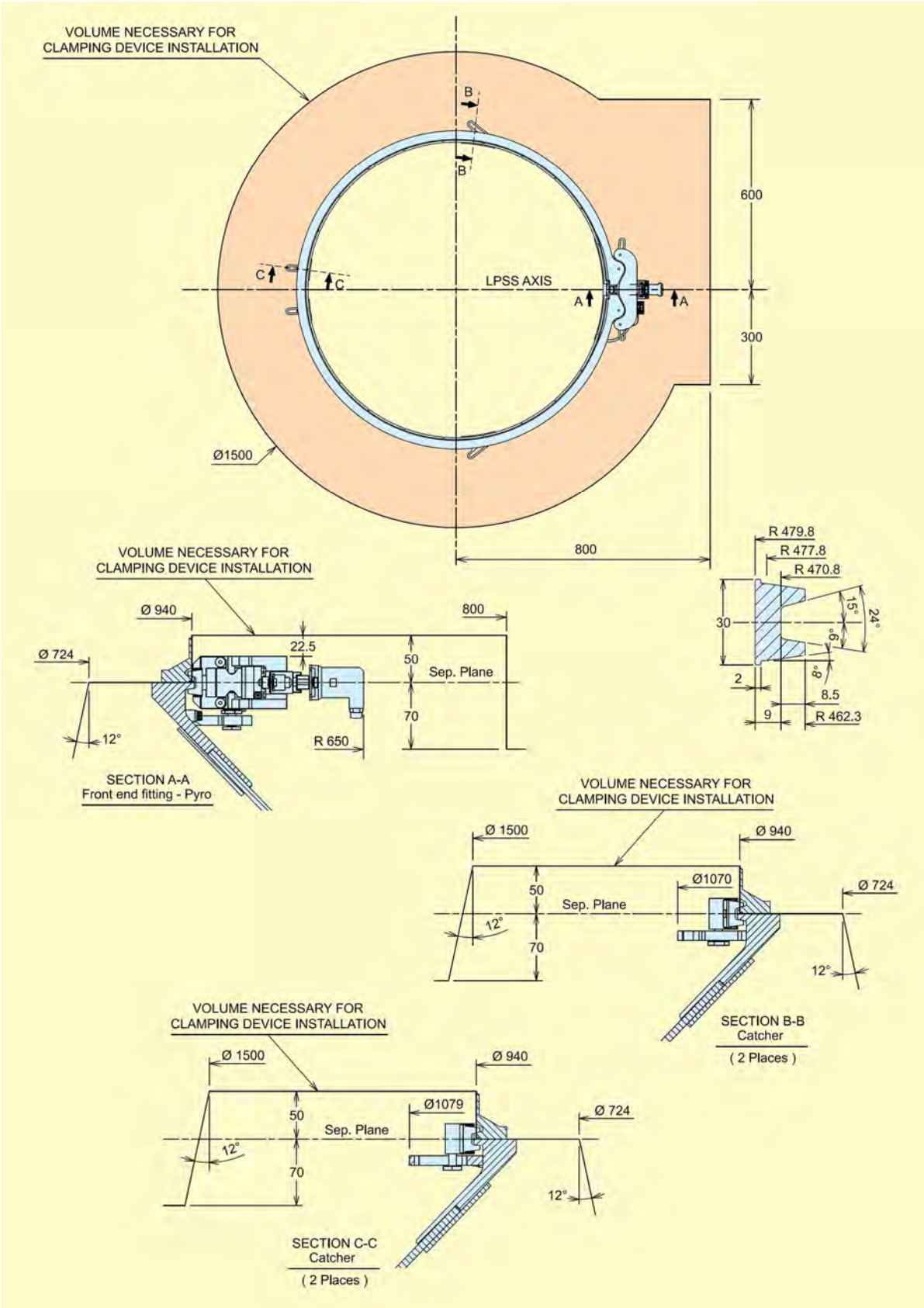

Figure A7.12 – PAS 937C – Clamping device interface

- USABLE VOLUME FOR 937 mm DIAMETER ADAPTERS -

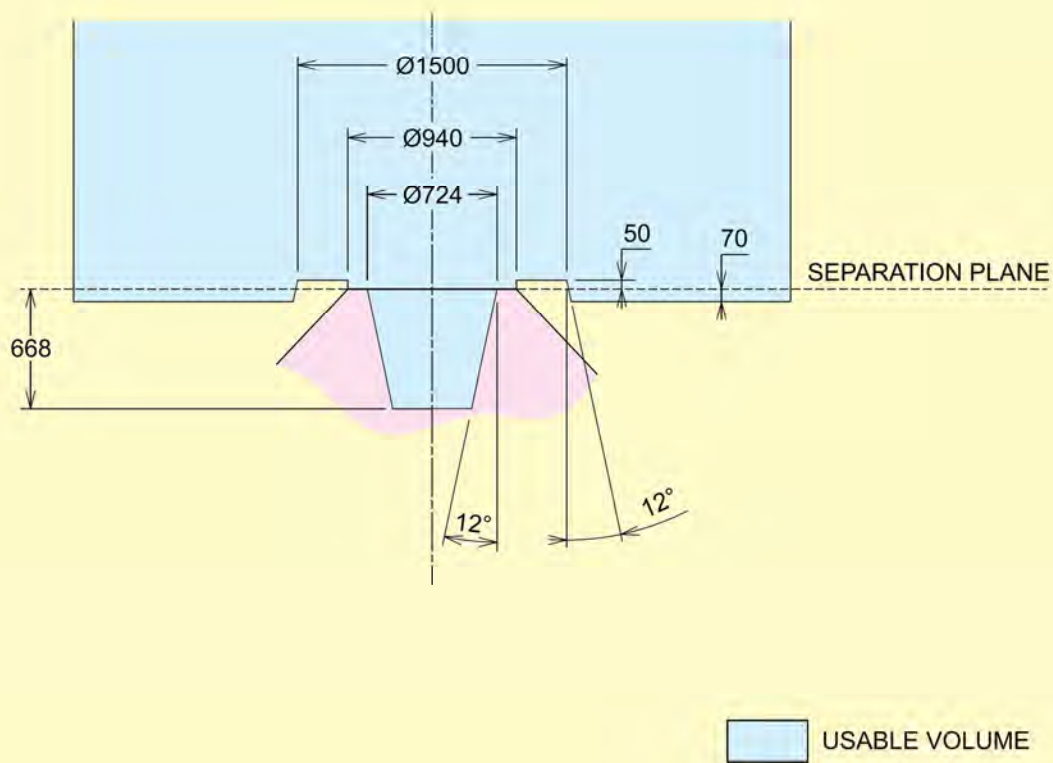

Figure A7.13 – Adapter 937mm Usable volume

Adapter Ø1194mm

Annex 8

There are two standard adapters having the 1194 mm spacecraft interface diameter, both equivalent in performance and in particular for the shock spectrum of the clamp-band release (see figure A8.1).

The maximum mass of these standard adapters is 150 kg.

These 1194mm adapters are designed and qualified to support a payload of 7000 kg centred at 2400 mm from the separation plane.

For this qualification domain, the clamping tension may go up to 72 kN at any time, for the nominal pretension case of 60 kN. For further information regarding other pretension cases and its particular application domain please contact Arianespace.

The spacecraft is pushed away from the launch vehicle by a series of 4 to 12 actuators, bearing on supports fixed to the spacecraft rear frame.

The force exerted on the spacecraft by each spring does not exceed 1500 N.

For specific missions, 2 other 1194mm diameter adapters are in development process.

One is a lighter PAF, PAF 1194VS-VL (Very Light), for spacecraft up to 4500kg centred at 1800mm. The other one is an adapter with a reduced height, PAS 1194VS-L (Low), for spacecraft up to 4000kg centred at 1800mm.

Both these adapters have the same clampband system and the same mechanical and electrical interfaces as the ones described below. For more information on these adapters, please contact Arianespace.

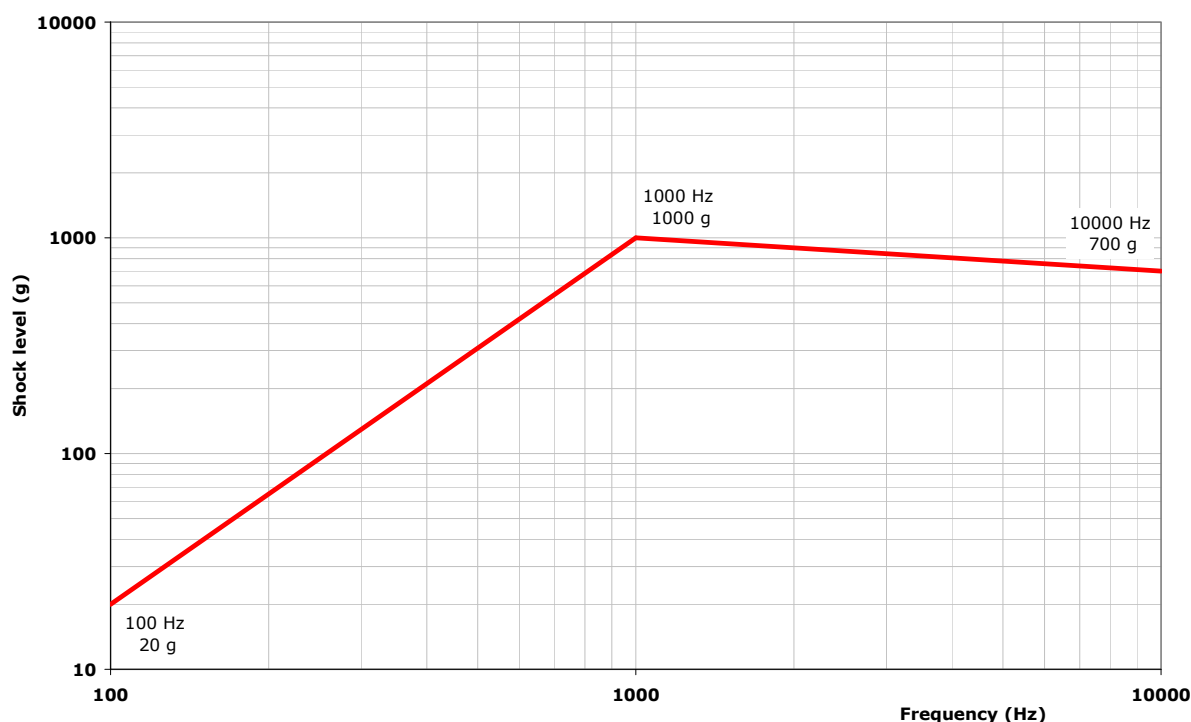

Figure A8.1 – PAS 1194 – Shock spectrum of clamp band release

PAS 1194

PAS 1194VS

The PAS 1194VS is mainly composed of:

- a structure,
- a clamping device,
- a set of 4 to 12 actuators.

The PAS 1194VS structure comprises the following main parts:

- The monolithic aluminium upper cone called PAF (Payload Attachment Fitting), integrated on top of the LVA 2624 cone or on top of LVA 3936 ($\text{\O}1780$) with a diameter of 1215 mm at the level of the spacecraft separation plane,
- The optional composite lower cone called LVA 2624 (Launch Vehicle Adapter) bolted to the reference plane $\text{\O}2624$ (top of SYLDA or top of cone 3936). This part is not used in case of lower position on top of LVA 3936.
- Optionally, an intermediate metallic ring for specific accommodations needs (ACY 1780).

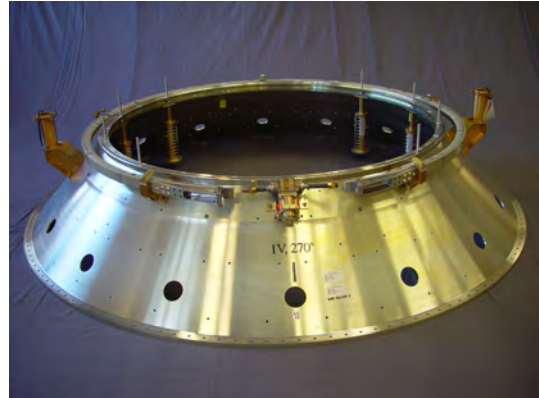

The spacecraft is secured to the adapter interface frame by a clamping device. The clamp band consists of a band with one connecting point. The tension applied to the band provides pressure on the clamp which attaches the satellite to the launcher. Release is obtained by means of a Clamp Band Opening Device (CBOD) pyrotechnically initiated. The CBOD is specially designed to generate low shock levels. Finally a set of catchers secures a safe behaviour and parks the clamp band on the adapter.



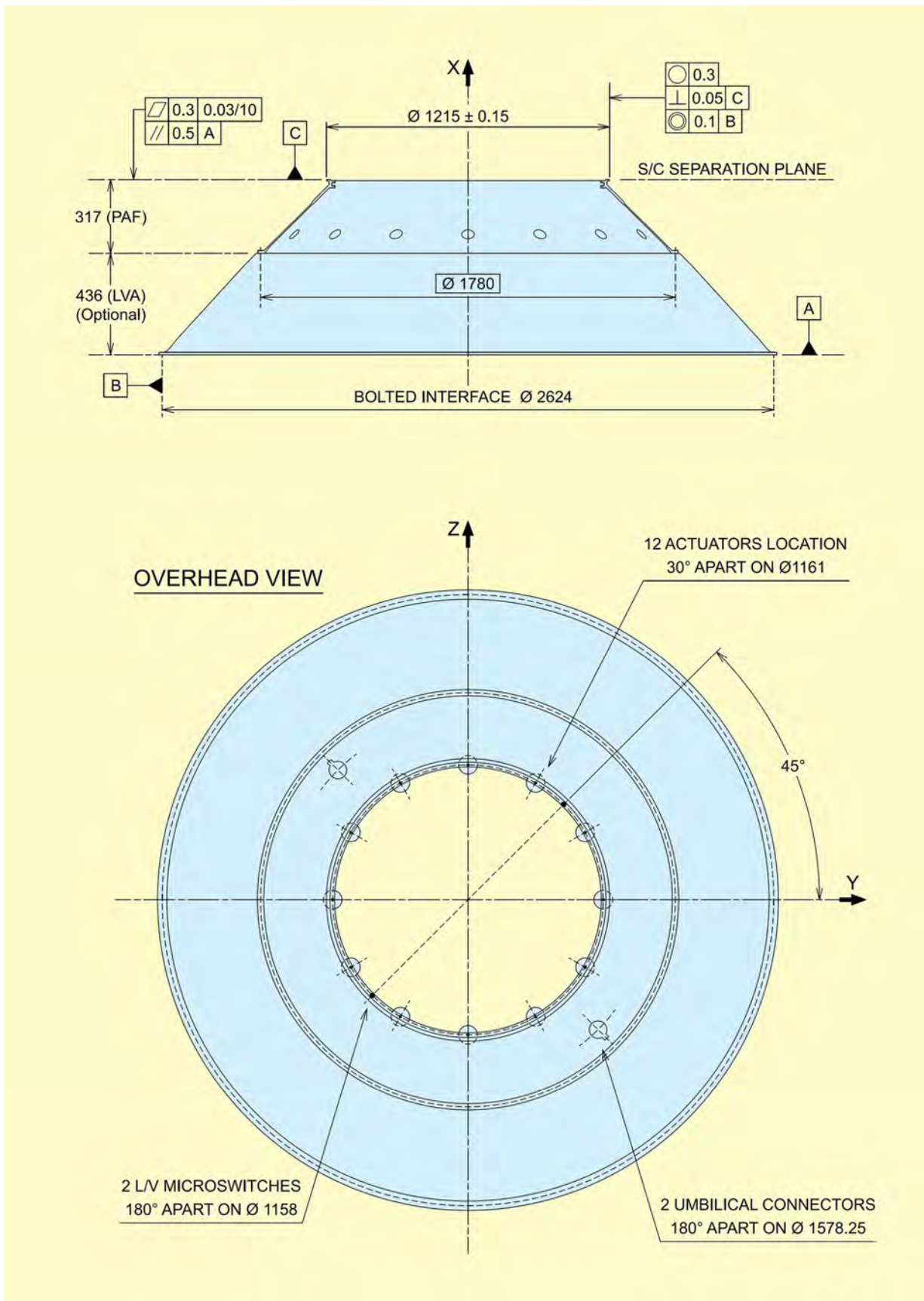

Figure A8.2 – PAS 1194VS – General View

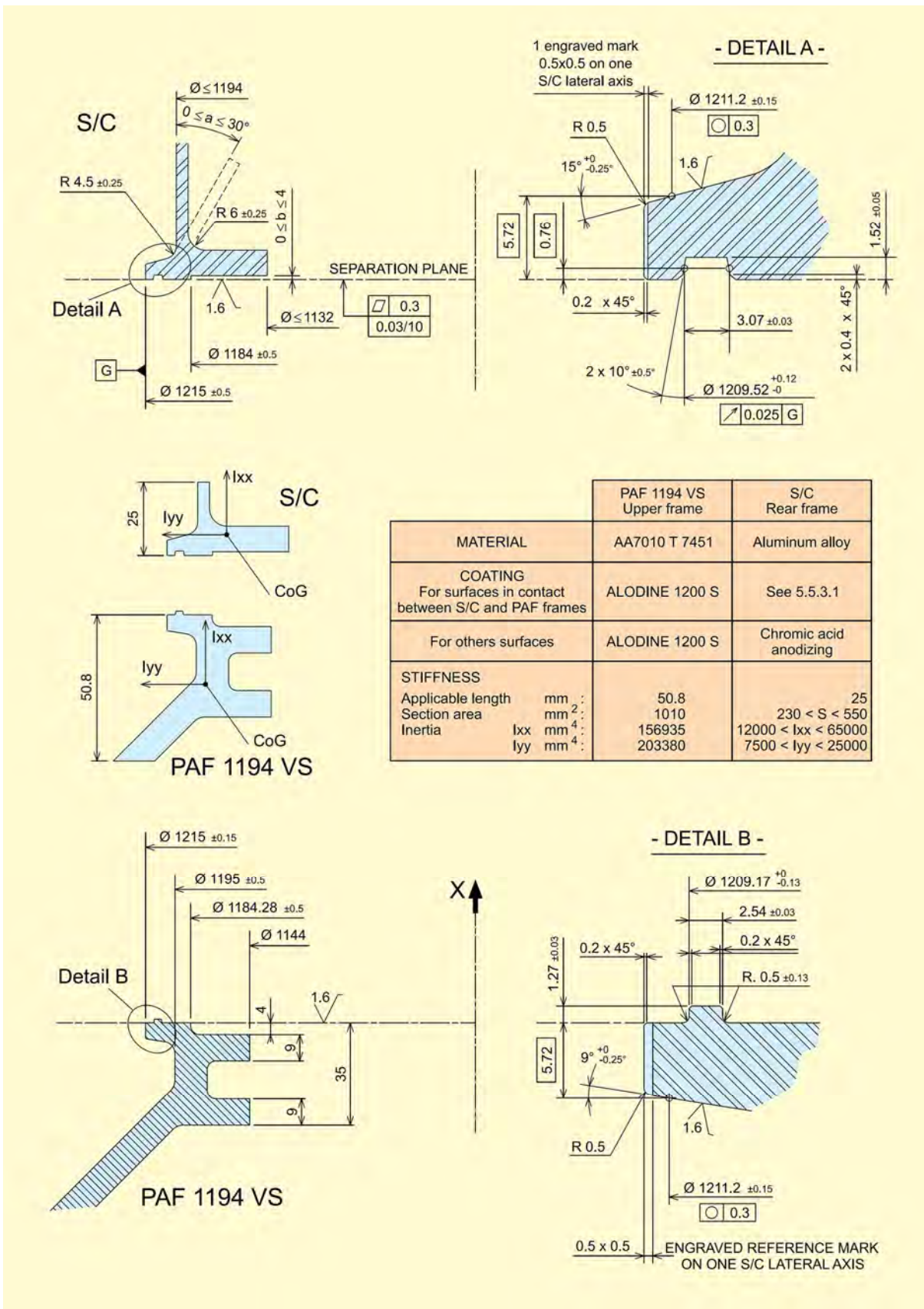

Figure A8.3 – PAS 1194VS – Interface Frames

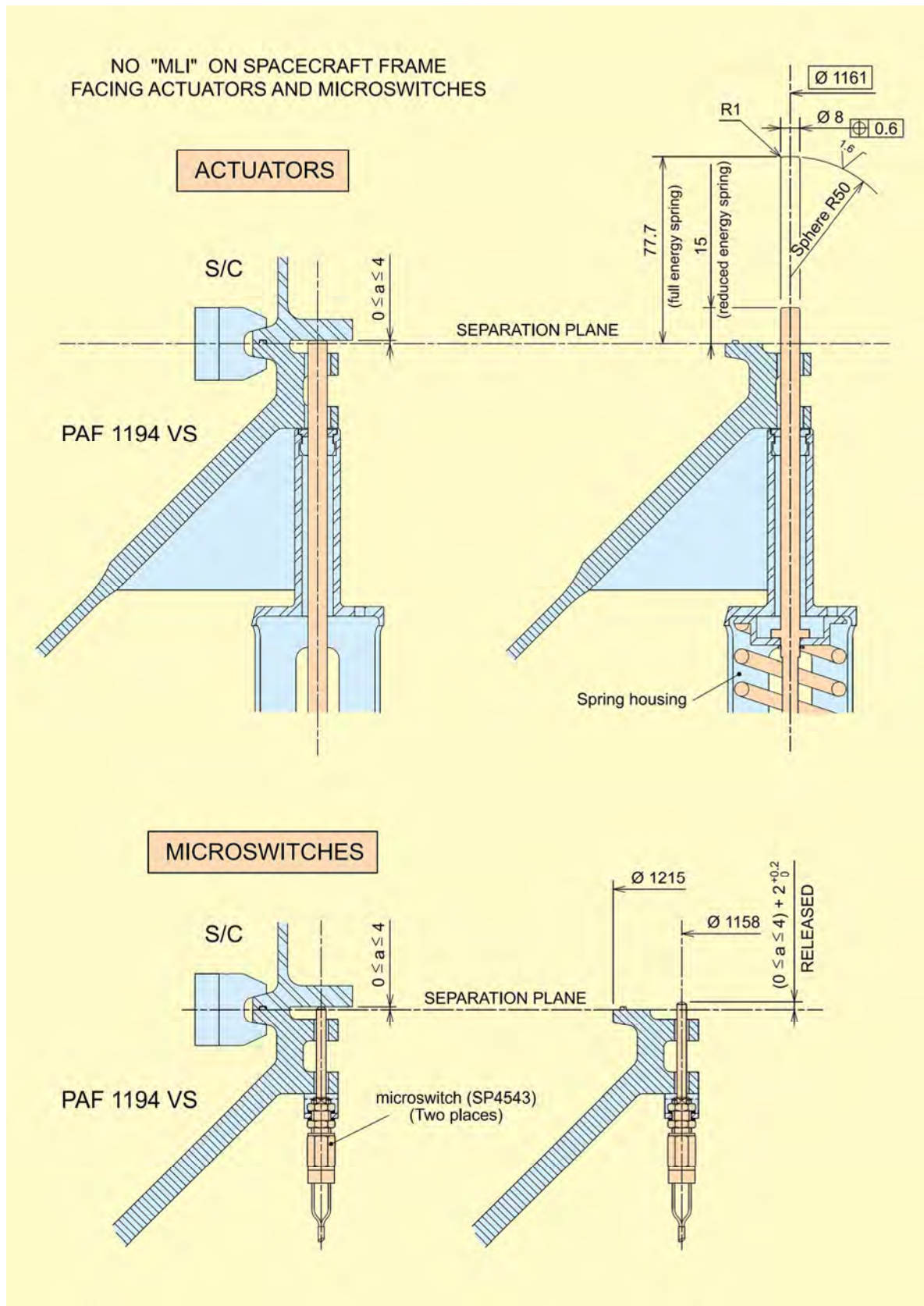

Figure A8.4 – PAS 1194VS – Actuators and microswitches

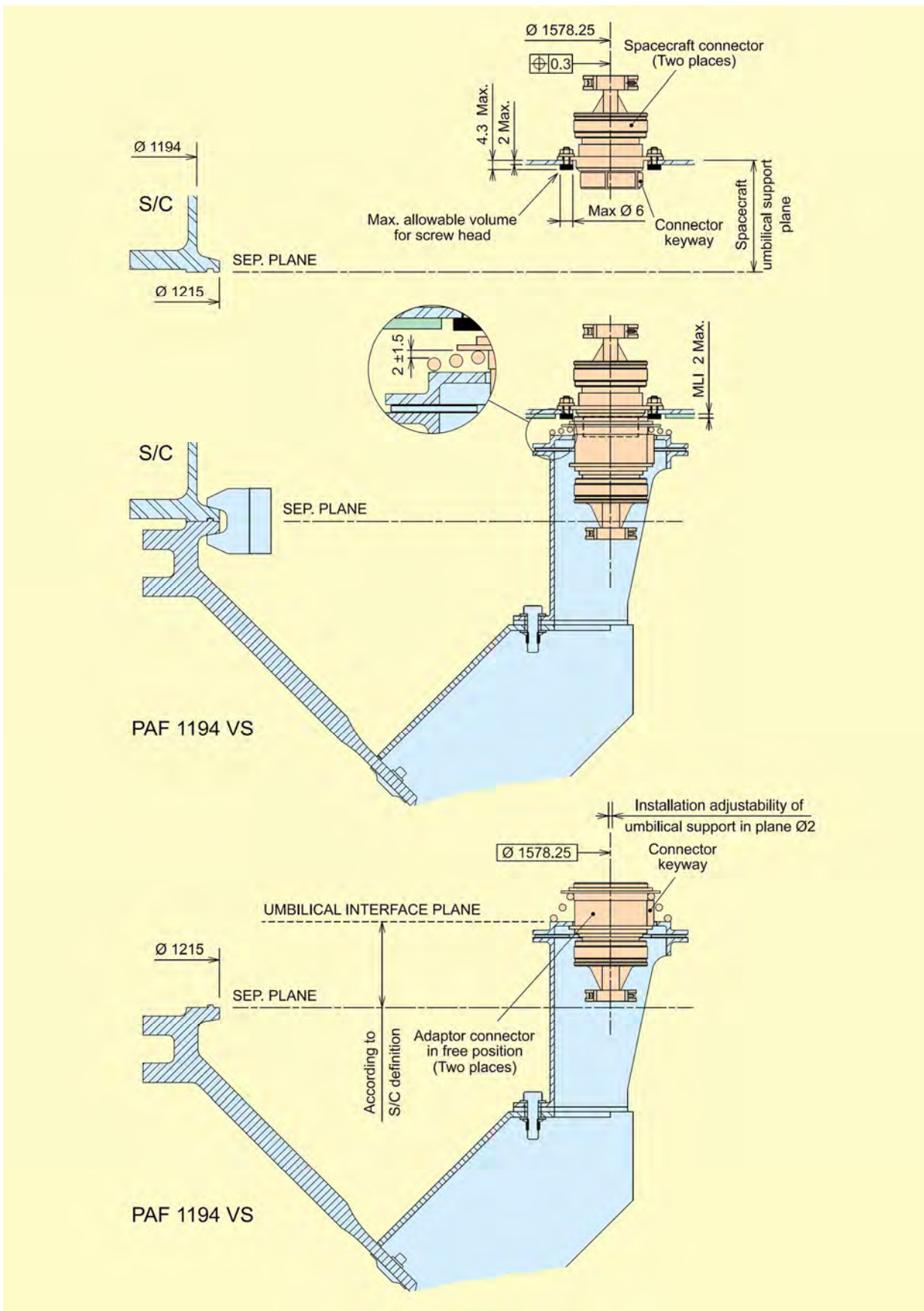

Figure A8.5 – PAS 1194VS – Umbilical connectors

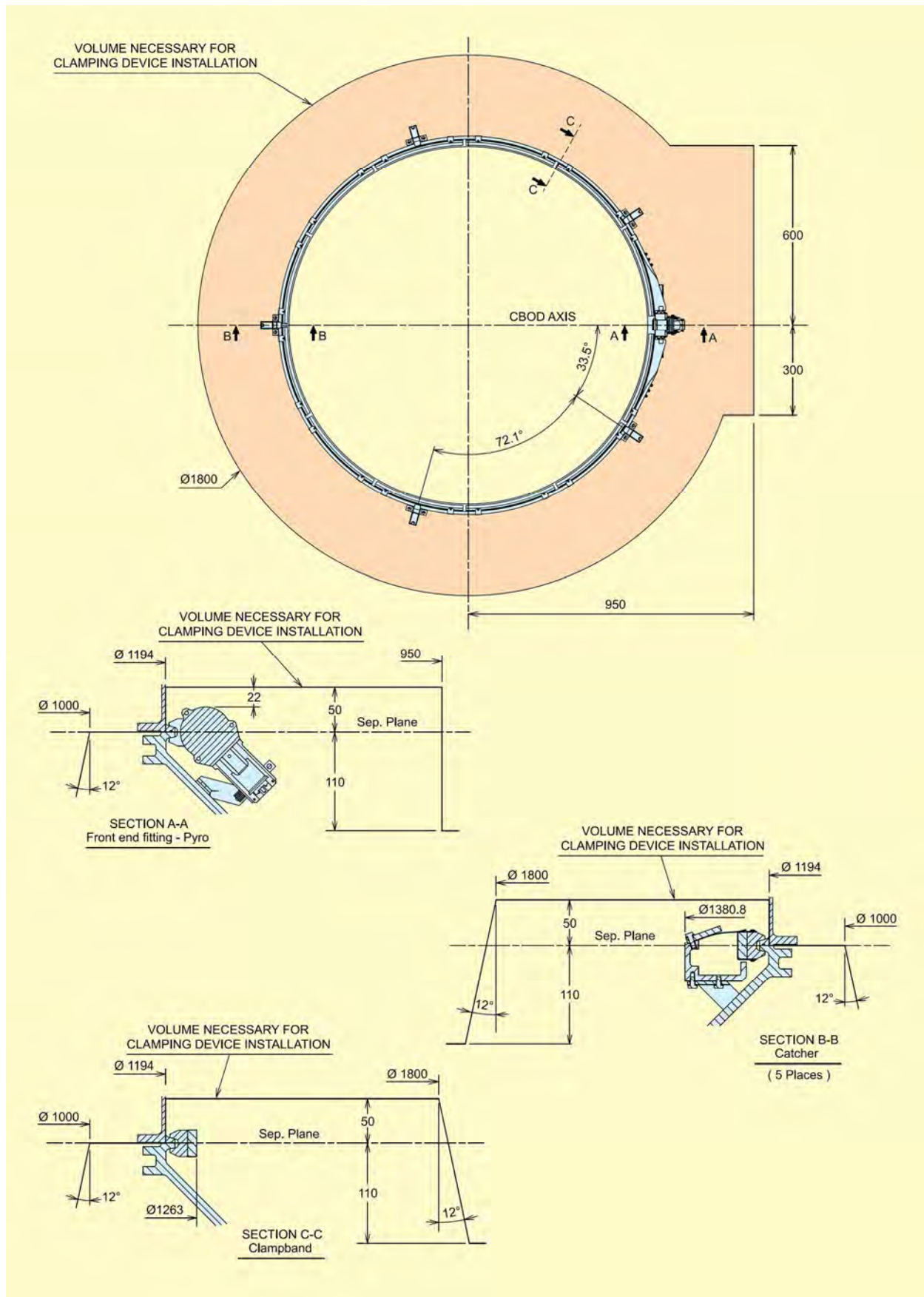

Figure A8.6 – PAS 1194VS – Clamping device interface

PAS 1194

PAS 1194C

The PAS 1194C is mainly composed of:

- a load carrying structure,
- a separation and ejection subsystem,
- and an electrical subsystem.

The PAS 1194C exists in 2 versions.

The PAS 1194 C baseline version is bolted to the reference plane Ø2624 (top of SYLDA or top of cone 3936) and comprises the following elements:

- A conical shell made of monolithic CFRP with an integrated lower ring at 2624 I/F, manufactured by co-bonding technology;
- An aluminium alloy upper interface frame, integrated on top of the cone, with a diameter of 1194 mm at the level of the spacecraft separation plane.



The PAS 1194C variant A is divided in two elements:

- The monolithic aluminium upper cone, integrated on top of the LVA 2624 cone or on top of the LVA 3936 cone (Ø 1780), with a diameter of 1215 mm at the level of the spacecraft separation plane
- The optional composite lower cone called LVA 2624 (Launch Vehicle Adapter) bolted to the reference plane Ø 2624 (top of SYLDA or top of cone 3936). This part is not used in case of lower position on top of LVA 3936.
- Optionally, an intermediate Raising Cylinder (ACY 1780) with 1780 mm I/F diameter, ensuring sufficient gap between spacecraft lower protrusions and the adapter structure.

The spacecraft is secured to the adaptor interface frame by a clamping device, the shock-less LPSS* (Launcher Payload Separation System) 1194.

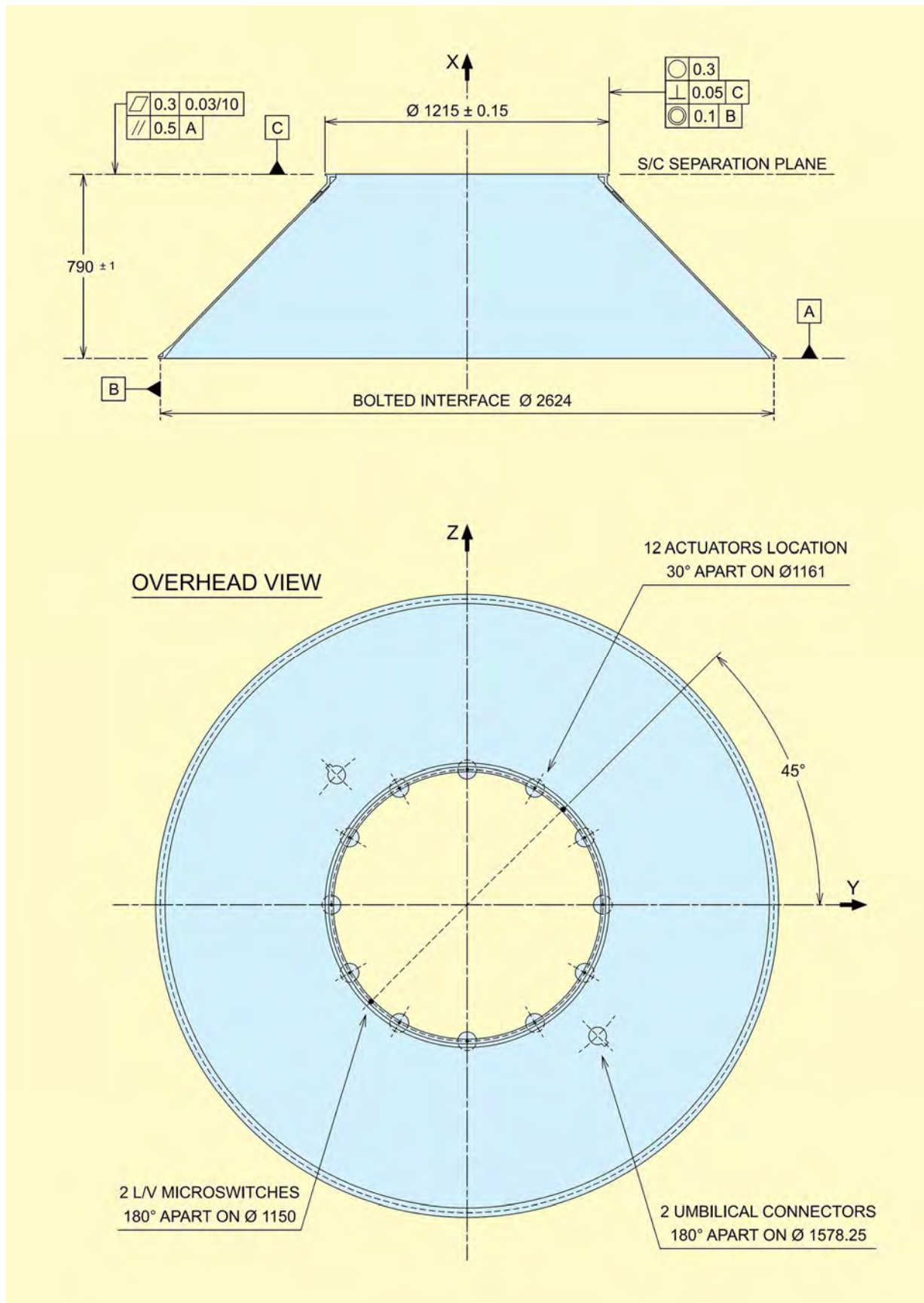

Figure A8.7 – PAS 1194C – General view

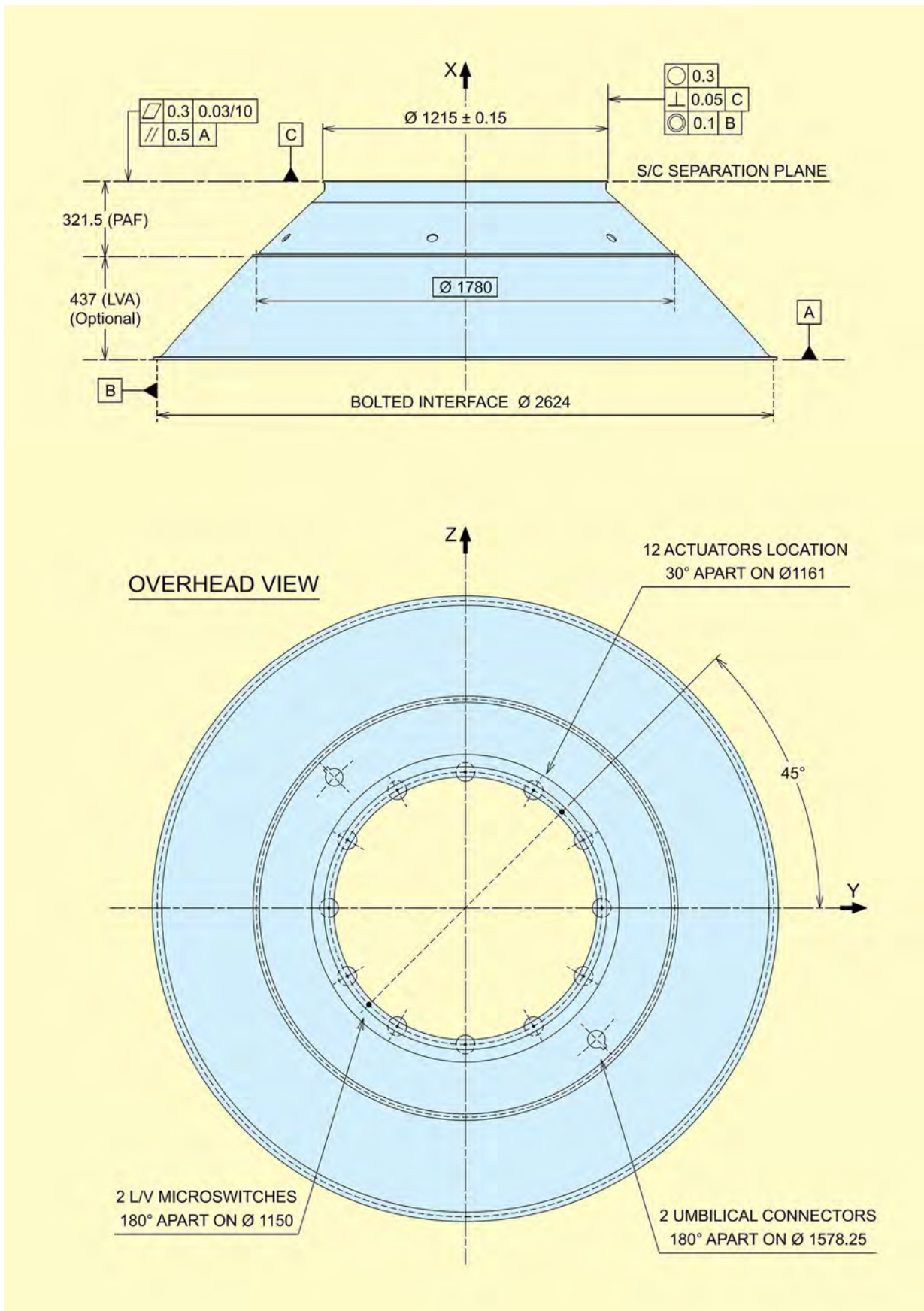

Figure A8.8 – PAS 1194C Variant A– General view

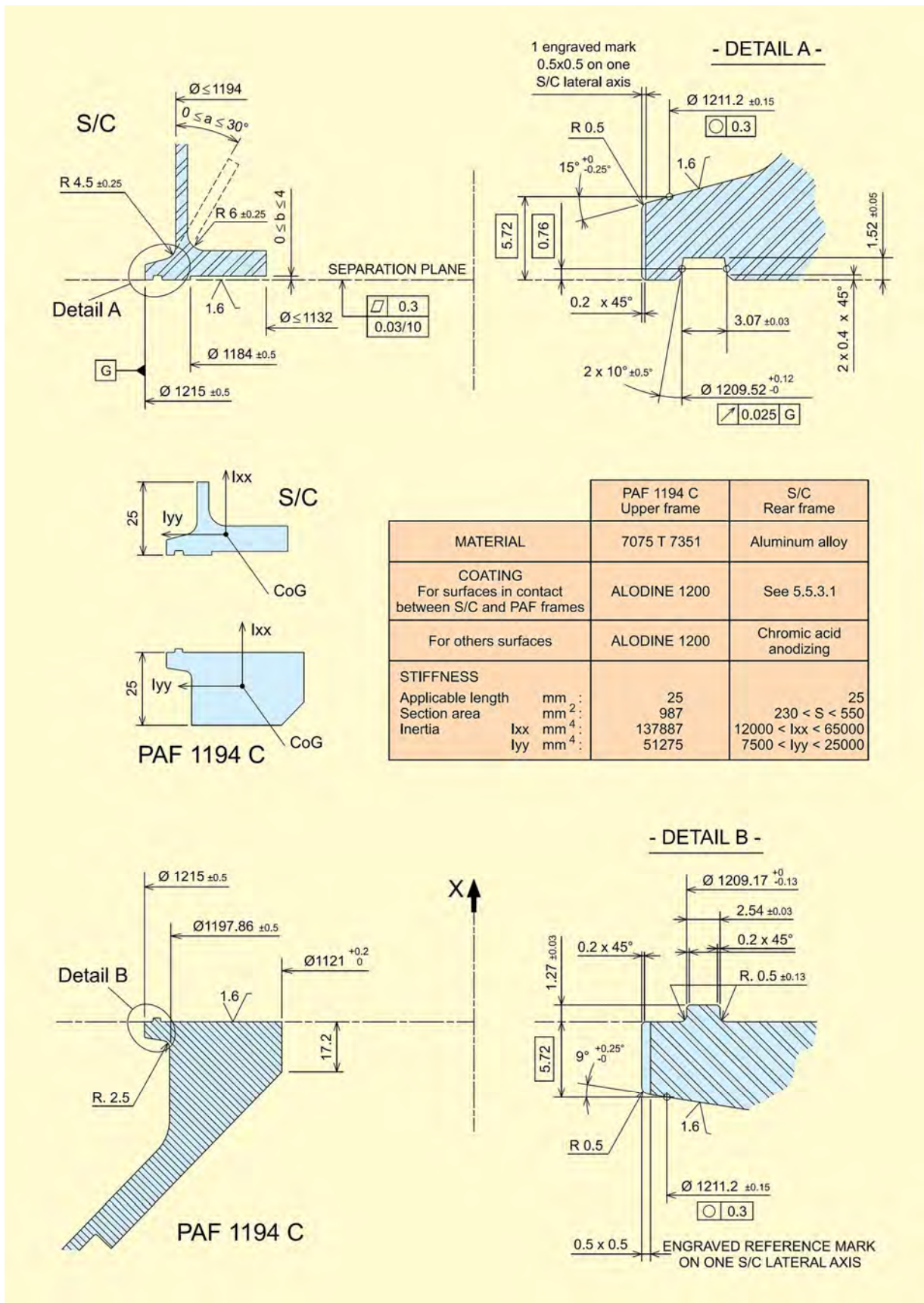

Figure A8.9 – PAS 1194C – Interface frames

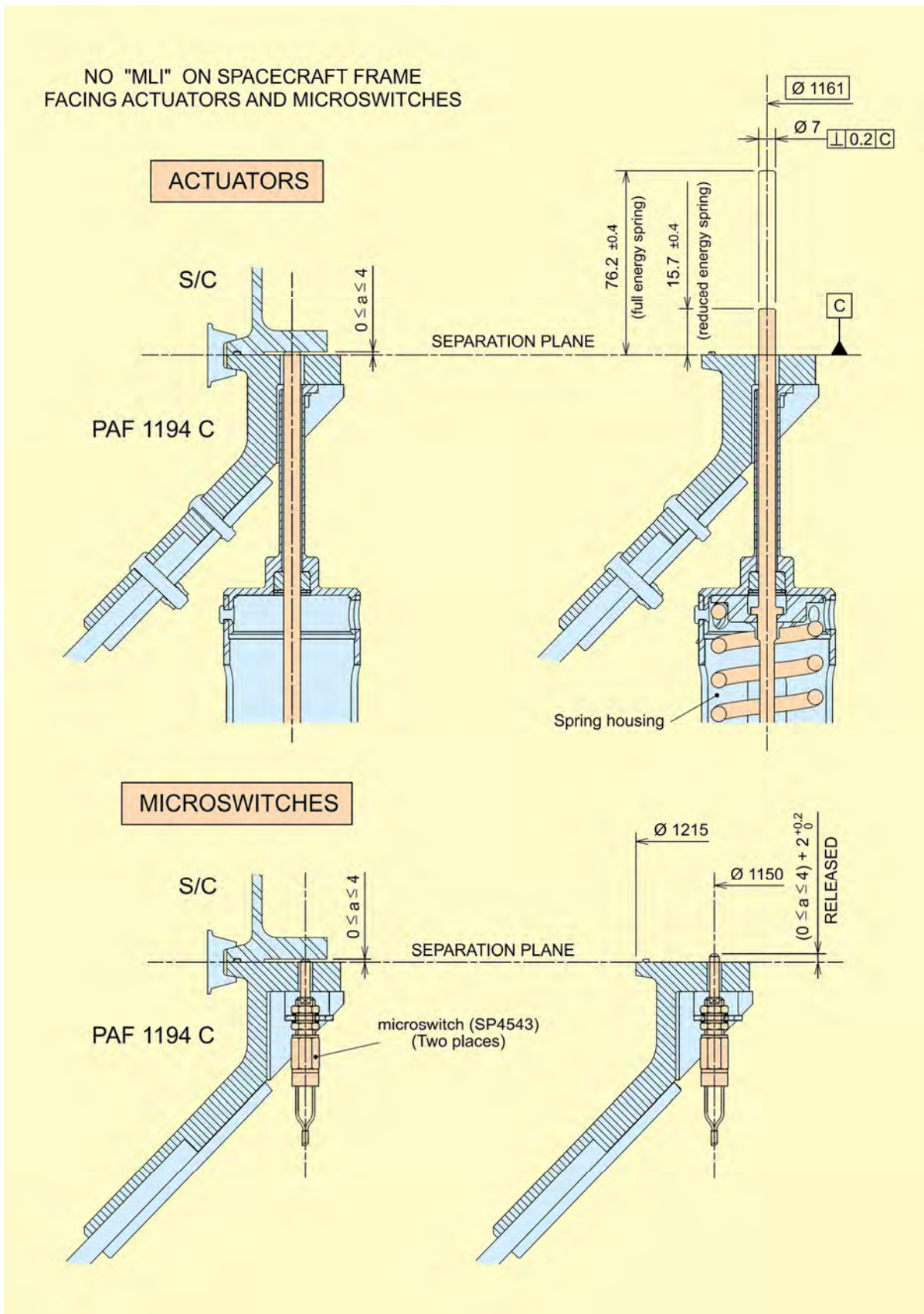

Figure A8.10 – PAS 1194C – Actuators and microswitches

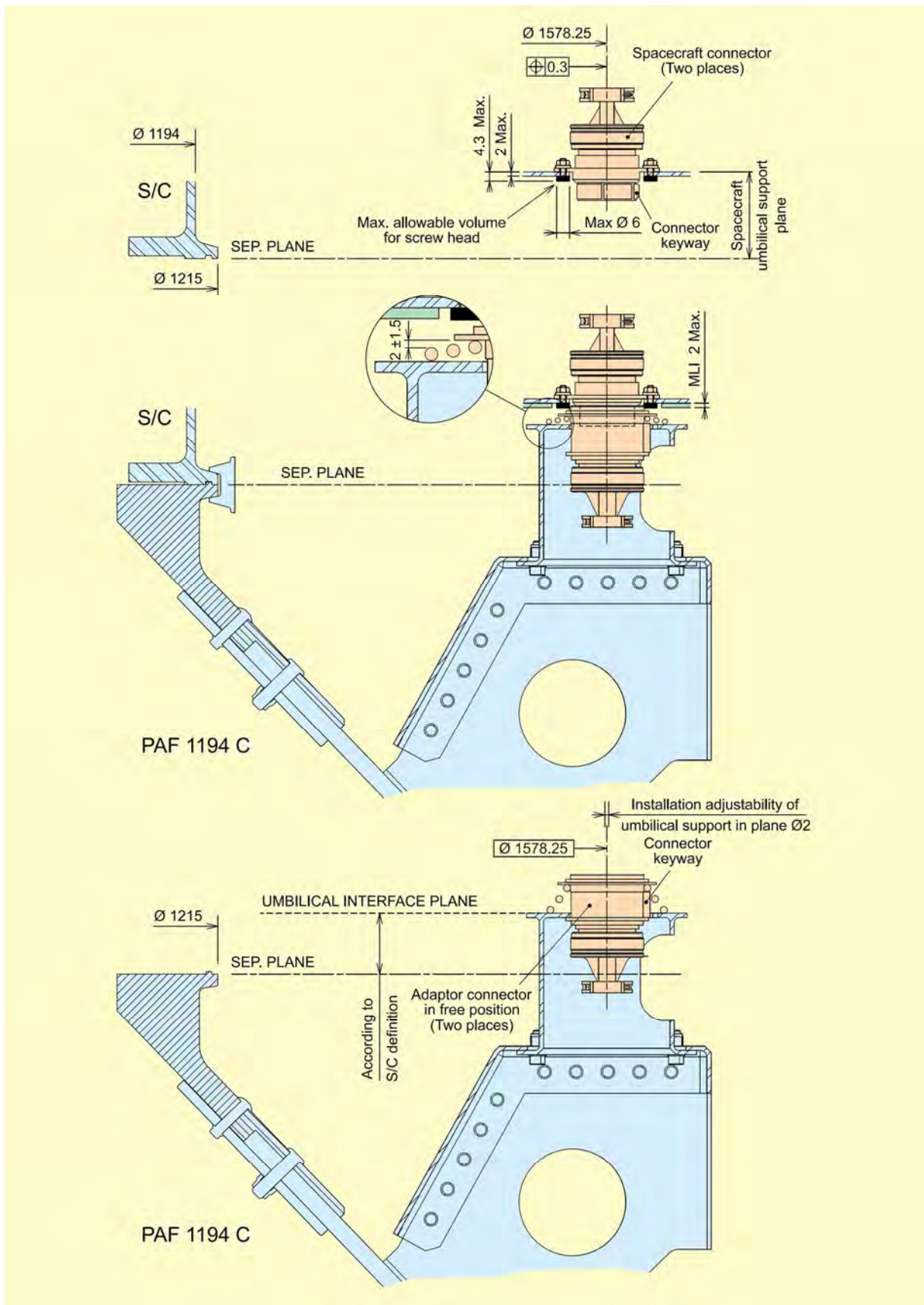

Figure A8.11 – PAS 1194C – Umbilical connectors

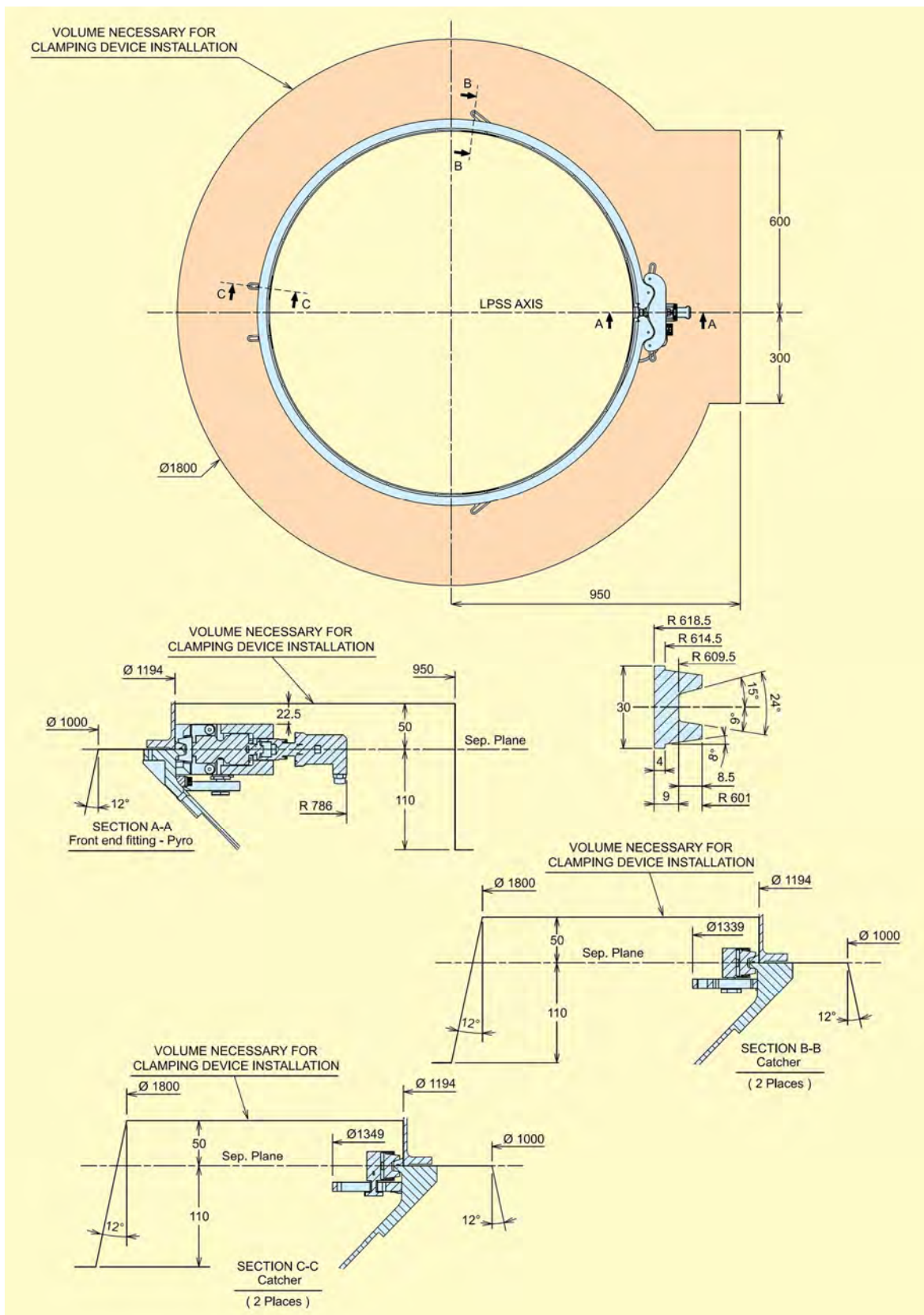

Figure A8.12 – PAS 1194C – Clamping device interface

- USABLE VOLUME FOR 1194 mm DIAMETER ADAPTERS -

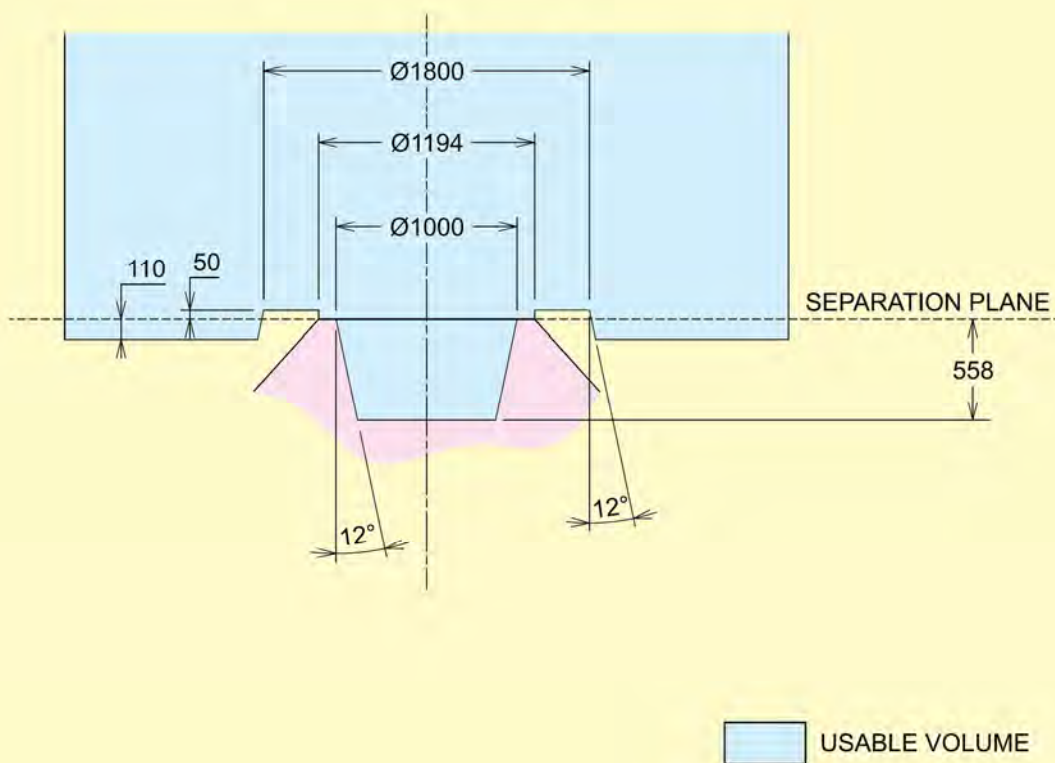

Figure A8.13 – Adapter 1194mm – Usable volume

Payload Adapter System 1663

Annex 9

The PAS 1663 is composed of the following subsystem:

- Payload Attachment Fitting (PAF 1663), including Separation Subsystem,
- Launch Vehicle Adapter (LVA) 2624,
- Electrical Subsystem.

As an option, the raising cylinder ACY 1780 can be included as a structural element situated between the PAF 1663 and the LVA 2624.

The PAF 1663 is a monolithic aluminium structure bolted on the LVA 2624 or directly on LVA 3936 if used in lower position.

The optional LVA 2624 is a honeycomb structure made in carbon fibre reinforced plastics with lower interface of 2624 mm diameter and upper interface of 1780mm diameter. This part is not used in case of lower position on top of LVA 3936.

The PAS 1663 has a maximum mass of 165 kg and it has been qualified to support a payload mass up to 7000 kg centred at 1700 mm from the separation plane.

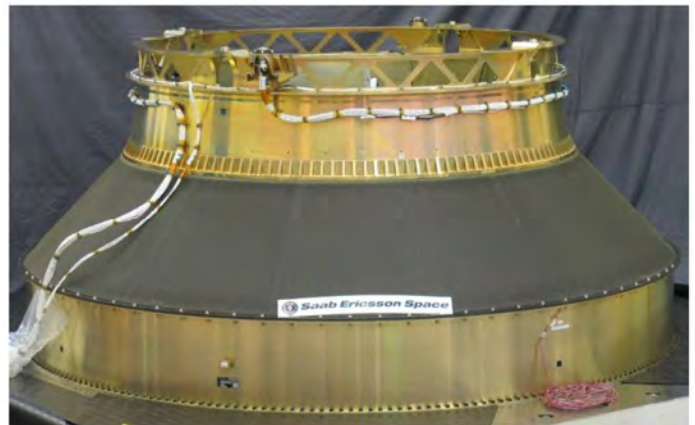

The separation and ejection subsystem consists of the following elements, positioned in sets at 4 positions around the top of the adapter:

- a bolt catcher assembly,
- a separation nut, including 2 pyrotechnic initiators with booster cartridges per nut,
- a separation bolt with a strain gauge,
- a spring mounted in a housing with a guided pushrod.

At separation, the 4 separation nuts are operated by gas pressure generated by booster cartridges. The threaded segments move away from the bolts, whose stored energy causes them to eject from the nuts.

The spacecraft is pushed away from the launch vehicle by 4 springs sets positioned inside the PAF.

The force exerted on the spacecraft by each spring does not exceed 2350 N.

For the definition of the loads introduction and further information regarding the mechanical and the electrical interface please contact Arianespace.

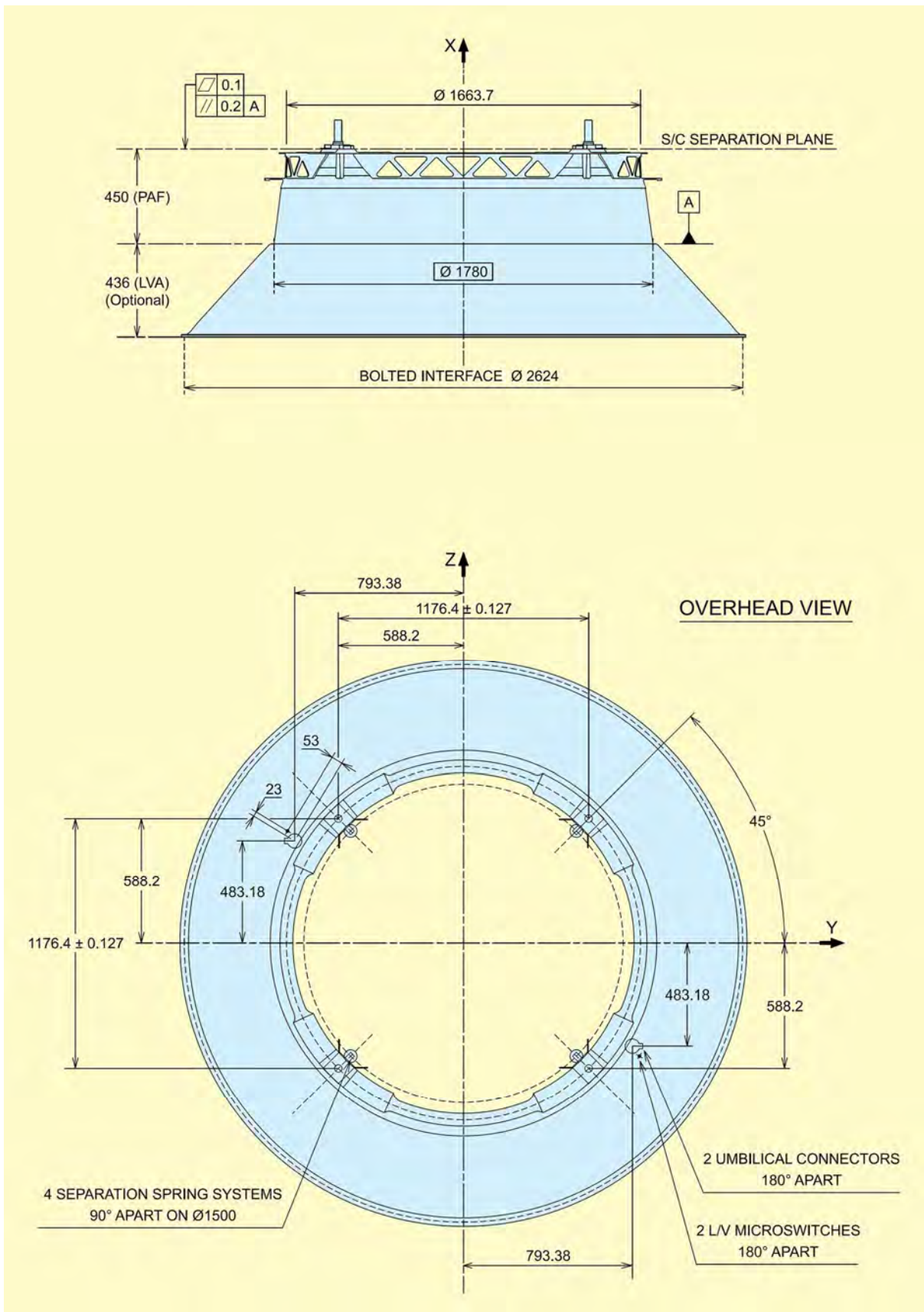

Figure A9.1 – PAS 1663 – General view

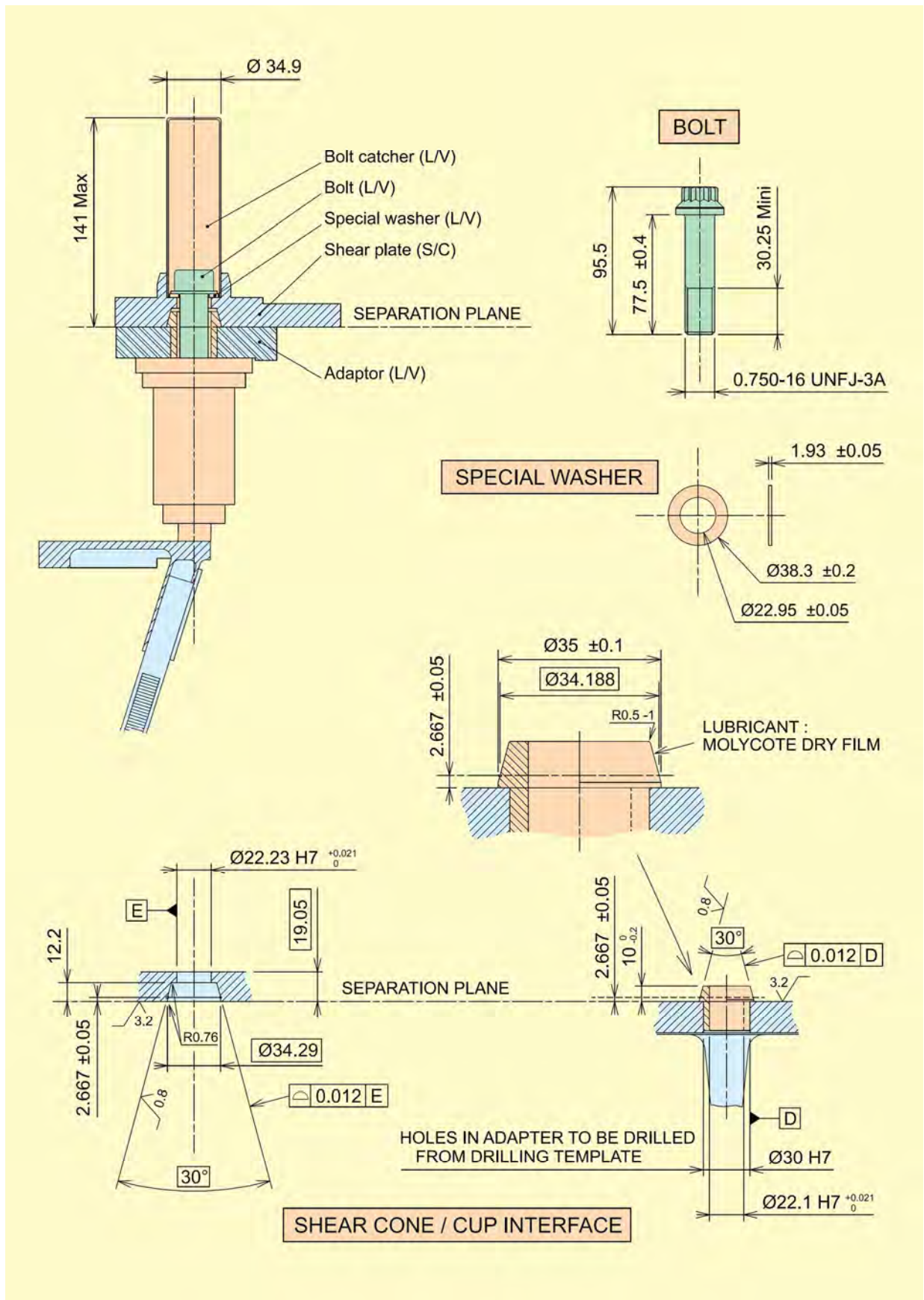

Figure A9.2 – PAS 1663 – Separation Subsystem

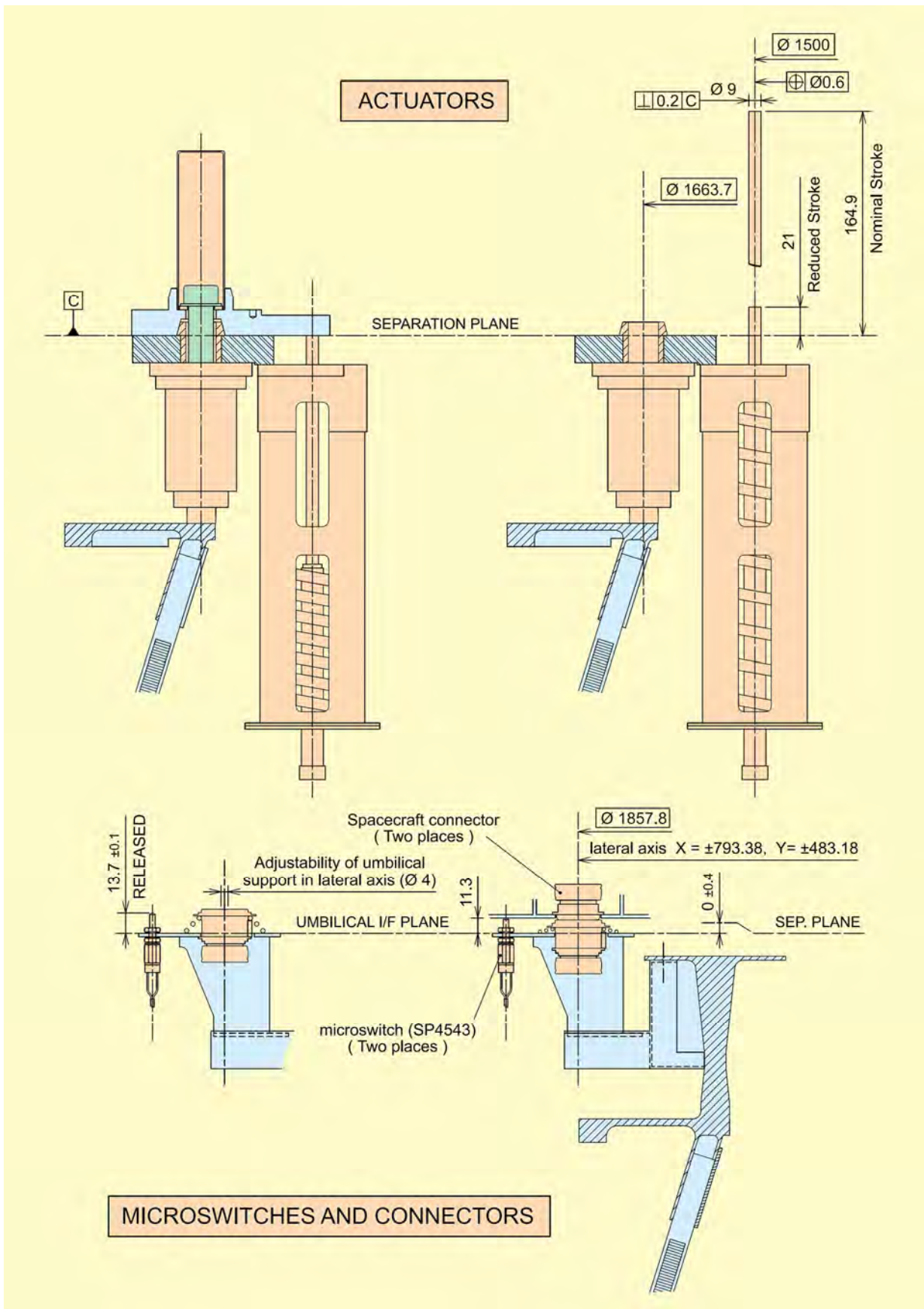

Figure A9.3 – PAS 1663 Umbilical connectors, actuators and microswitches

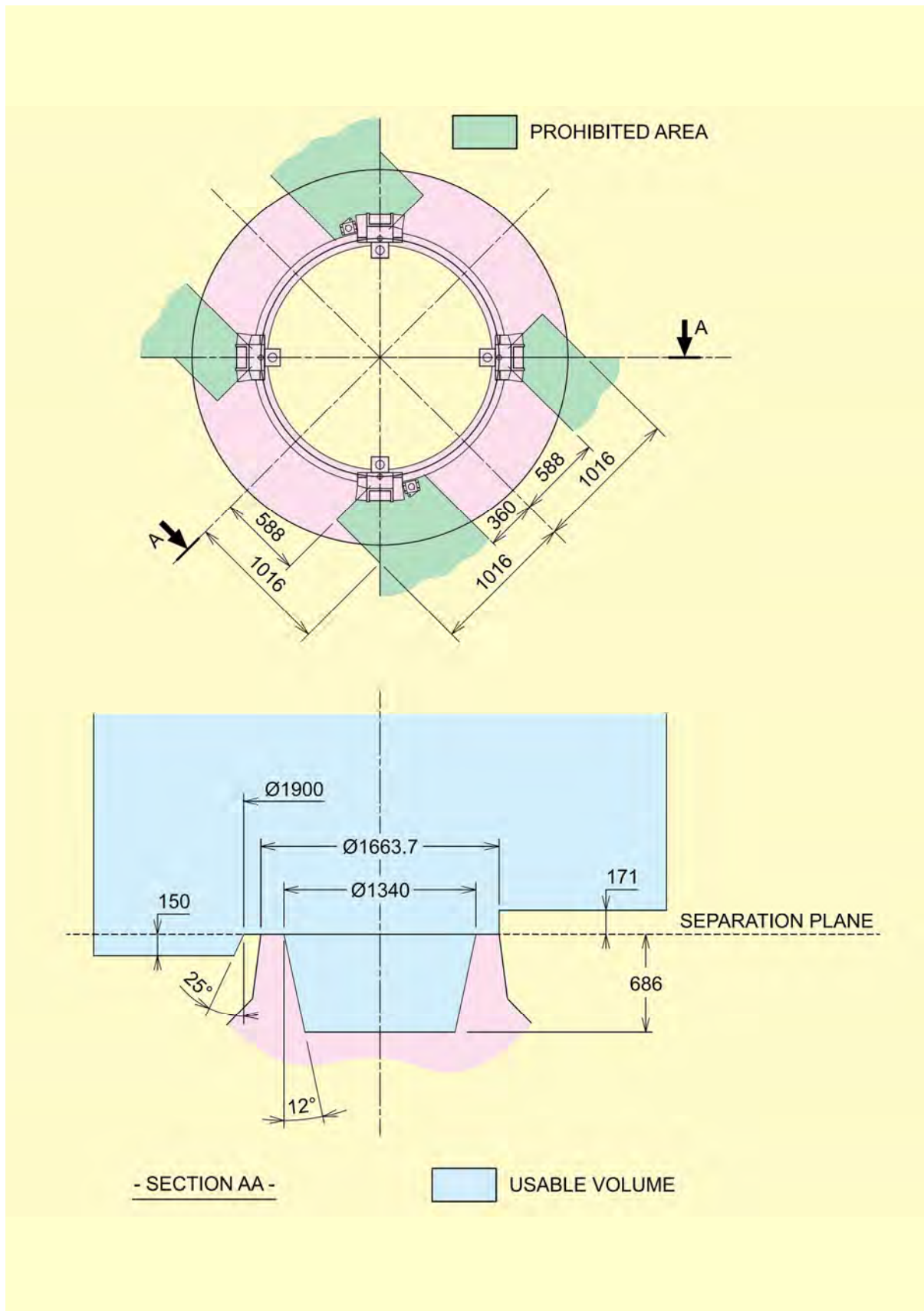

Figure A9.4 – PAS 1663 – Usable volume

Payload Adapter System 1666MVS

Annex 10

The PAS 1666MVS is mainly composed of:

- a structure,
- a clamping device,
- a set of 4 to 12 actuators.

The PAS 1666MVS structure comprises the following main parts:

- the monolithic aluminium upper cone called PAF (Payload Attachment Fitting) 1666MVS, integrated on top of the LVA 2624 or on top of LVA 3936 ($\varnothing 1780$), with a diameter of 1666 mm at the level of the spacecraft separation plane;
- the optional composite lower cone called LVA 2624 (Launch Vehicle Adapter) bolted to the reference plane $\varnothing 2624$ (top of SYLDA or top of cone 3936). This part is not used in case of lower position on top of LVA 3936.
- optionally, an intermediate metallic ring for specific accommodations needs (ACY 1780), included as a structural element, situated between the PAF 1666MVS and the LVA 2624.

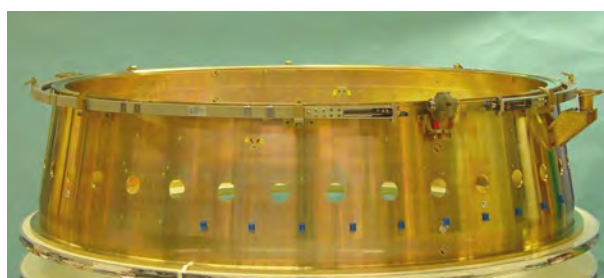
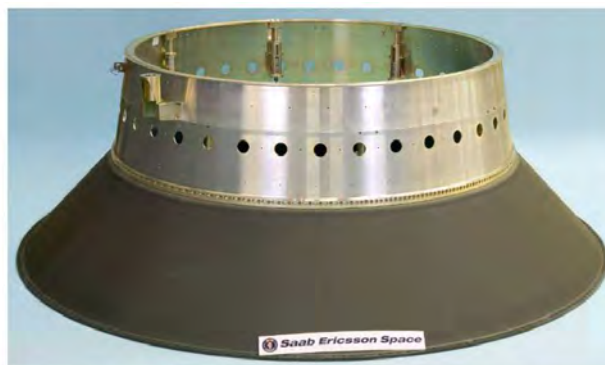

The PAS 1666MVS has been designed and qualified to support a payload of 6000 kg centred at 2000 mm from the separation plane.

The PAS 1666MVS has a maximum mass of 160 kg.

The spacecraft is secured to the adapter interface frame by a clamping device. The clamp band consists of a band with one connecting point. The tension applied to the band provides pressure on the clamp which attaches the satellite to the launcher. Release is obtained by means of a Clamp Band Opening Device (CBOD) pyrotechnically initiated. The CBOD is specially designed to generate low shock levels. Finally a set of catchers secures a safe behaviour and parks the clamp band on the adapter.

The clamping tension may go up to 72 kN at any time, for the nominal bolt pretension load of 60 kN.

The spacecraft is forced away from the launch vehicle by the separation springs (4 to 12), positioned inside the PAF and located on the diameter $\varnothing 1600$ mm.

The force exerted on the spacecraft by each spring does not exceed 1500 N.

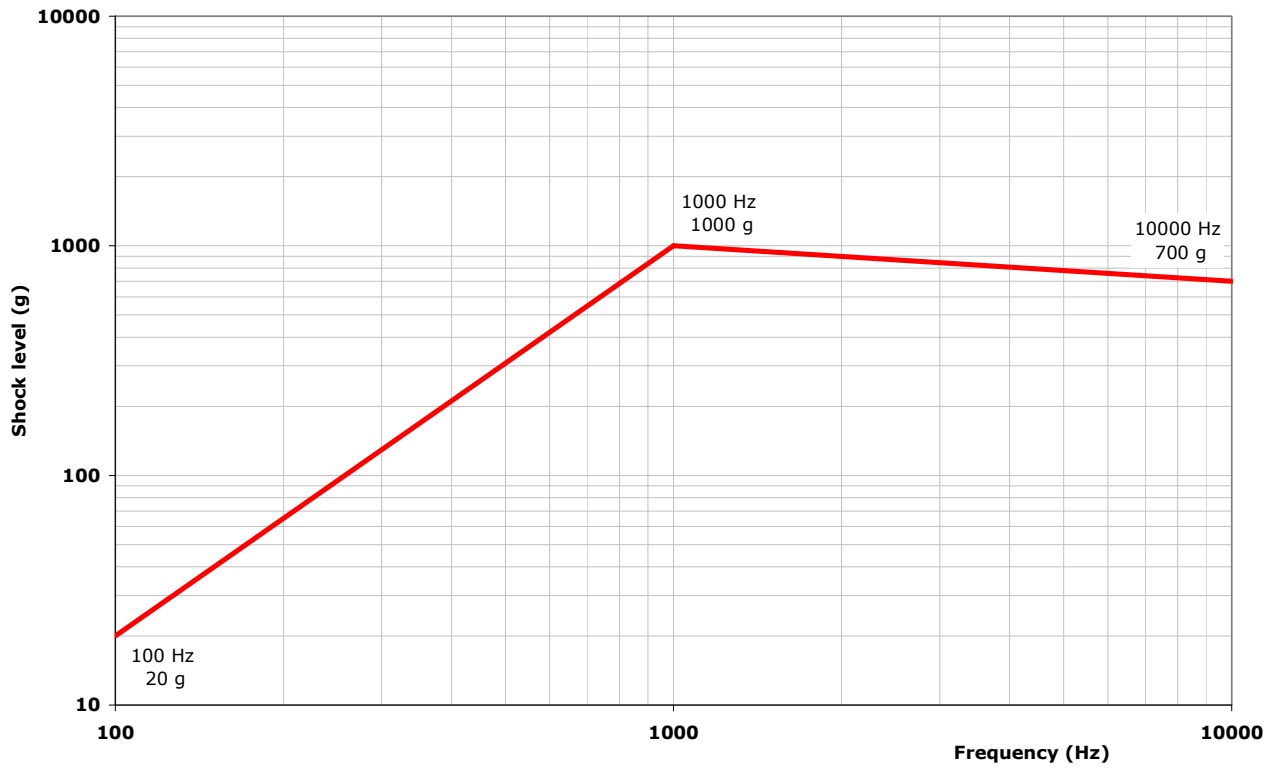

Figure A10.1 – PAS 1666MVS – Shock spectrum of clamp band release

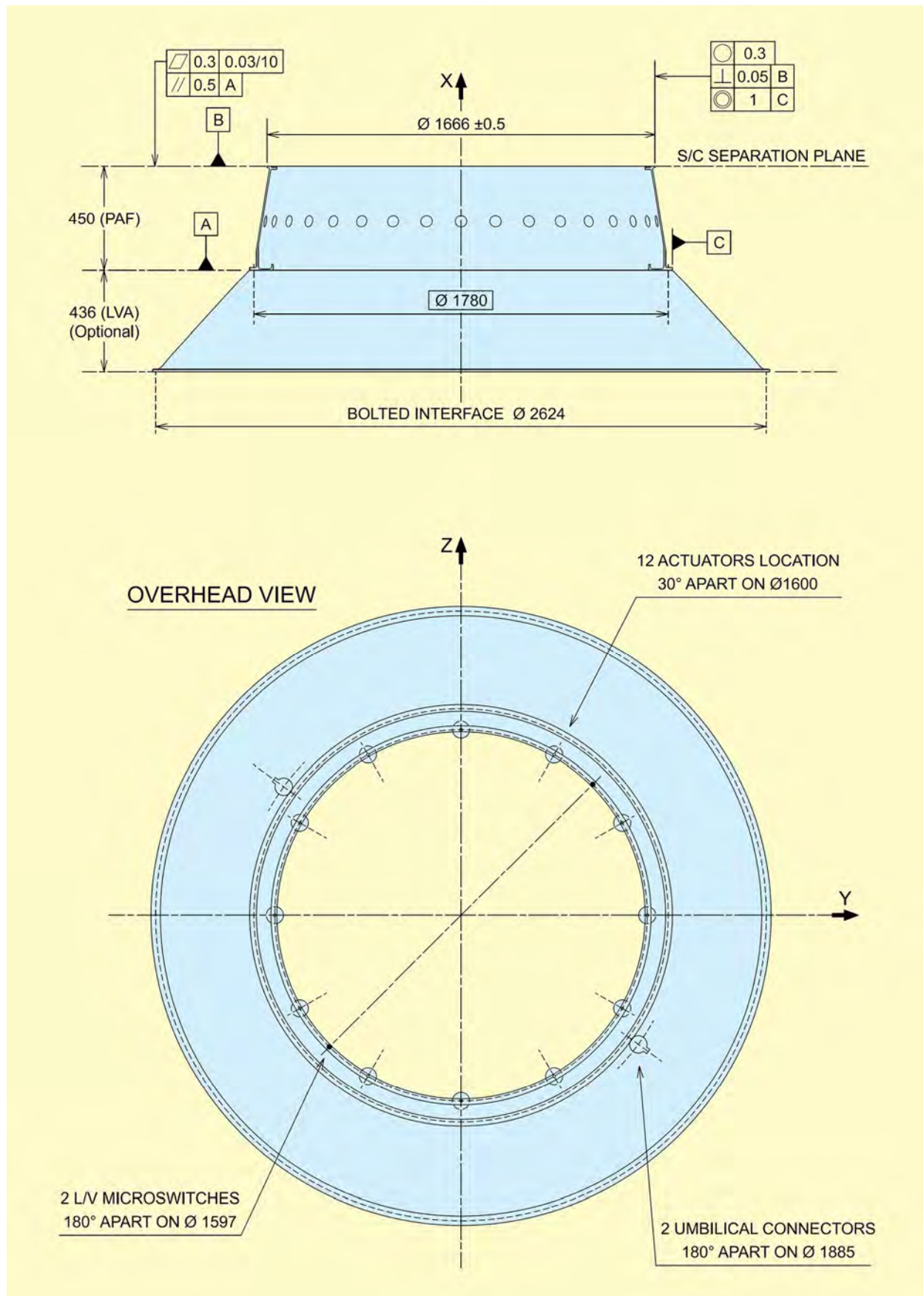

Figure A10.2 – PAS 1666MVS – General view

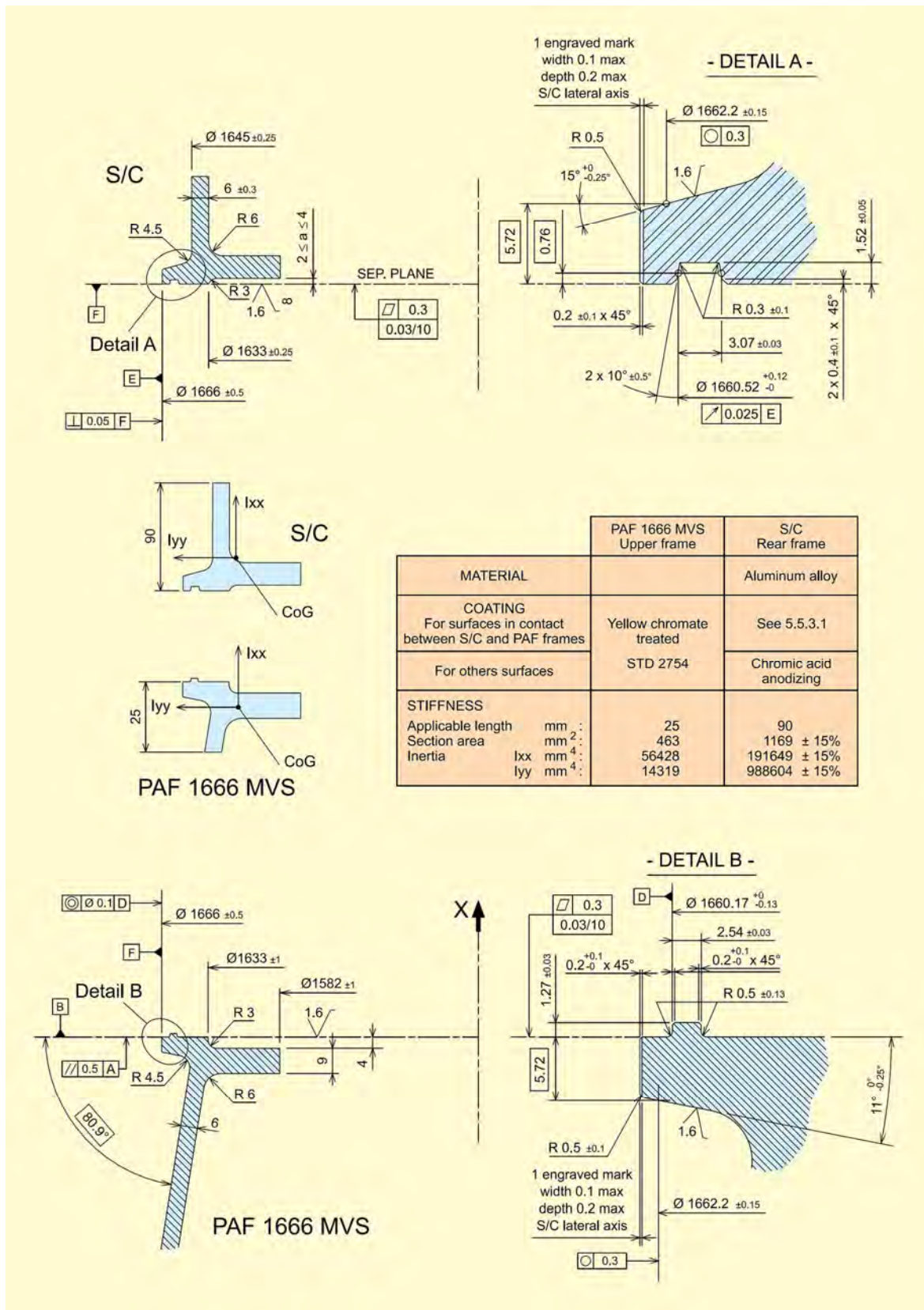

Figure A10.3 – PAS 1666MVS – Interface frames

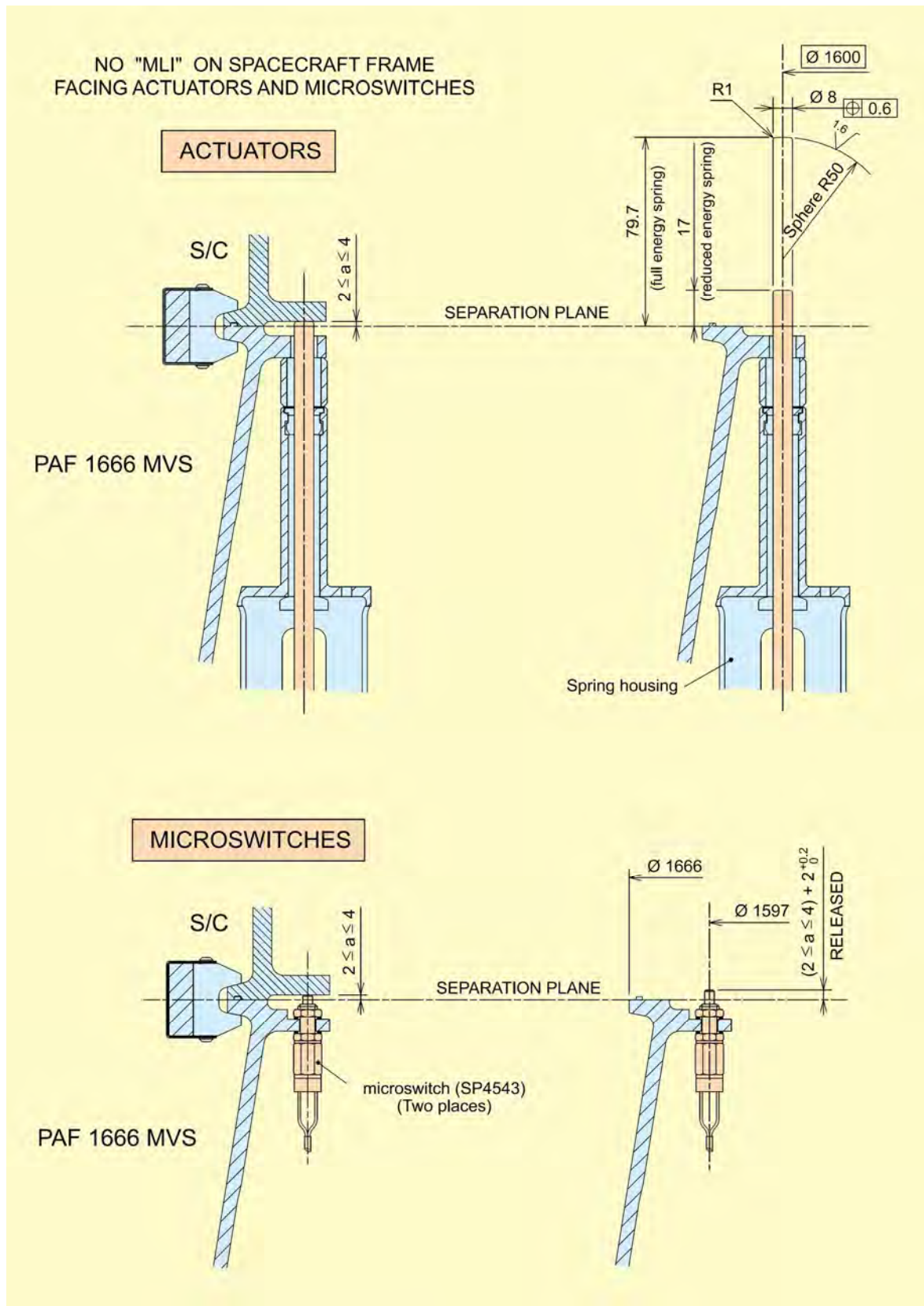

Figure A10.4 – PAS 1666MVS – Actuators and microswitches

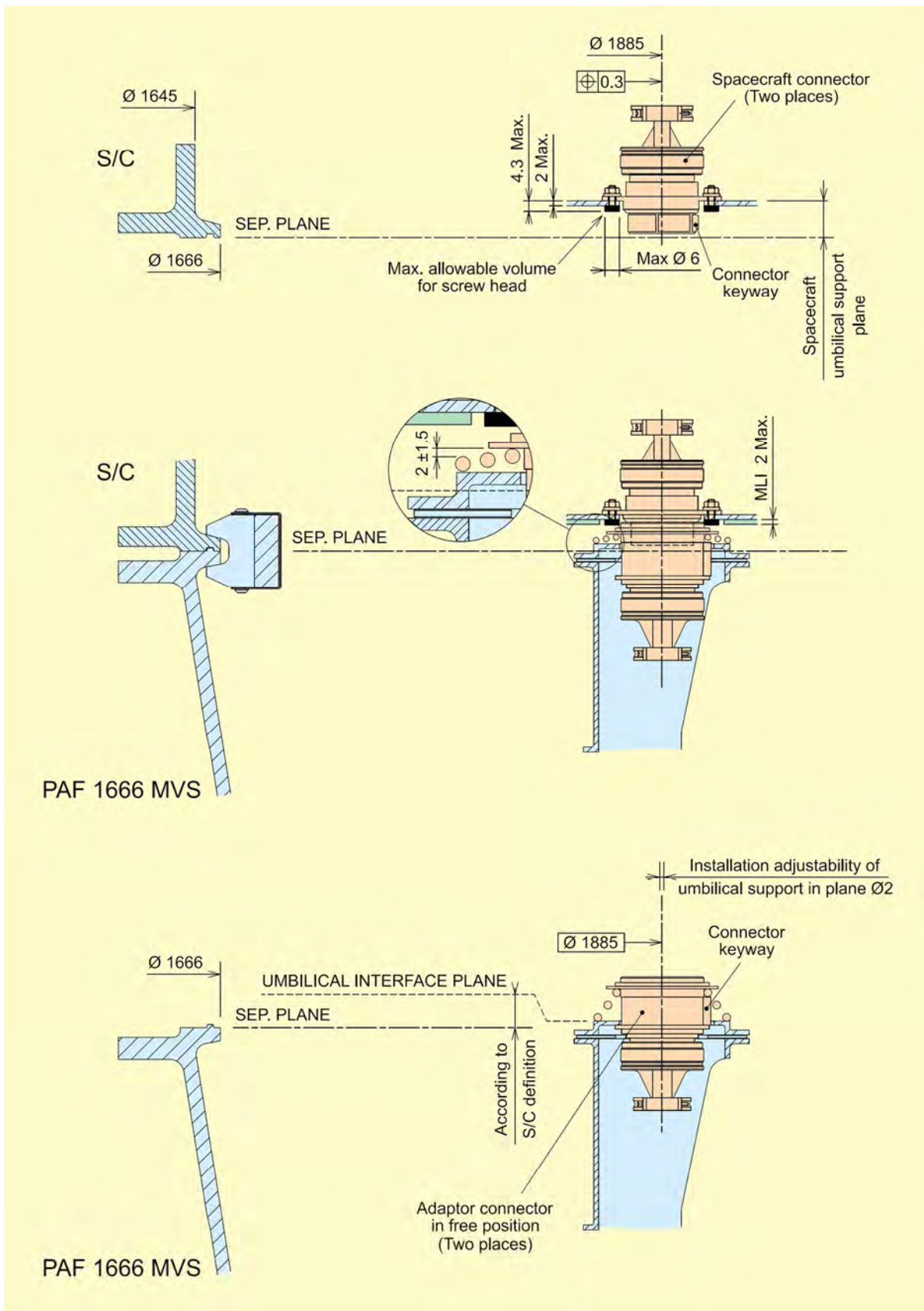

Figure A10.5 – PAS 1666MVS – Umbilical connectors

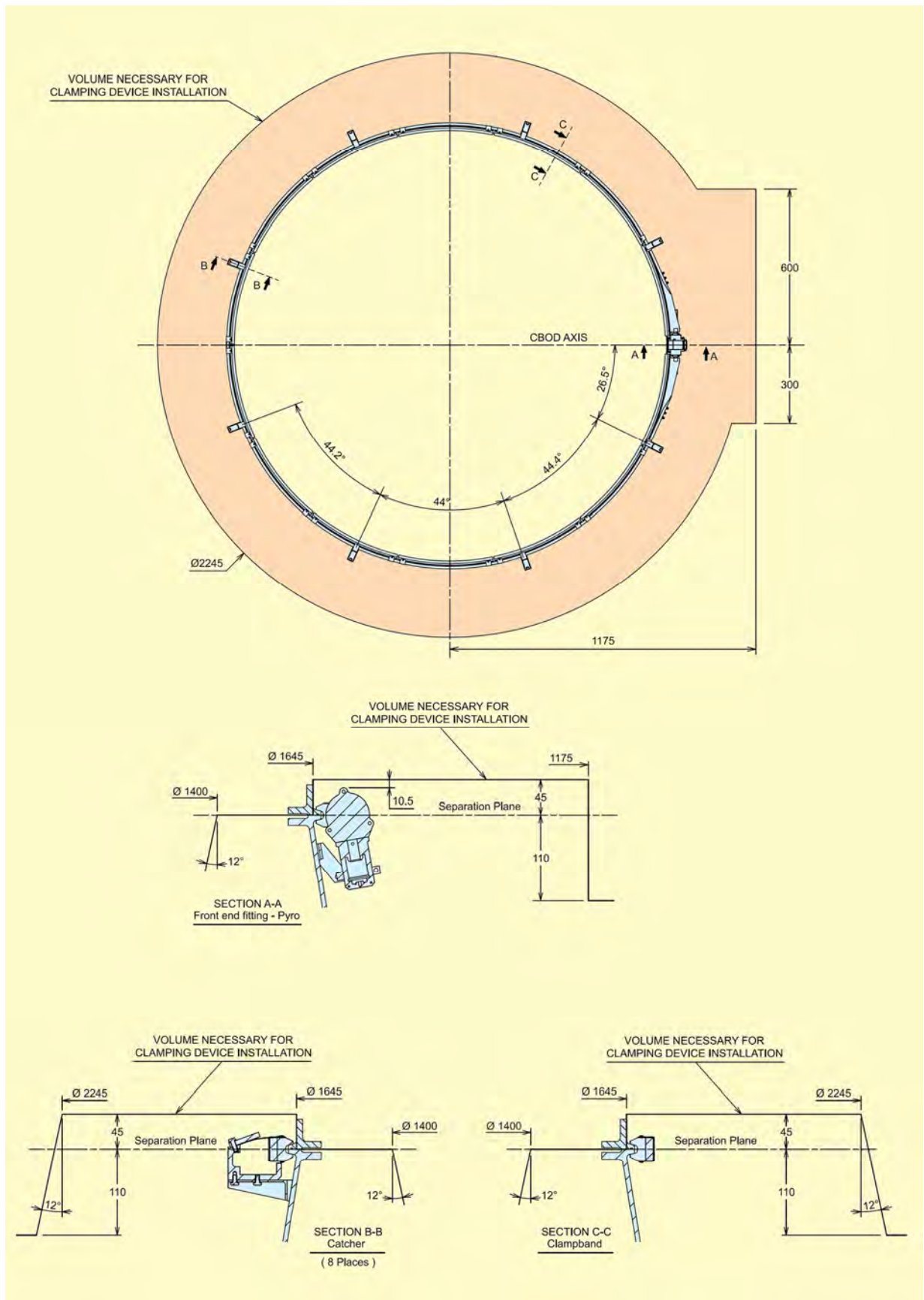

Figure A10.6 – PAS 1666MVS – Clamping Device Interface

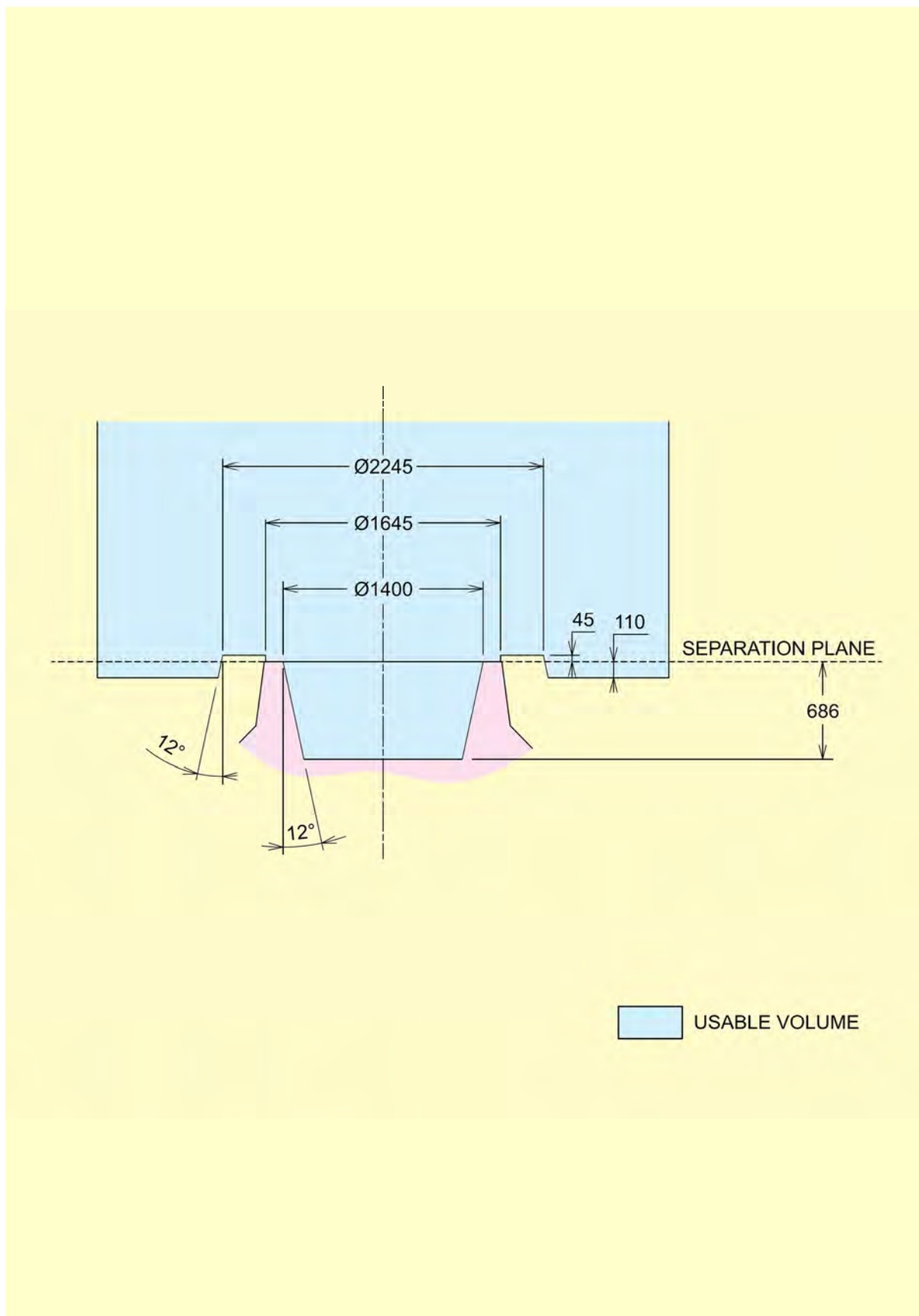

Figure A10.7 – PAS 1666MVS – Usable volume

Payload Adapter System 1666S

Annex 11

The Payload Adapter System 1666S has been developed for its use on the Alphaspace platform. The total mass of the PAS 1666S is 195 kg.

The PAS 1666S is composed of the following subsystems:

- Payload Attachment Fitting PAF 1666S,
- Launch Vehicle Adapter LVA 2624 (optional),
- Electrical Subsystem,
- Separation Subsystem.

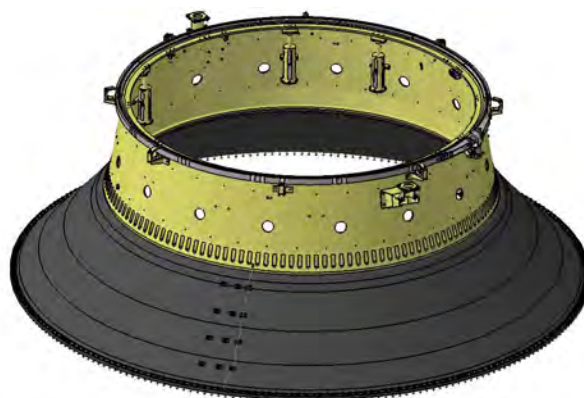

The PAS 1666S structure consists of two main parts:

- the monolithic aluminium PAF (Payload Attachment Fitting) 1666S, with a height of 450 mm, with a diameter of 1666 mm at the level of the spacecraft separation plane; integrated on top of the LVA 2624 or on top of LVA 3936.
- the optional composite lower cone called LVA 2624 (Launch Vehicle Adapter) a monolithic CFRP shell structure, with a height of 432 mm, bolted to the reference plane $\varnothing 2624$ (top of SYLDA or top of cone 3936). This part is not used in case of lower position on top of LVA 3936.

The PAS 1666S has been designed to support a payload of 9000 kg centred at 2500 mm from the separation plane.

The Separation Subsystem consists of a Clamp Band with a soft opening device (CBOD), and the Separation Spring Set. The Separation Subsystem will, upon an electrical command from the LV, release and separate the spacecraft from the Launch Vehicle.

The clamping tension does not exceed 72kN at any time, for the nominal bolt pretension load of 60kN.

The Electrical Subsystem contains the wiring for umbilical connection, power wiring for pyro activation and signal wiring for transmission of measurement data. It also contains the separation switches, measurements sensors, the electrical umbilical/ separation connectors and pyro connectors.

The adapter has an optional mechanical attachment bracket for mounting of a Nitrogen purging connector.

The spacecraft is forced away from the launch vehicle by the separation springs (number of springs adjustable between 4 and 12).

The force exerted on the spacecraft by each spring does not exceed 1500 N.

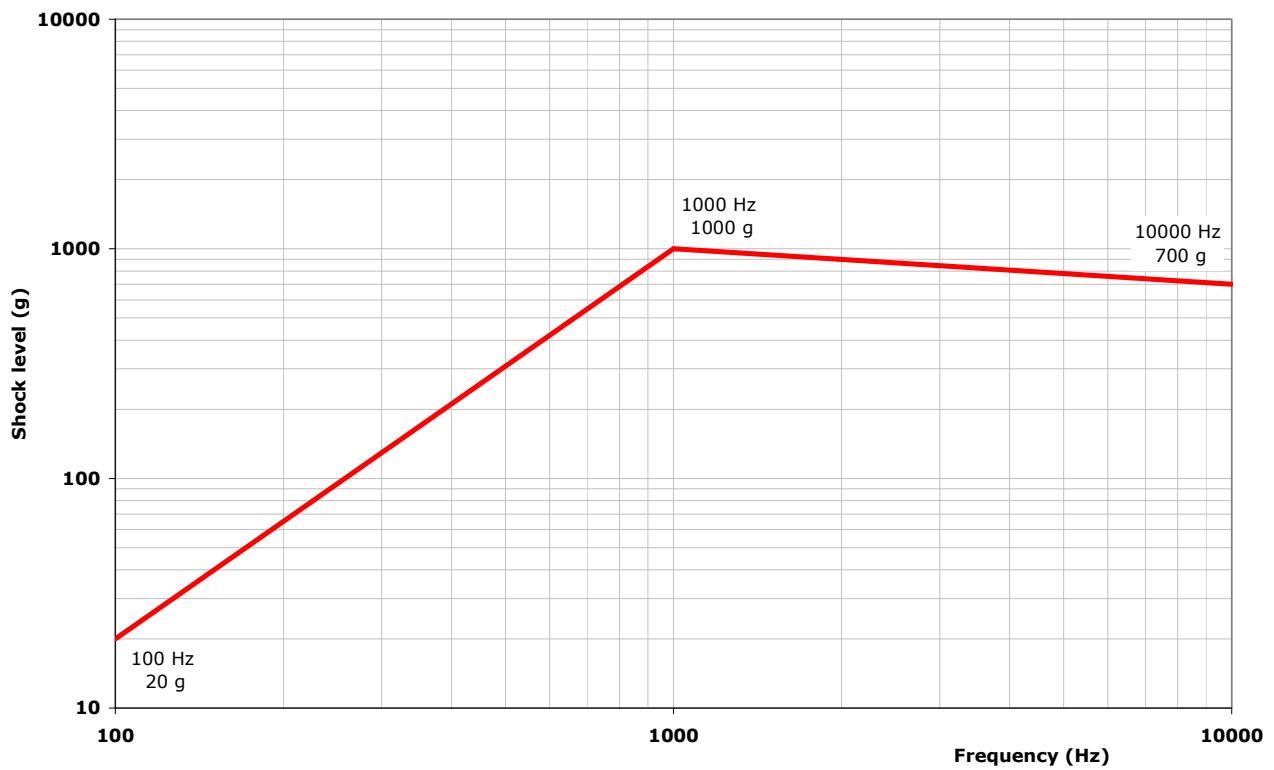

Figure A11.1 – PAS 1666S – Shock spectrum of clamp band release

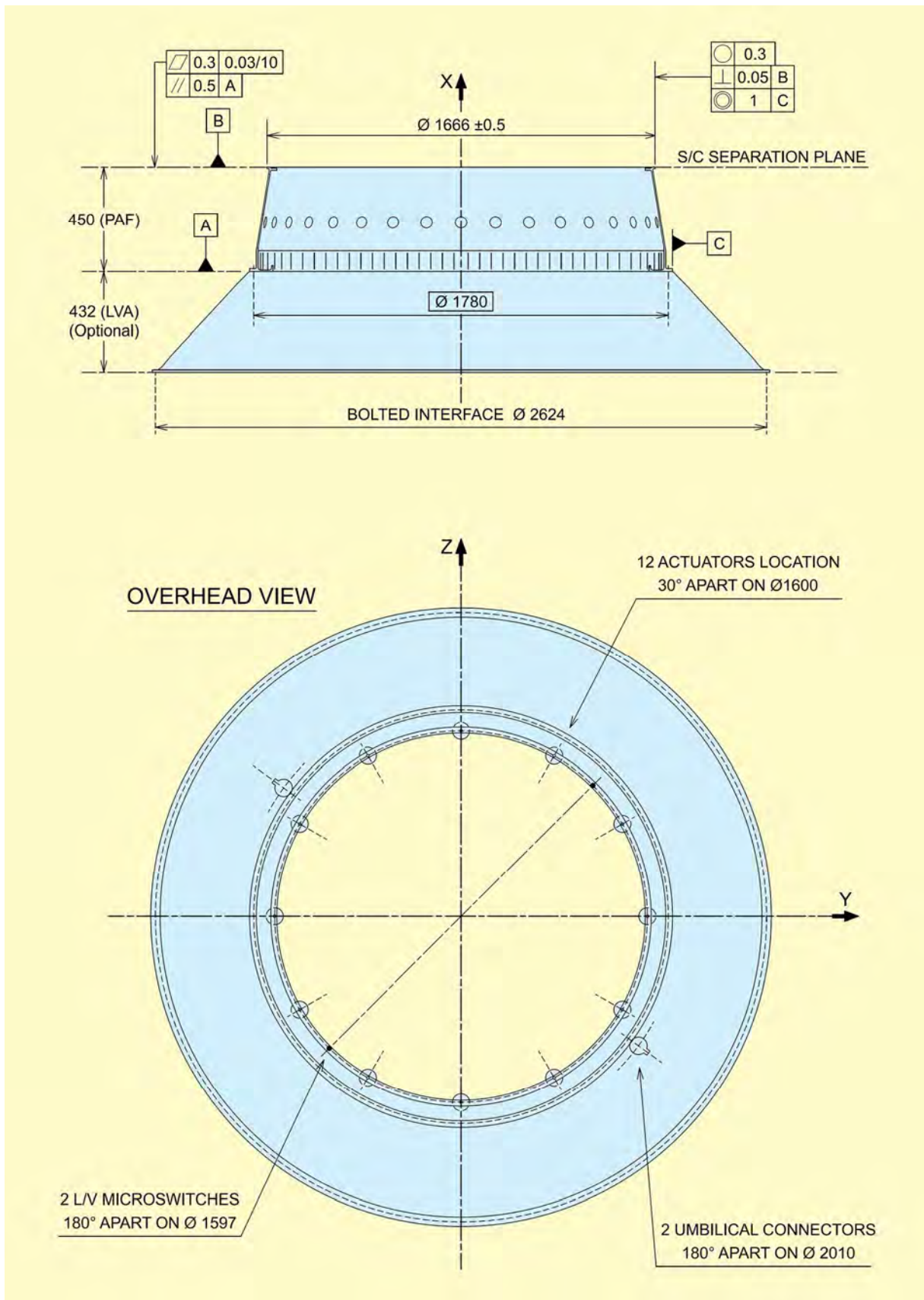

Figure A11.2 – PAS 1666S – General view

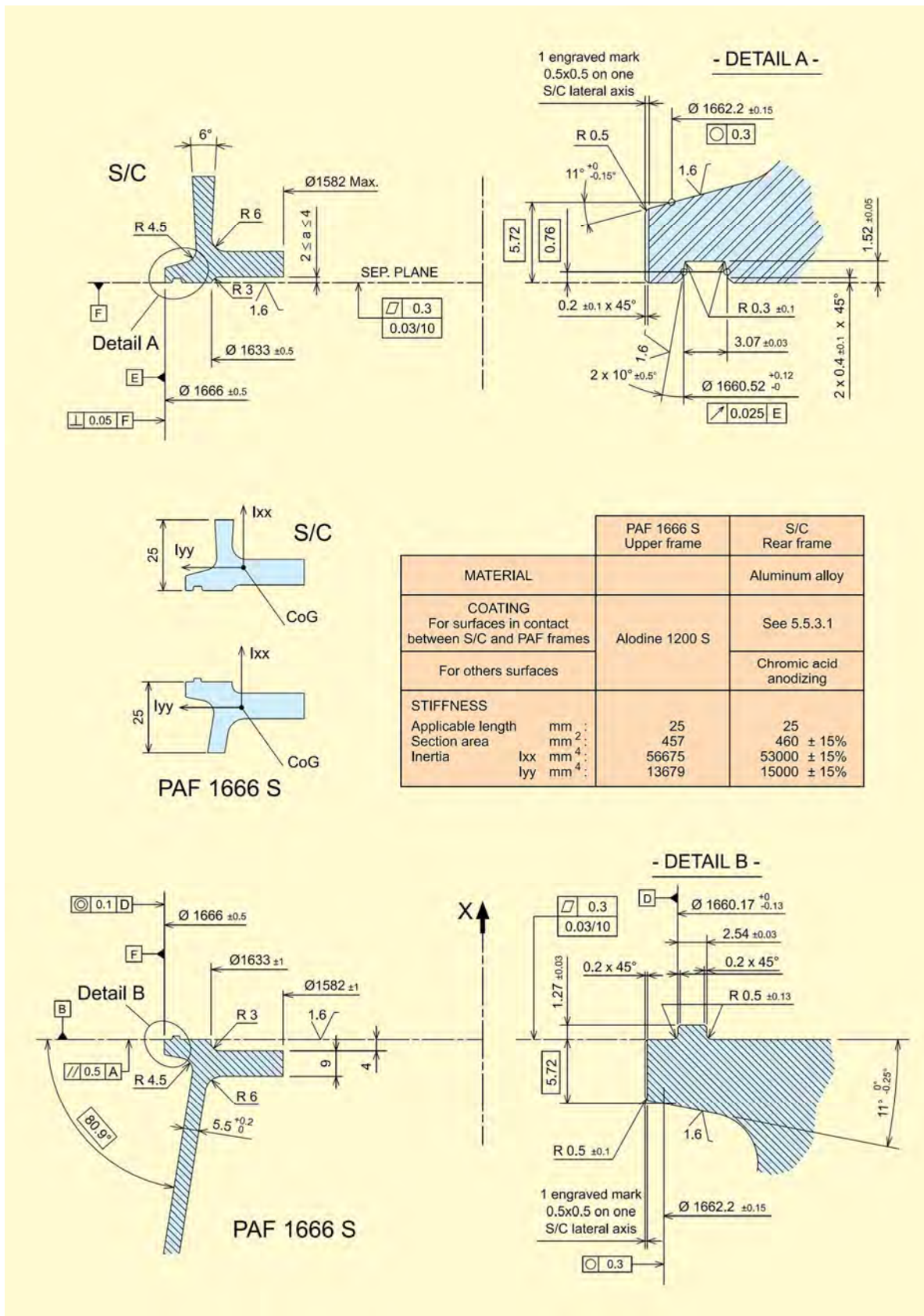

Figure A11.3 – PAS 1666S – Interface frames

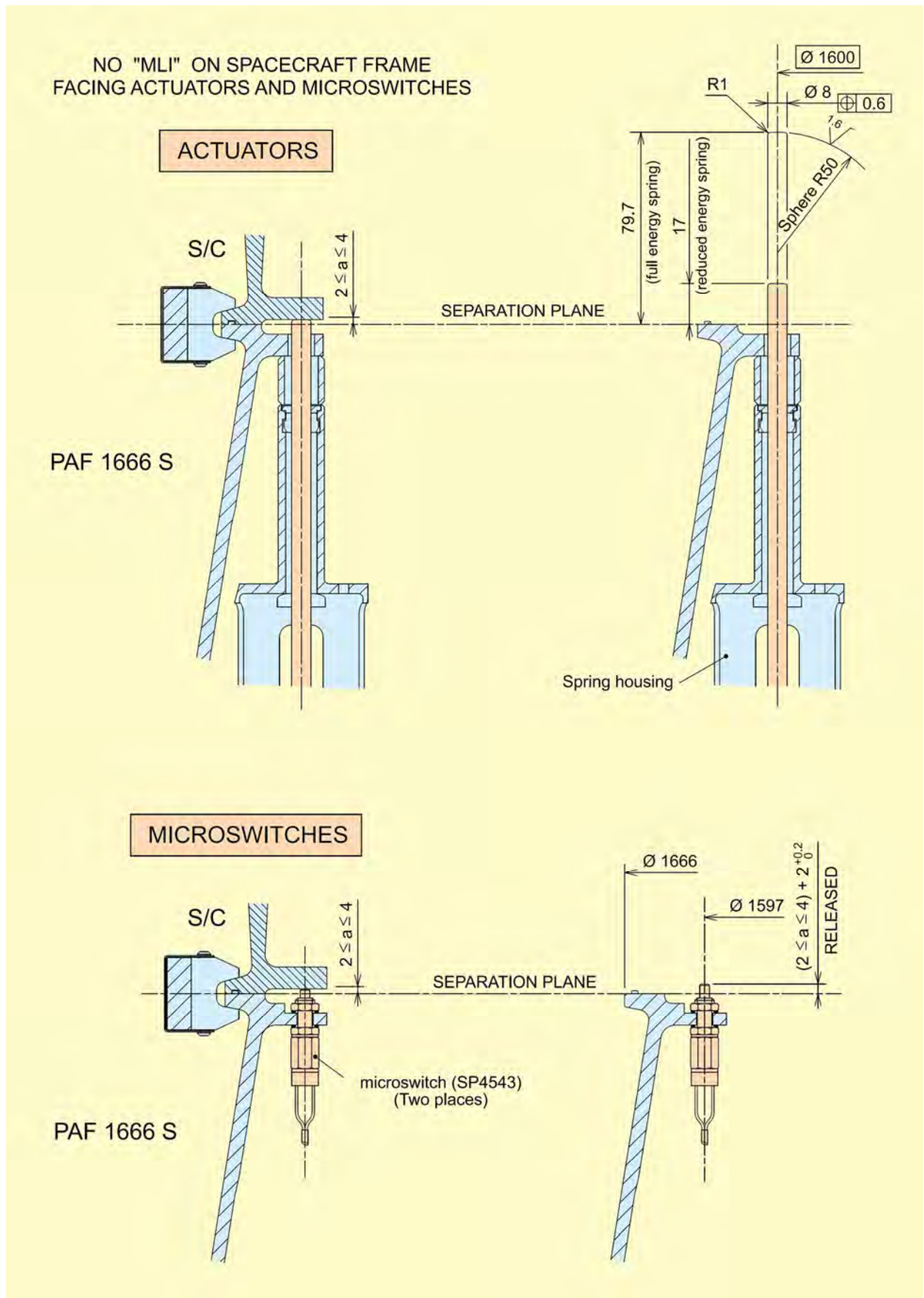

Figure A11.4 – PAS 1666S – Actuators and microswitches

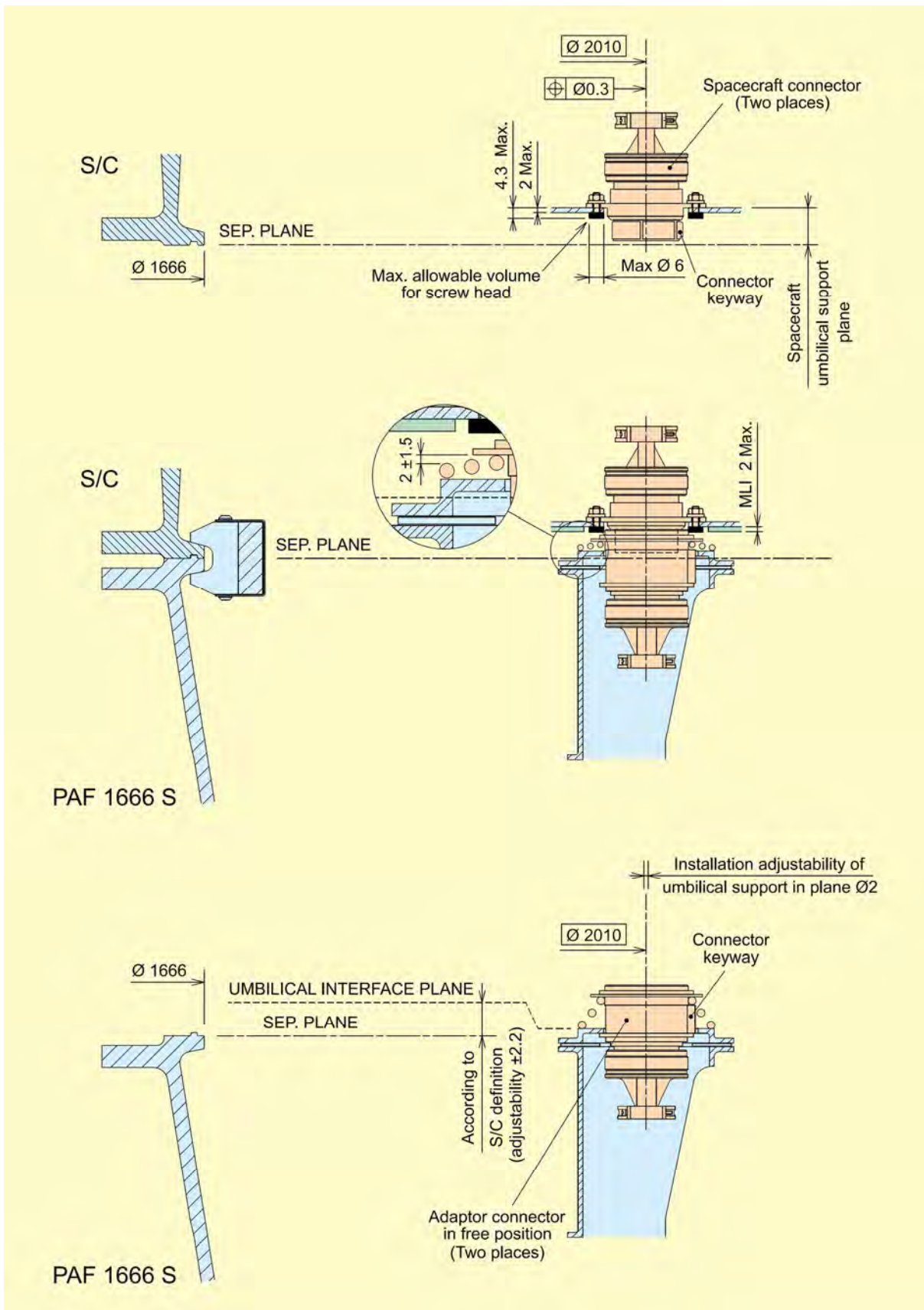

Figure A11.5 – PAS 1666S – Umbilical connectors

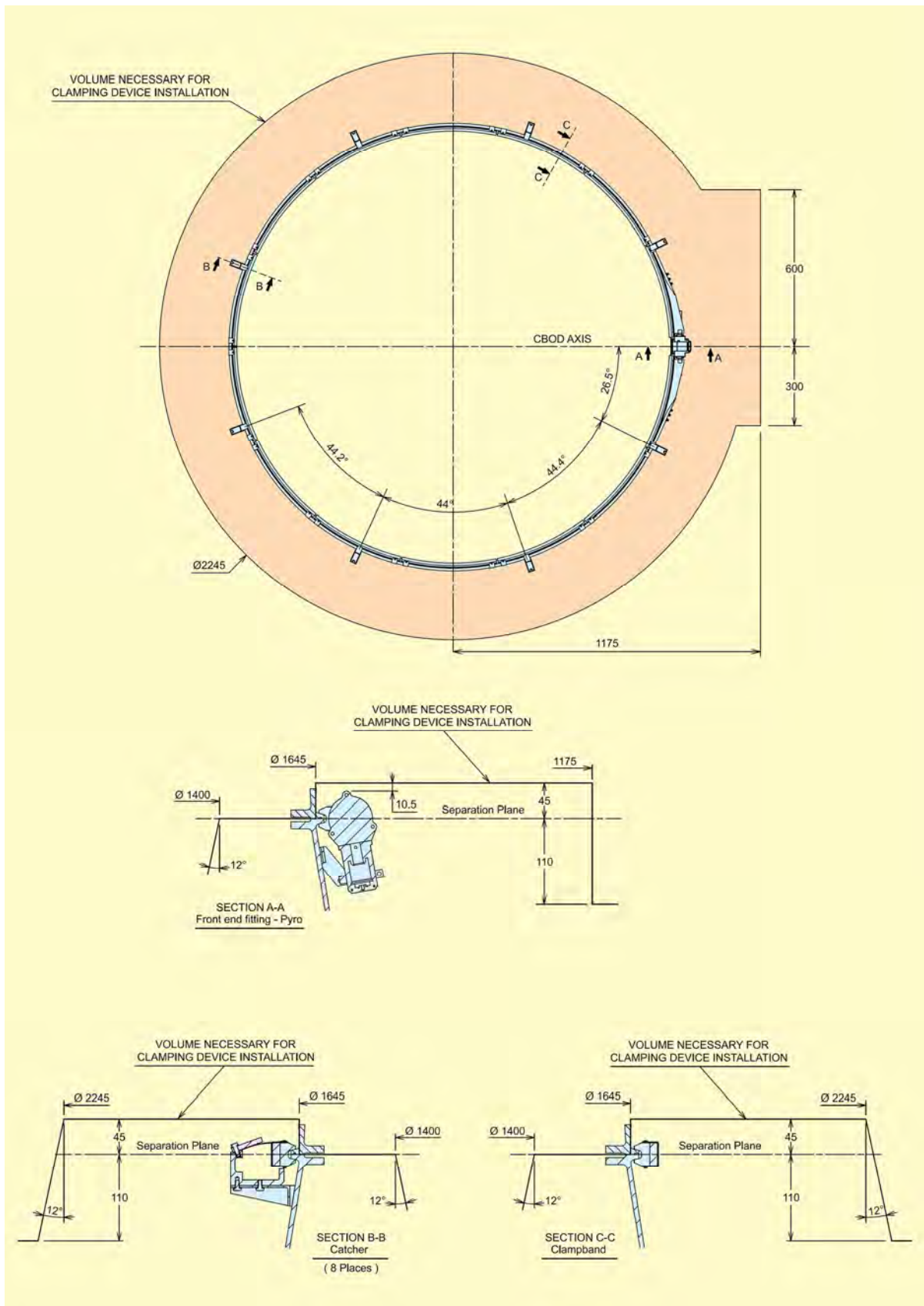

Figure A11.6 – PAS 1666S – Clamping Device Interface

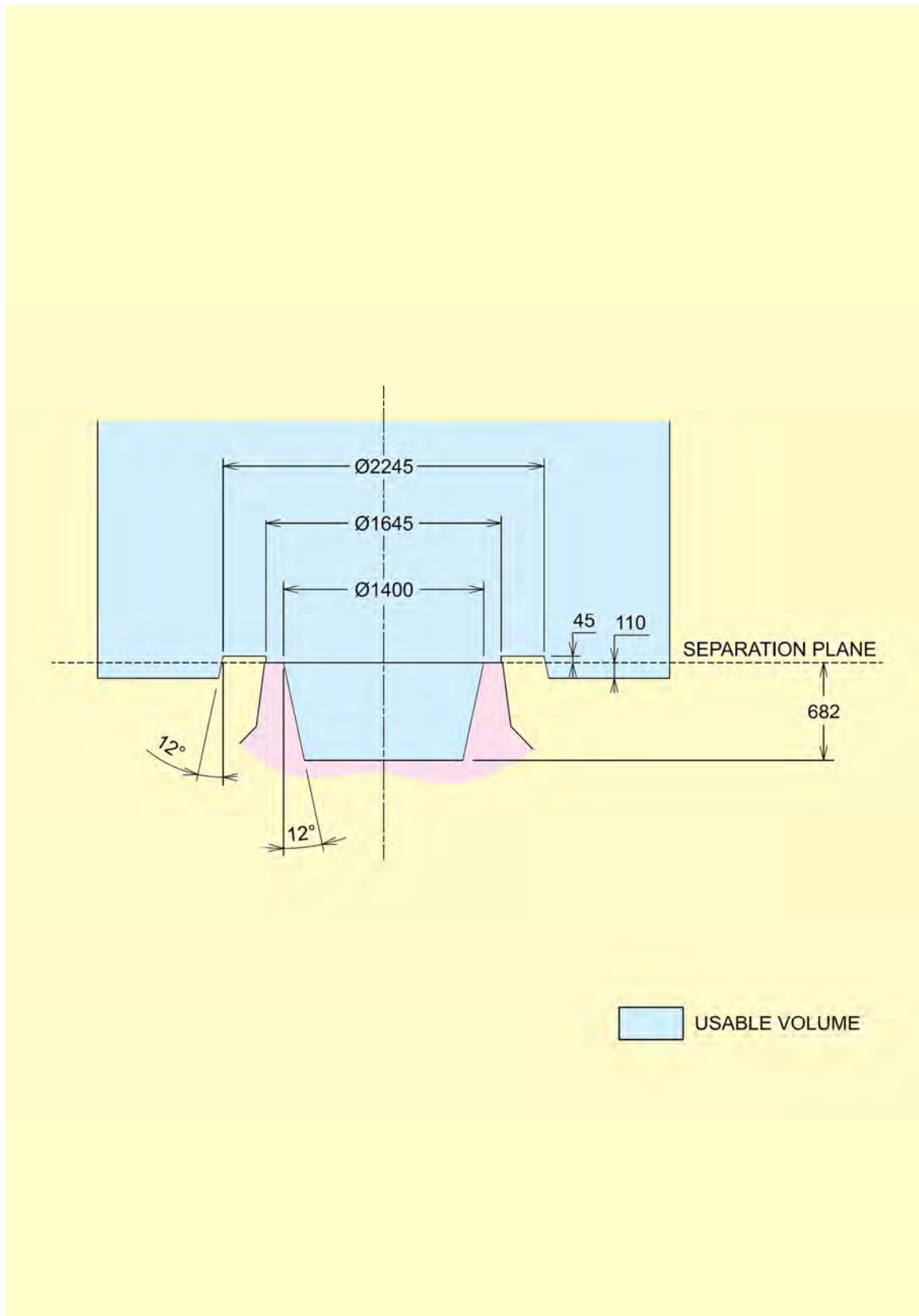

Figure A11.7 – PAS 1666S – Usable volume

Payload Adapter System 2624VS

Annex 12

The PAS 2624VS is mainly composed of:

- a metallic cylindrical structure,
- an upper interface holding the payload at the \varnothing 2624 mm by means of a clamp-band assembly,
- a lower standard interface (\varnothing 2624 mm) with the launch vehicle upper stage or SYLDA 5,
- the separation subsystem, composed of a Clamp-band soft opening device and the separation spring set (4 to 16 internal springs),
- and the electrical subsystem.



There are two variants, currently under development:

- Variant A, with a total height of the structure of 175 mm,
- Variant B: to cover the presence of significant protrusions below the separation plane, the structure has a total height of 325 mm.

The PAS 2624VS is designed and being qualified to support a payload up to 7000 kg centred at 3500 mm from the separation plane.

The PAS 2624VS has a maximum mass of 100 kg for the Variant A and 125 kg for the Variant B.

The spacecraft is secured to the adapter interface frame by a low-shock clamping device.

At separation the spacecraft is forced away from the launch vehicle by a series of actuators (number of springs adjustable from 4 to 16) distributed internally on the circumference of the PAS 2624VS structure.

The force exerted on the spacecraft by each spring does not exceed 1450 N.

For more information please contact Arianespace.

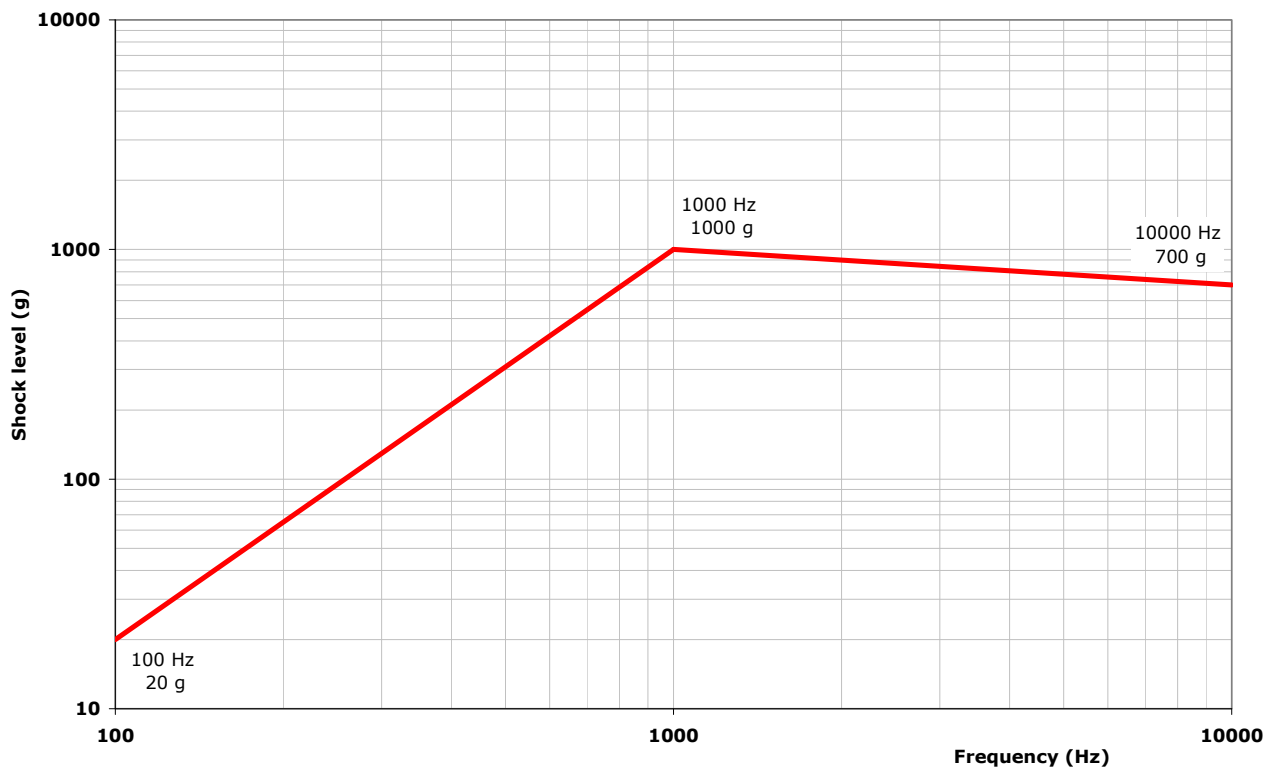

Figure A12.1 – PAS 2624VS – Shock spectrum of clamp band release

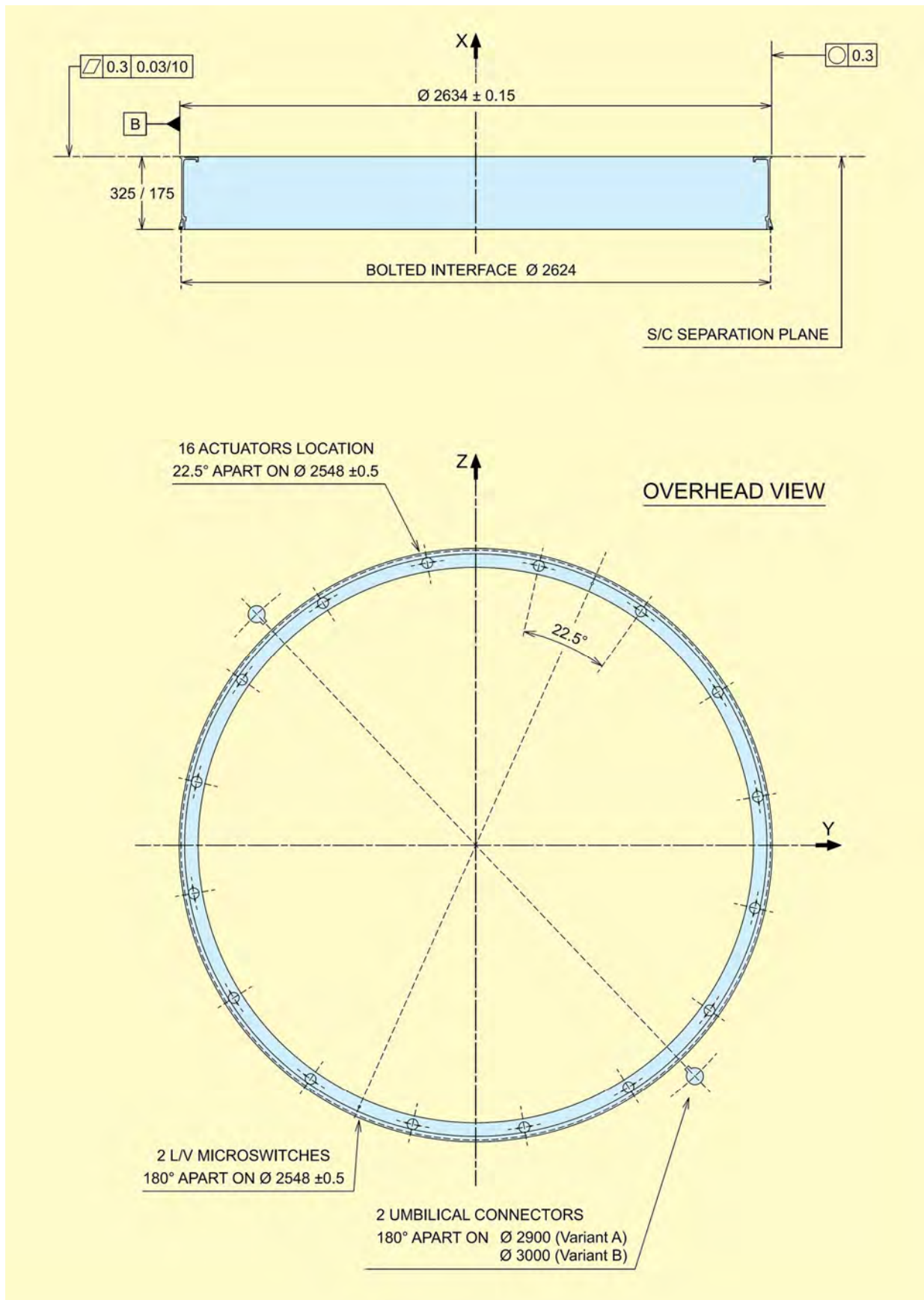

Figure A12.2 – PAS 2624VS – General View

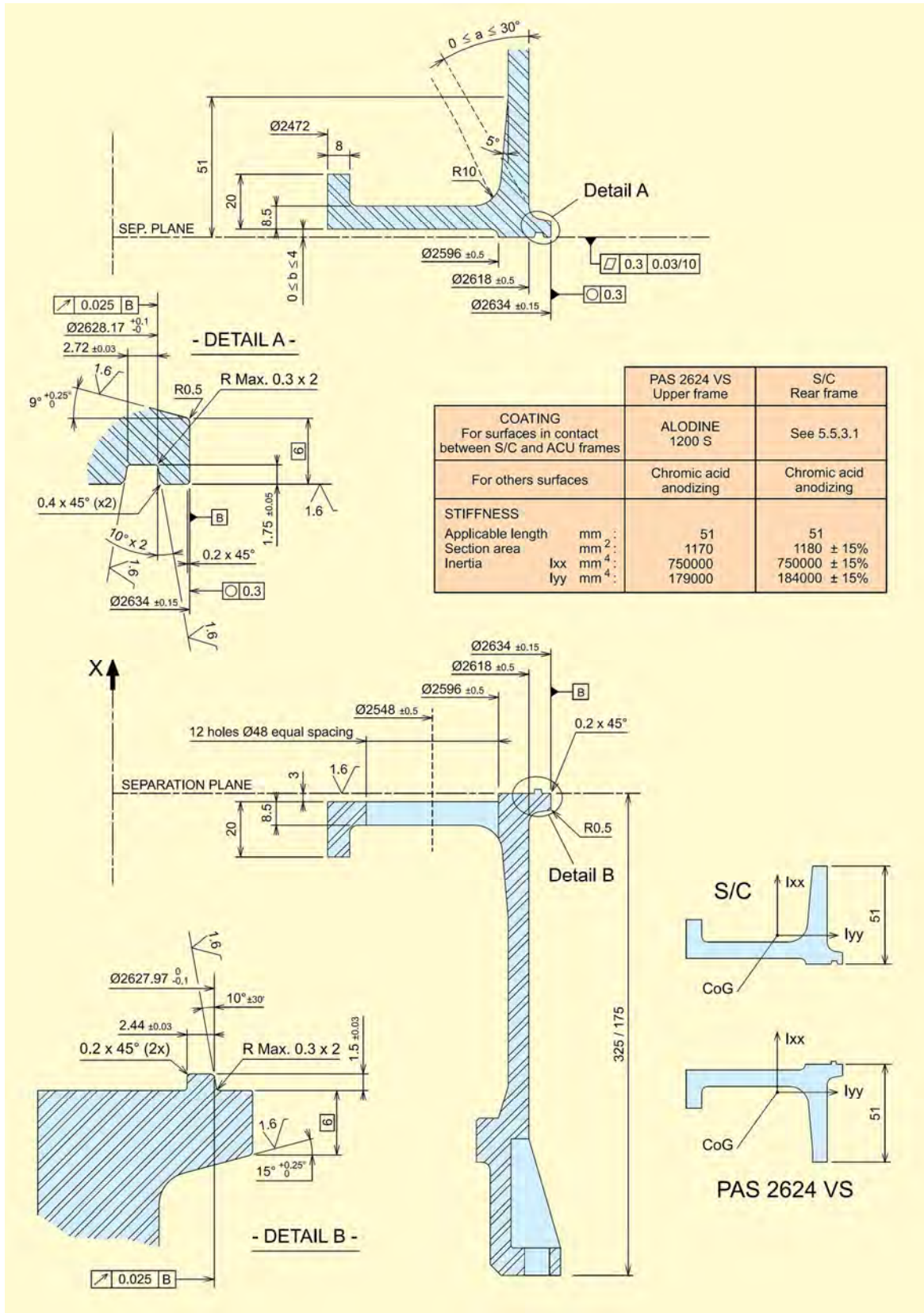

Figure A12.3 – PAS 2624VS – Interface frames

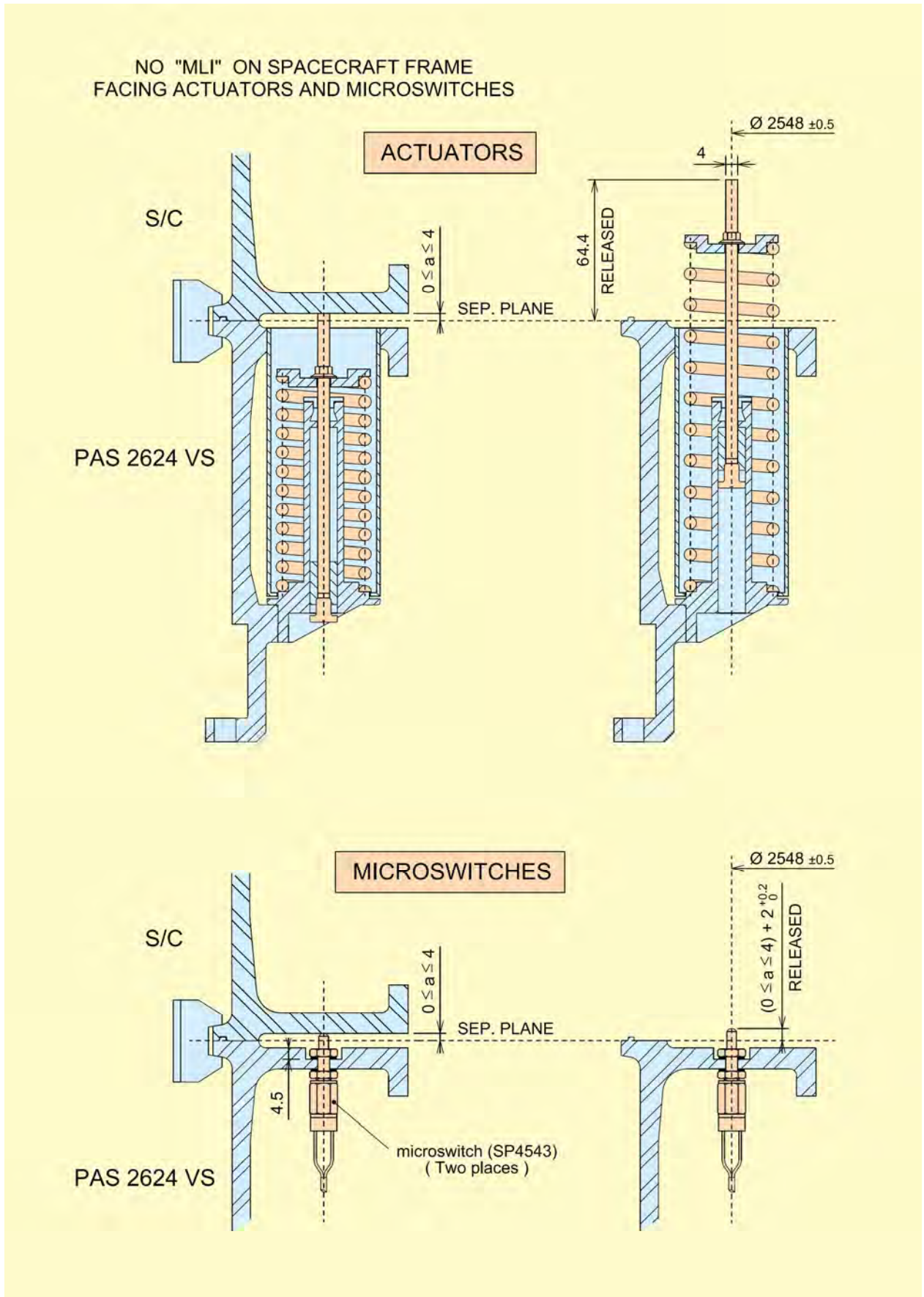

Figure A12.4 – PAS 2624VS - Actuators and Microswitches

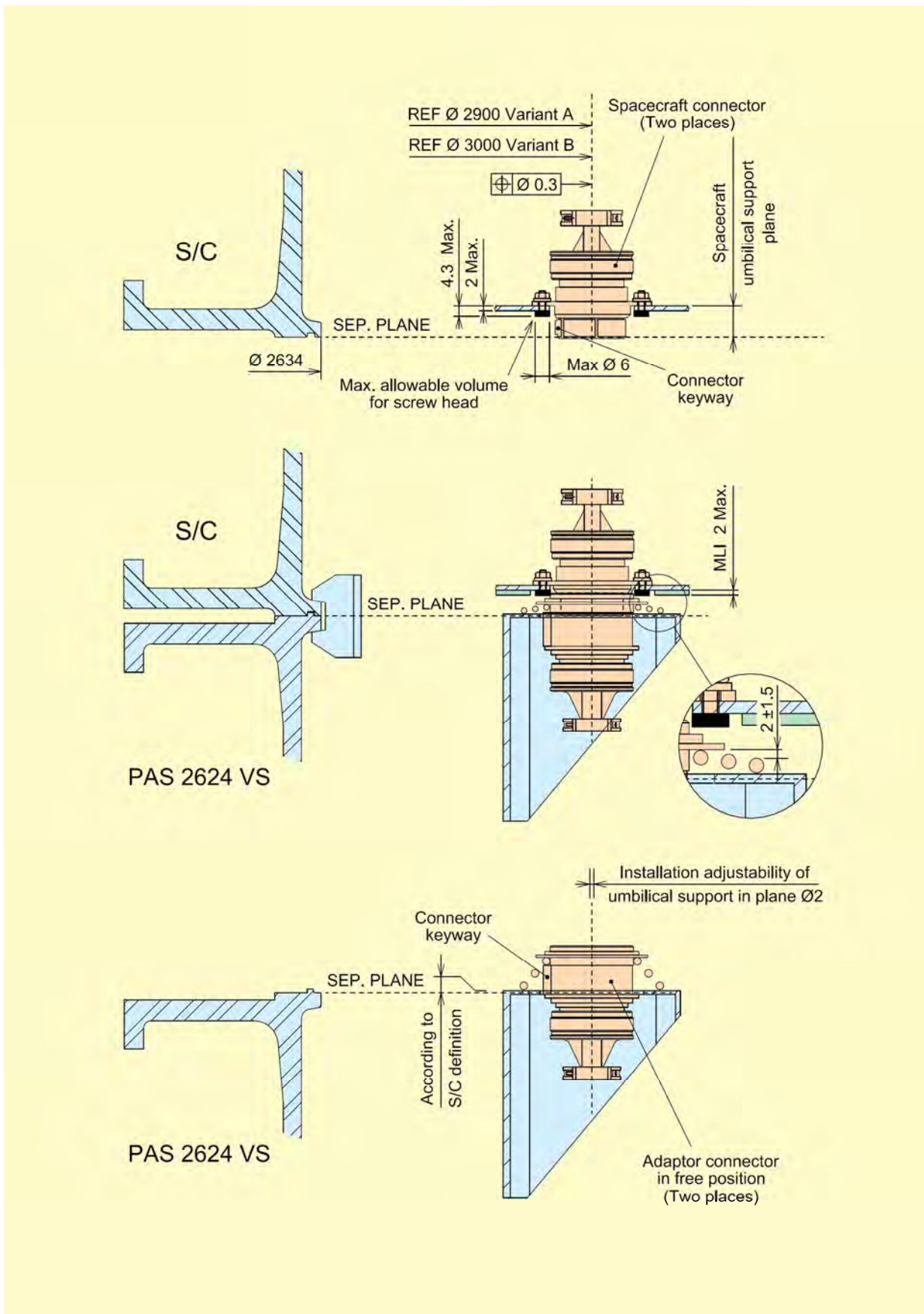

Figure A12.5 – PAS 2624VS – Umbilical connectors

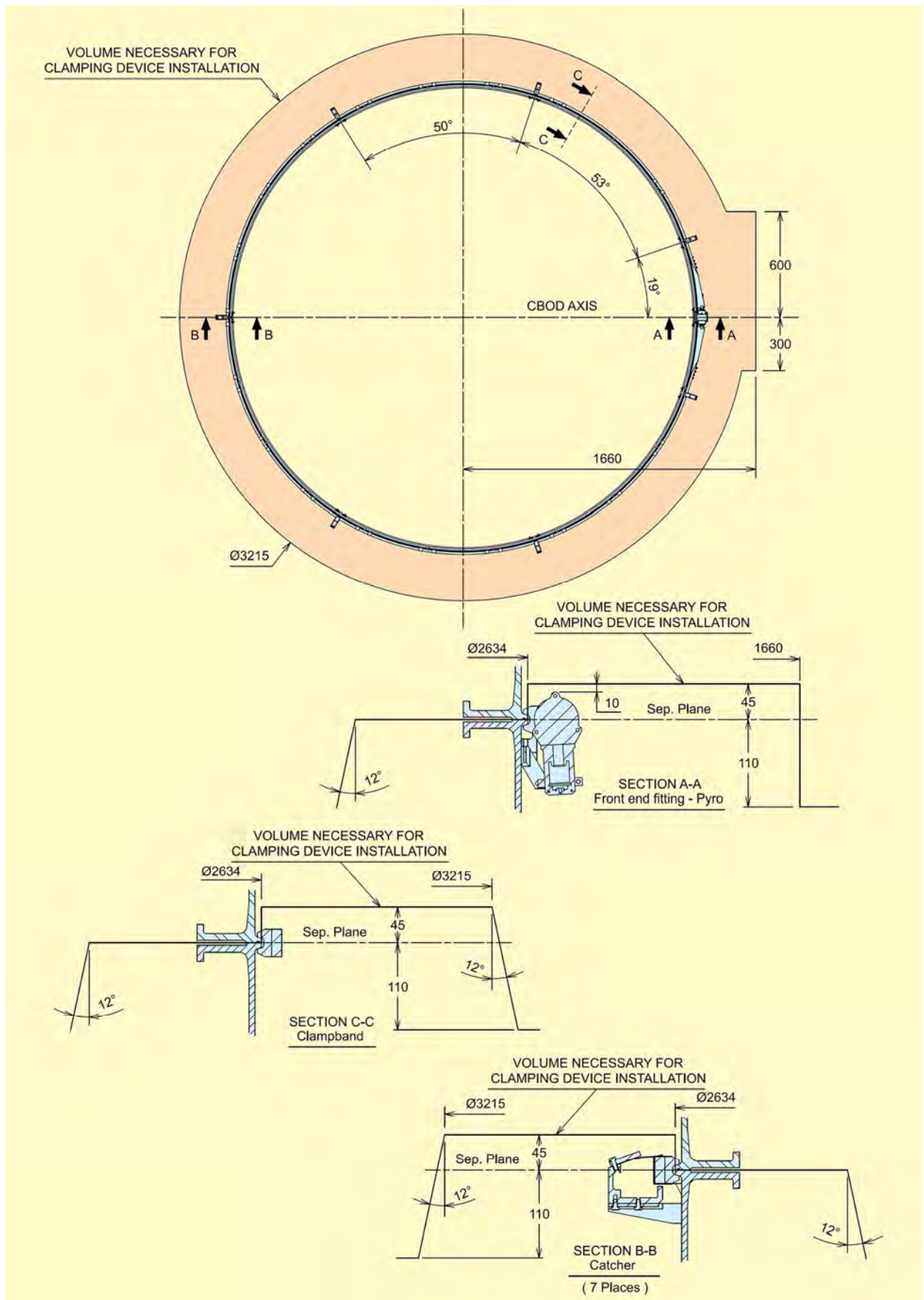

Figure A12.6 – PAS 2624VS – Clamping device interface

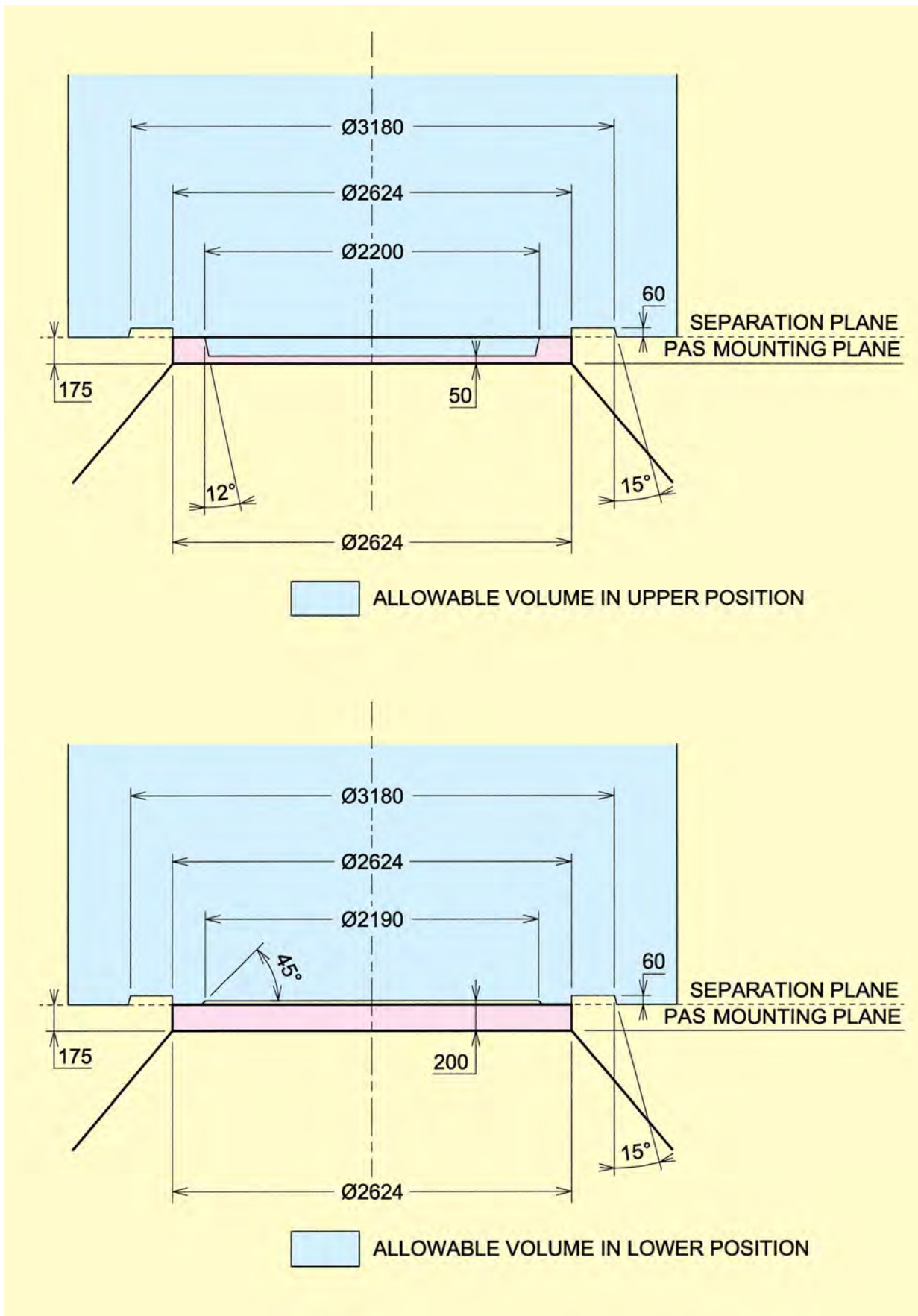

Figure A12.7 – PAS 2624VS - Usable volume for PAS height 175mm

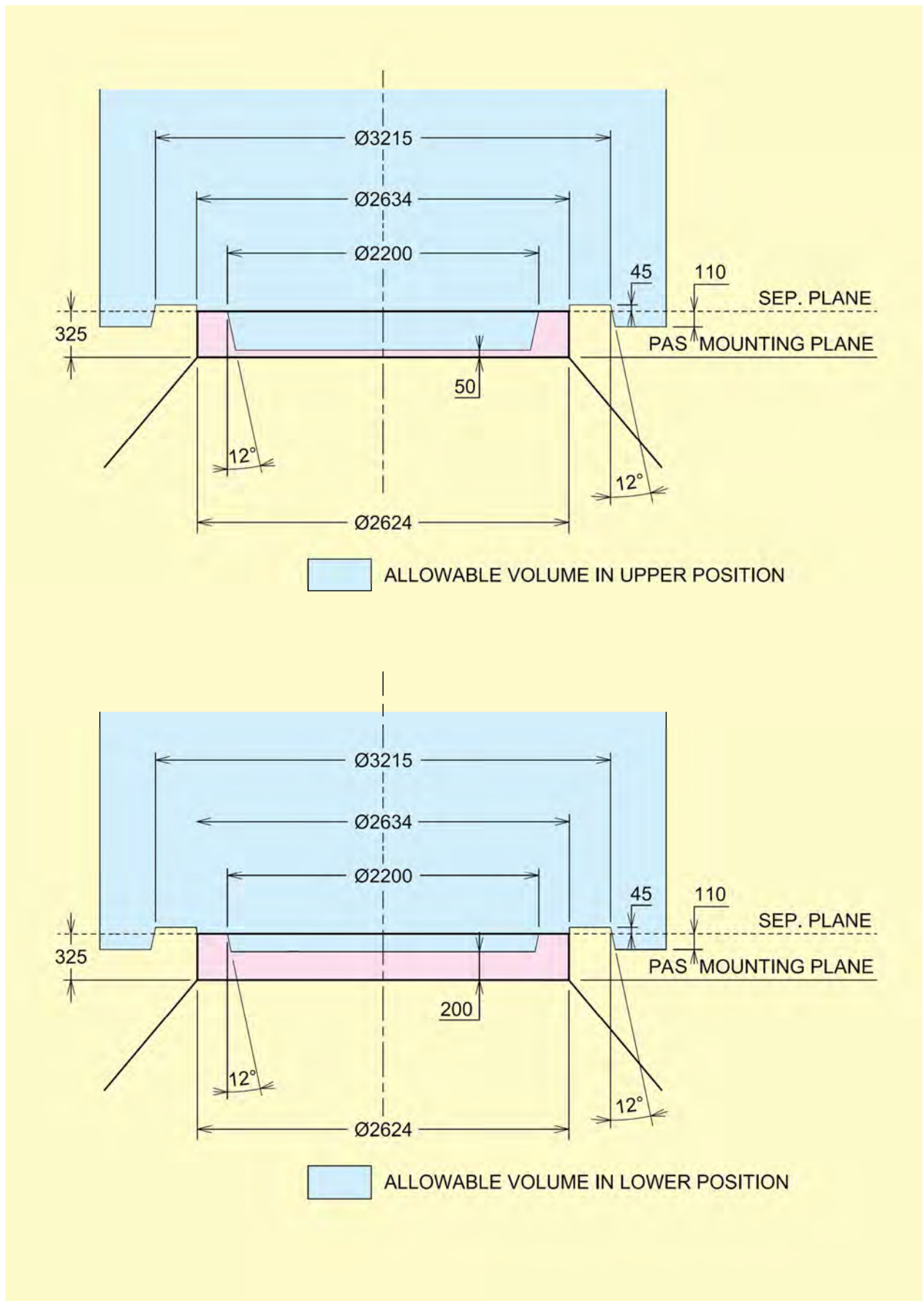

Figure A12.8 – PAS 2624VS - Usable volume for PAS height 325 mm